

# BAHCIVAN

(8182)63-90-72  
+7(7172)727-132  
(4722)40-23-64  
(4832)59-03-52  
(423)249-28-31  
(844)278-03-48  
(8172)26-41-59  
(473)204-51-73  
(343)384-55-89  
(4932)77-34-06  
(3412)26-03-58  
(843)206-01-48

(4012)72-03-81  
(4842)92-23-67  
(3842)65-04-62  
(8332)68-02-04  
(861)203-40-90  
(391)204-63-61  
(4712)77-13-04  
(4742)52-20-81  
(3519)55-03-13  
(495)268-04-70  
(8152)59-64-93  
(8552)20-53-41

(831)429-08-12  
(3843)20-46-81  
(383)227-86-73  
(4862)44-53-42  
(3532)37-68-04  
(8412)22-31-16  
(342)205-81-47  
- - (863)308-18-15  
(4912)46-61-64  
(846)206-03-16  
- (812)309-46-40  
(845)249-38-78

(4812)29-41-54  
(862)225-72-31  
(8652)20-65-13  
(4822)63-31-35  
(3822)98-41-53  
(4872)74-02-29  
(3452)66-21-18  
(8422)24-23-59  
(347)229-48-12  
(351)202-03-61  
(8202)49-02-64  
(4852)69-52-93



# BASIC CONCEPTS

BASIC CONCEPTS

FAN SELECTION

FAN CURVE READING

FAN LAWS

BASIC FORMULAS

CONNECTION DIAGRAMS

# BASIC CONCEPTS

## BASIC CONCEPTS

**AIRFLOW(Q):** : The air quantity transferred by fan in the unit of time. It is commonly expressed with the units of m<sup>3</sup>/h, m<sup>3</sup>/s or C.F.M.  
1 m<sup>3</sup>/h = 3600 m<sup>3</sup>/s  
1 C.F.M. = 1,7 m<sup>3</sup>/h

The maximum fan flow rate is the flow rate during the moment when fan provides free air flow throughout the shot line of the fan without any barrier in front of it. The maximum fan flow rate given in the technical specifications expresses the state under this circumstance.

**NUMBER OF REVOLUTIONS(N):** The revolution of rotating field occurring in stator within one minute. It is commonly expressed with the units of min. or Rpm.

**PRESSURE(P):** The force to which the air is exposed per unit area and which affects the flow reversely during the transfer of air by fan through the enclosed volume (such as air ducts). It is expressed as Pa or mmSS in the characteristic curves of fan.  
1 Pa = 1 N/m<sup>2</sup>  
1 mmSS = 9,8 Pa

**STATIC PRESSURE(Ps):** The forces affecting the unit area due to the effects of frictional force in the internal walls of the duct in the duct where the air flow occurs as well as effects of the equipments (such as damper, muffler, vent-hole and filter) installed in the duct.

**DYNAMIC PRESSURE(Pd):** The force affecting the unit area due to air flow velocity.

**TOTAL PRESSURE (PT):** The total of static and dynamic pressures.  
PT = Ps + Pd

**SOUND LEVEL (dB):** Fans emit sound wave around during the operation due to vibration. The said emitted sound waves reduce depending on the distance as getting away from the fan.

**INPUT POWER (W):** The force pulled by motor from the network. The unit of it is W or kW.  
1 HP = 0,75 kW

**TEMPERATURE (T):** The ambient conditions whose temperature is not higher than +40°C, whose height is maximum 1000 m(included) and whose relative humidity is not higher than 95% are considered as standard ambient conditions.

INSULATION CLASS	HEAT INCREASE LIMIT (K)
A	65
E	80
	90
F	115
H	140

The most important factor for the resistance of the insulating materials used for the winding insulation of asynchronous motors is temperature. The insulating materials are divided into classes in the standards in order to ease the selection of appropriate insulating material for the application. Asynchronous motor windings are generally in the insulation class of B,F and sometimes H.

## FAN SELECTION

The information which should be obtained by fan manufacturer from the facility authorizer for a right fan selection,

1. Air flow rate ( $m^3/h$ ,  $m^3/s$  veya CFM),
2. Static and total pressure required in the operation conditions (Pa or mmSS),
3. The temperature of air ( $^{\circ}C$ ) passing through the fan,
4. The features of air to be carried by the fan (dust, humidity, wood chips etc.),
5. Whether the air passing through the fan is corrosive or not,
6. The permanent or temporary operation of business enterprise.

$$\text{Air Flow Rate (m}^3\text{/h)} = \text{Air Change Coefficient (1/hour)} \times \text{Location Volume (m}^3\text{)}$$

LOCATION	AIR CHANGE COEFFICIENT (1/Hour)	LOCATION	AIR CHANGE COEFFICIENT (1/Hour)
Auditoriums	6-8	Laundries	10-20
Classrooms	5-8	Offices	4-8
Libraries	4-5	Indoor Swimming Pools	3-4
Paint Furnaces	25-50	Restaurants	8-12
Safe Box Rooms	3-6	Conference Rooms	6-8
Cinemas and Theatres	5-8	Waiting Rooms	4-6
Domestic Kitchens	15-25	Photocopy Rooms	10-15
Commercial Kitchens	15-30	Machinery Rooms	10-40
Bathrooms	5-7	Stores	4-8
Domestic wcs	4-5	Dry Cleaning	5-15
General wcs	8-15	General Malate Sites	4-8
Meeting Halls	6-8	General Change Rooms	6-8
Foundries	8-15	Rolling Mill	8-12
Gyms	4-6	Laboratories	8-15

In the characteristic curve of fan above: The operation point of the fan operating in the air flow rate of  $150 m^3/h$  and under the pressure of  $162 Pa$  is indicated in the green area. The red area on the top part of the characteristic curve of fan is the one which is not appropriate for fan selection.

The curves are formed by subjecting each fan model to flow rate and pressure tests and by entering the obtained data into the coordinate axis. The fan curves were formed as static pressure-flow rate axis in order to ease the fan selection. The maximum air flow rate given in the technical specifications is the flow rate under zero static pressure state. This is also called as the free shot state of the fan.

During selection, the closest operation point must be taken into consideration. Attention must be paid to make selection from top and bottom limit points of the curve.

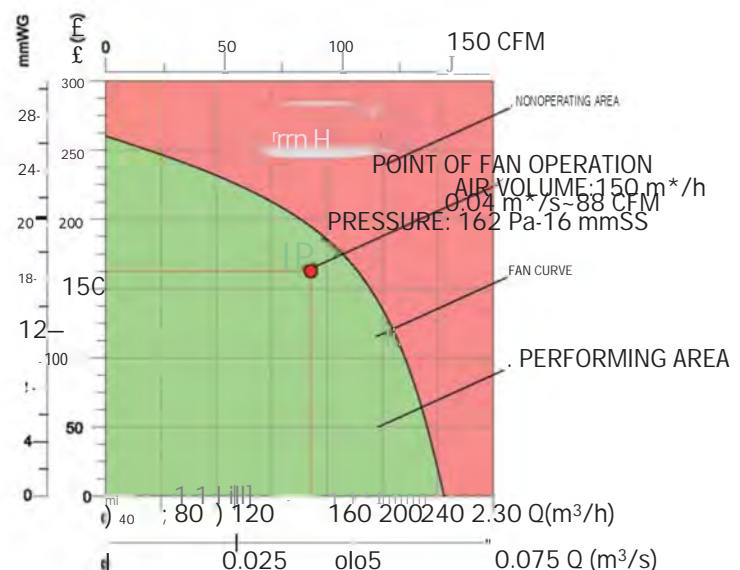

# BASIC CONCEPTS

## CHARACTERISTIC CURVES OF BELT AND PULLEY DRIVEN FANS

### EXAMPLE FAN CURVE READING

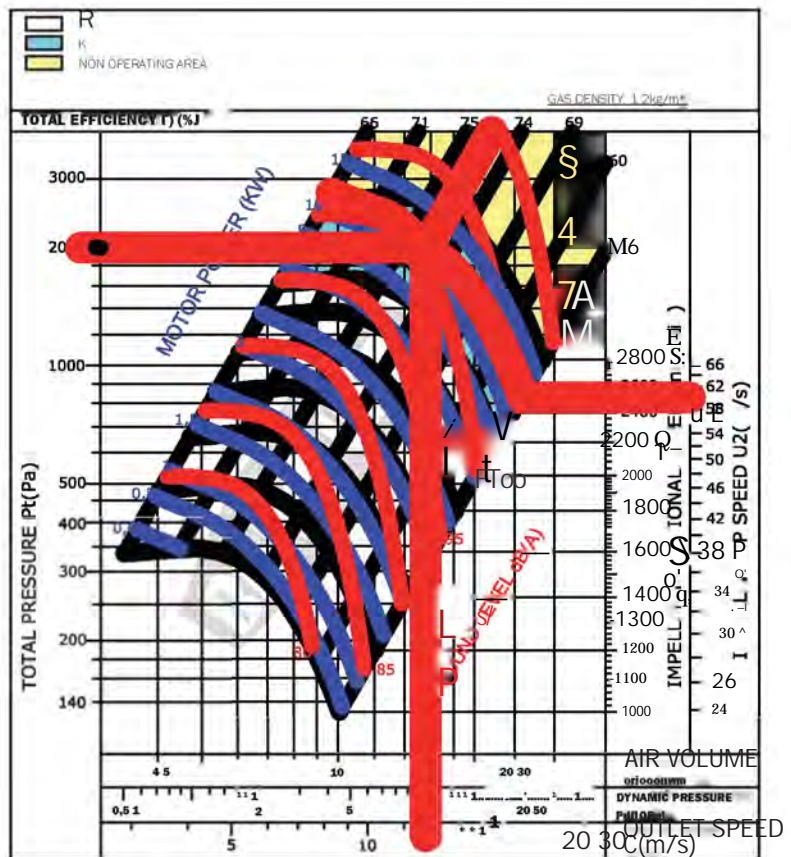

AIR VOLUME  $V = 16000 \text{ m}^3/\text{h}$

TOTAL PRESSURE  $P_t = 2000 \text{ Pa}$

DYNAMIC PRESSURE  $p_d = 11 \text{ Pa}$

OUTLET SPEED  $C = 13,5 \text{ m/s}$

NUMBER OF SPEED  $n = 2500 \text{ d/d}$

BLADE SPEED  $U_2 = 60 \text{ m/s}$

POWER  $P_w = 1 \text{ a Kw}$

SOUND LEVEL  $L_{wi} A = 102 \text{ dB(A)}$

EFFICIENCY  $h = \%74,5$

## FAN LAWS

	CHANGE OF SPEED	CHANGE OF AIR DENSITY
AIR VOLUME	$Q_2 = Q_1 \left(\frac{N_2}{N_1}\right)$	DO NOT CHANGE
PRESSURE	$P_2 = P_1 \left(\frac{N_2}{N_1}\right)^2$	$P_2 = P_1 \left(\frac{\rho_2}{\rho_1}\right)$
POWER	$N_2 = N_1 \left(\frac{N_2}{N_1}\right)^3$	$N_2 = N_1 \left(\frac{\rho_2}{\rho_1}\right)^{1.5}$

## BASIC FORMULAS

$$P_t = P_{st} + P_{dy}$$

$$V = A \cdot (m/sn)$$

$$Q = m^3/sn \quad A: m^2$$

$$C_d = \frac{Q}{A \cdot V} \quad (Eq) \quad d: (mm/SS)$$

$$V: m/sn \quad d: kg/m^3$$

$$N_{fa} = \frac{Q \cdot P_t}{746} \quad (HP)$$

$$V_{enm} = \frac{A \cdot f_{en}}{n} \quad (m)$$

$$\text{Output Power for Three Phase Motor} = \frac{P_t \cdot \sqrt{3}}{1000} \quad (kW)$$

$$\text{input Power for Three Phase Motor} = \frac{P_t}{\eta} \quad (kW)$$

$$\text{Output Power for Single Phase Motor} = \frac{P_t}{1000} \quad (kW)$$

$$\text{Input Power for Single Phase Motor} = \frac{P_t}{\eta} \quad (kW)$$

Output power is the power which main electric network supply to the motor.  
Input power is the mechanical power at motor shaft after losses.

Rectangular shaped (axb) duct's equivalent multiplication can be calculated with following formula.

$$D = 1.265 \sqrt{\frac{(axb)^3}{V(a+b)}} \quad (mm) \quad a: mm \quad b: mm$$







# BASIC CONCEPTS

CODES	CONNECTION DIAGRAMTYPE												
	1	2	3	4	5	6	7	8	9	10	11	12	13
4M 250B													
4M 300B													
4T300B													
4M 350B													
4T350B													
4M 400B													
4T 400S													
4M 450B													
4T 450B													
4T 450S													
4M 500B													
4T 500B													
B6 PAM 250													
B6 PAM 300													
B6 PAM 350													
B6 PAM 400													
B6 PAM 450													
B6 PAM 500													
B5PAM (MONOFAZE :)													
B5PAT (TRIFAZE)													
BSM 250													
BSM 300-350													
BSM 400-450													
BSM 500 -550-600													
BA7M (MONOFAZE )													
BA 7T (TRIFAZE)													
BTFM (MONOFAZE)													
BTFM (TRIFAZE)													
BASSF 120-60													
BASSF 140-60													
BASSF 160-60													
BASSF 200-80													
BASSF 225-90													
BASSF 250-100													
BASSF 280-112													
BASSF 315-125													
BASSF 355-140													
BDRAS 85-40													
BDRAS 108-50													
BDRAS 120-60													
BDRAS 140-60													
BDRAS 160-60													
BDRS 125-50													
BDRS12060													
BDRS 140-60													
BDRS 160-60													
BPS 140-60													
BPS-B 150-100													
OBR 140M-2K													
OBR 200M-2K													
OBR 200M4K													
KMS													
KTS													
ALQ (MONOFAZE)													
ALQ (TRIFAZE)													
BGSS-(MONOFAZE)													
BGSS-(TRIFAZE)													
BORKA (MONOFAZE :)													
BORKA (TRIFAZE)													
BSC-1													
BSC-2													

Only wire colors has been changed on the diagram 3 and 4.

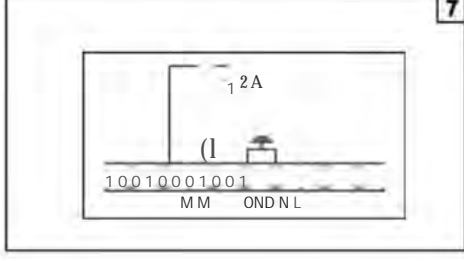
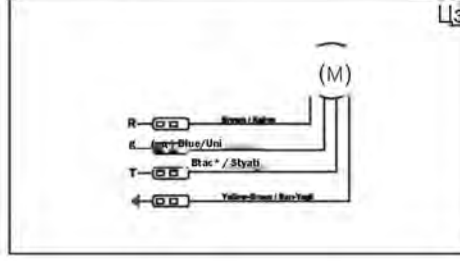
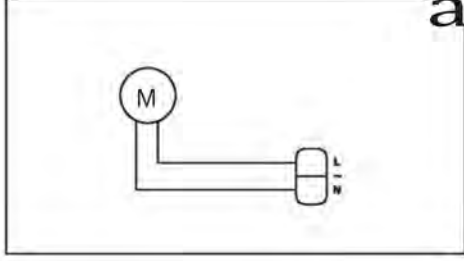
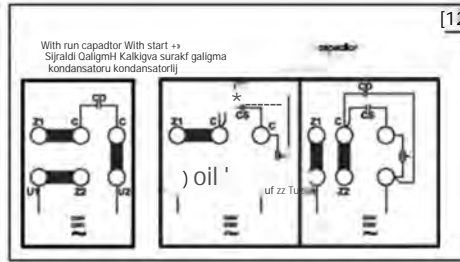
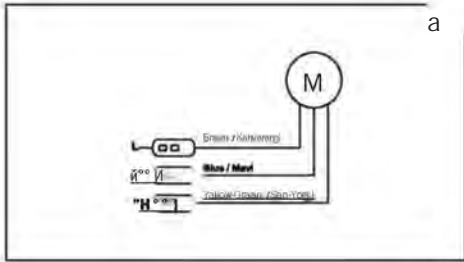
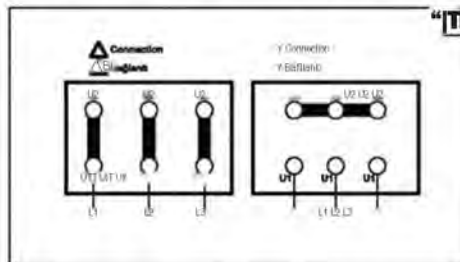
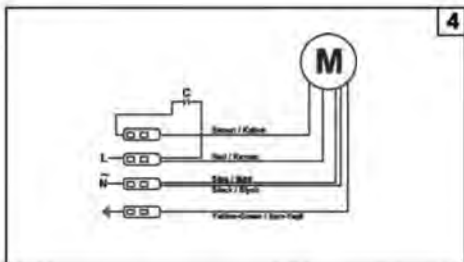
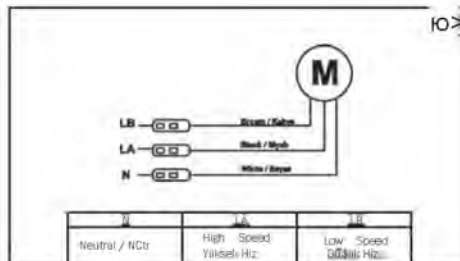
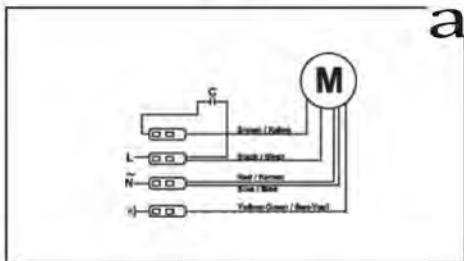
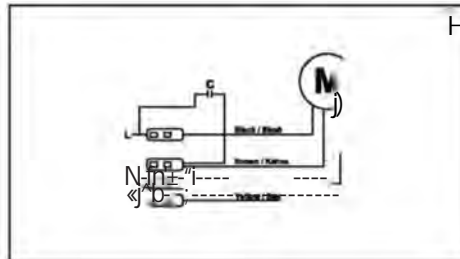
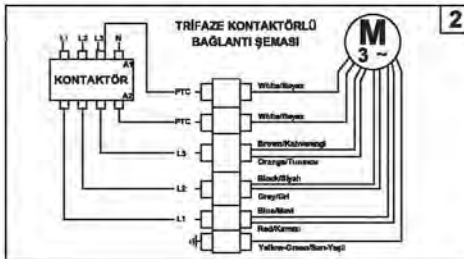
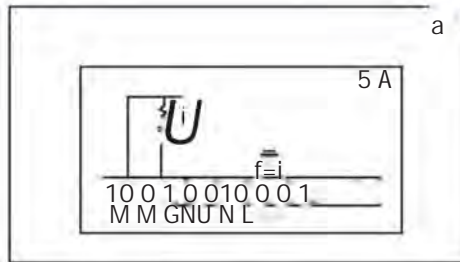
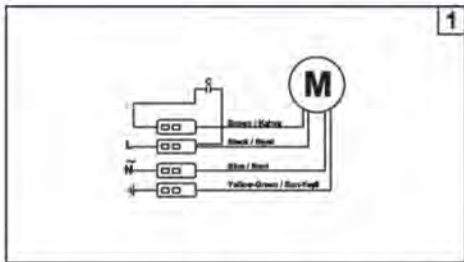

# INDEX

- DUCT FANS
- ROOF FANS
- AXIAL FANS
- RADIAL FANS
- PLASTIC FANS
- VENTILATORS
- SMOKE EXHAUST SYSTEMS
- ACCESSORIES

# INDEX

## DUCT FANS

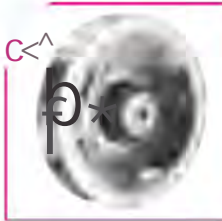

**BDRKF**  
Centrifugal Motorized Impellers  
Backward Curved  
300 - 11000 m<sup>3</sup>/h

3G



**BDTX**  
Centrifugal In Line Duct Fans  
Backward Curved  
240 - 1700 m<sup>3</sup>/h

34

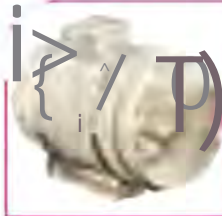

**BMFX**  
In Line Duct Fans  
Mixed Flow  
165 - 2000 m<sup>3</sup>/h



**BPX**  
In Line Duct Fans  
Plastic Housing  
410 m<sup>3</sup>/h

40



**BFTX**  
Wall Mounted Duct Fans  
Backward Curved  
250 - 1900 m<sup>3</sup>/h

42



**BDKF**  
Rectangular In Line Duct Fans  
Backward Curved  
450 - 9000 m<sup>3</sup>/h

44



**BDKF-R**  
Direct Drive Rectangular In-Line  
Duct Fans / Backward Curved  
3000 - 10000 m<sup>3</sup>/h  
1200C

48

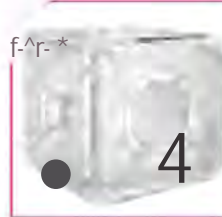

**BKKf \ 1**  
Square Duct Fans  
Backward Curved  
3900 - 4200 m<sup>3</sup>/h

5G



**BSKF**  
Rectangular In Line Duct Fans  
Forward Curved  
990 - 4250 m<sup>3</sup>/h

52



**BSKF-R**  
Direct Drive Rectangular In-Line  
Duct Fans / Forward Curved  
3000 - 10500 m<sup>3</sup>/h  
120°C

54



**BKEF**  
Kitchen Exhaust Fans  
Backward Curved  
2150-5000 m<sup>3</sup>/h  
120°C

5aJ



**BKEF-T**  
Kitchen Exhaust Fans  
Forward Curved  
750 - 6000 m<sup>3</sup>/h  
120°C

60



**BKEF-R**  
Kitchen Exhaust Fans  
Backward Curved  
4000 - 10500 m<sup>3</sup>/h  
120°C

64



**BHV**  
Ventilation Units / Belt Drive  
Forward Curved  
1800 - 20000 m<sup>3</sup>/h

66^



**BHV-R**  
Ventilation Units / Belt Drive  
Backward curved  
4600 - 22400 m<sup>3</sup>/h

76



ROOF FANS



**BRF**  
Centrifugai Roof Fans  
Horizontal Outlet  
350 - 9600 m<sup>3</sup>/h



**BRCF**  
Direct Drive Roof Fans  
Horizontal Outlet  
1000 - 16000 m<sup>3</sup>/h  
120°C



**BRCF-M**  
Direct Drive Roof Fans  
Horizontal Outlet  
1800 m<sup>3</sup>/h  
120°C



**BRF-V**  
Centrifugai Roof Fans  
Vertical Outlet  
850 - 9600 m<sup>3</sup>/h



**BRDV**  
Direct Drive Roof Fans  
Vertical Outlet  
1700 - 10500 m<sup>3</sup>/h  
120°C



**BACF**  
Axial Roof Fans  
Horizontal Outlet  
1800 - 42000 m<sup>3</sup>/h

AXIAL FANS



**BK**  
Axial Fans/ Lid Option  
450 - 1150 m<sup>3</sup>/h



**BB**  
Axial Fans  
450 - 1150 m<sup>3</sup>/h



**BDRAX**  
Axial Fans  
400 - 3110 m<sup>3</sup>/h



**BORAX**  
Axial In Line Duct Fan  
680-3110 m<sup>3</sup>/h



**4M-4T**  
Cooling Fans / Single-Three Phase  
1000 - 6900 m<sup>3</sup>/h



**B5P-B6P**  
Plastic Axial Blades  
Adjustable Angles

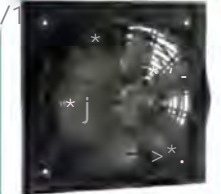

**B6PA**  
Wall Mounted Axial Fans  
Plastic Blade  
1500 - 7200 m<sup>3</sup>/h



**B5PA**  
Wall Mounted Axial Fans  
Plastic Blade  
8500 - 37000 m<sup>3</sup>/h

# INDEX



**BSM-BST**  
Industrial Axial Fans  
1200 - 8000 m<sup>3</sup>/h

1L3



**BSMS-BSTS**  
Wall Mounted Axial Fans  
1200 - 8000 m<sup>3</sup>/h

lc 13



**BTF**  
Tube Fans  
4000 - 51000 m<sup>3</sup>/h

1L34

## RADIAL FANS



**BASSF**  
Centrifugal Motorized Impellers  
Forward Curved  
275 - 6000 m<sup>3</sup>/h

14



**BDRAS**  
Centrifugal Blowers  
Aluminum Body  
80 - 600 m<sup>3</sup>/h

d.44



**BDRS**  
Centrifugal Blowers  
Sheet Metal Body  
250 - 600 m<sup>3</sup>/h

11j



**BPS 140-60**  
Centrifugal Blowers  
Plastic Housing  
500 m<sup>3</sup>/h

d.50Q



**BPS-B 140-60**  
Centrifugal Blower / Plastic Body  
500 m<sup>3</sup>/h

12



**BPS-B 150-100**  
Double Inlet Centrifugal Blower  
Plastic Housing  
720 m<sup>3</sup>/h

12



**AORB**  
Direct Drive Centrifugal Blower  
Metal Body  
1200 m<sup>3</sup>/h

15



**OBR 140**  
Centrifugal Fans / Single inlet  
1100 m<sup>3</sup>/h

154



**OBR 200**  
Centrifugal Fans / Single inlet  
850 - 1800 m<sup>3</sup>/h

156



**OBR 260**  
Centrifugal Fans / Single inlet  
1450 - 2700 m<sup>3</sup>/h

158



**IMS / ITS**  
Centrifugal Fans / Single inlet  
1500 m<sup>3</sup>/h



**BDS**  
Centrifugal Blowers  
Aluminum Housing  
800 - 8400 m<sup>3</sup>/h



**BFC**  
Fancoil Fans  
Forward Curved  
800 m<sup>3</sup>/h



**QES**  
Centrifugal Blowers  
Double inlet  
1300 m<sup>3</sup>/h



**OOES**  
Centrifugal Blowers  
Double inlet  
2200 m<sup>3</sup>/h



**BRV / BRV-K**  
Low Pressure Centrifugal Fans  
Forward Curved  
3500 - 25000 m<sup>3</sup>/h



**BRV-D**  
Direct Drive Double Inlet Centrifugal Fan  
1500 - 6000 m<sup>3</sup>/h



**BRV-S**  
Low Pressure Centrifugal Fans  
Single inlet  
5000 - 20000 m<sup>3</sup>/h



**BSK**  
High Pressure Centrifugal Fans  
Backward Curved - Welded  
3000 - 32000 m<sup>3</sup>/h



**BPF**  
Plug Fans  
Backward Curved  
800-9000 m<sup>3</sup>/h



**ALQ**  
Low Pressure Centrifugal Fans  
1500 - 10000 m<sup>3</sup>/h



**BGSS**  
Low Pressure Centrifugal Fans  
Backward Curved - Large Blade  
3500 - 40000 m<sup>3</sup>/h



**BORKA**  
Medium Pressure Centrifugal Fans  
Backward Curved  
900 - 4300 m<sup>3</sup>/h



**ORB**  
Medium Pressure Centrifugal Fans  
950-4000 m<sup>3</sup>/h



**YB**  
High Pressure Centrifugal Fans  
350 - 1500 m<sup>3</sup>/h

# INDEX

## PLASTIC FANS



EF  
Plastic Domestic Fans  
Decorative  
90 - 300 m<sup>3</sup>/h

22 j0



EA  
Plastic Domestic Fans  
Standard  
100 - 300 m<sup>3</sup>/h

22 j2

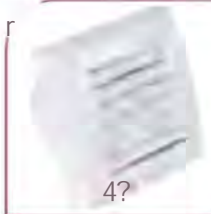

EC  
Plastic Domestic Fans  
Automatic Shutter  
100 - 300 m<sup>3</sup>/h

21 jf



BPP  
Reversible Wall Mounted  
Plastic Fans  
270-1080 m<sup>3</sup>/h

22!B

## VENTILATORS



BSV/ BSV-D  
Industrial Ventilators  
7000 -17400 m<sup>3</sup>/h

23!E

## SMOKE EXHAUST SYSTEMS



ARMO-J  
Axial Jet Fans  
0,75-3,02 m<sup>3</sup>/s

2



ARMO-A  
Axial Smoke Exhaust Fans  
1000 -155000 m<sup>3</sup>/h

23 j





## ACCESSORIES



**BSC**  
Speed Control Devices  
0.2 - 5 Amper

26.



**BSC-F**  
Frequency Invertors  
0.75-22 Kw

26. 0



**BYH**  
Circular Air Regulators  
0160 - 0400

26 jli



**BASP**  
Round Metal Shutters  
0160 - 0800

26 j 1



**BDH**  
Rectangular Air Regulators  
100/200 - 2000/2000

26 j 2



**BDEB**  
Rectangular Flexible Flanges  
300/150 - 1000/500

26. 2



**BDKS**  
Rectangular Duct Type Silencers  
300/150 - 1000/500

26 j\*



**BYKS**  
Circular Duct Type Silencers  
0100 - 0355

26 j 3



**BYF**  
In-Line Duct Filters  
0200 - 0315

26 j 3



**BYEB**  
Circular Flexible Flanges  
0250 - 01000

26 J 4

# DUCT FANS

BDRKF

BDTX

BMFX

BPX

BFTX

BDKF

BDKF-R

BKKF

BSKF

BSKF-R

BKEF

BKEF-T

BKEF-R

BHV

BHV-R

# DUCT FANS



# BDRKF

AC      CENTRIFUGAL      MOTORIZED      IMPELLERS  
Backward Curved

Strong air suction / high pressure / high efficiency / powerful design / low noise / laminar air flow

## Technical Drawings

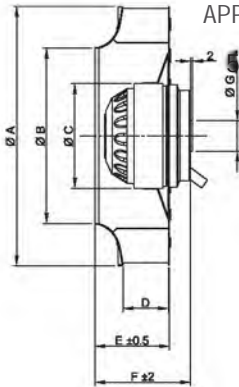
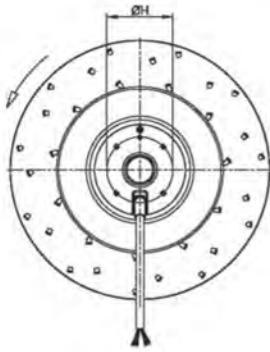

### MATERIAL

: Impeller is made of galvanized sheet metal or aluminium sheet.

### INSULATION CLASS DIRECTIVE

: Class & Class F

### SPEED CONTROL

: EN 60335, EN 60335-2-80

### APPLICATION AREAS

: Speed can be adjusted using an optional controller.

: For industrial applications, duct fans, roof fans, centrifugal fans, heat exchangers, Air Handling Units, in factories, hospitals, laboratories, offices, kitchens, etc.

TYPE	A			D	E	F	G	H	J
BDRKF160	162	121,5	92	40	60	74	27	58	M4
BDRKF180	180	121,5	92	40	60	84,5	27	58	M4
BDRKF 225	227	153	92	50	76	102	27	58	M4
BDRKF 250	252	172,5	92	50	79	102	27	58	M4
BDRKF 280	281	190	92	50	85	120,5	27	58	M4

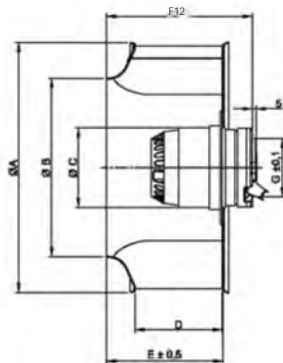
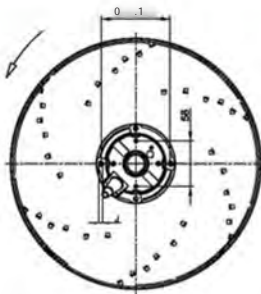

TYPE	A			D	E	F	G	H	J
BDRKF315	316	209	102	102	141	168	74	90	M6
BDRKF 355	356	243	102	102	113	172	74	90	M6

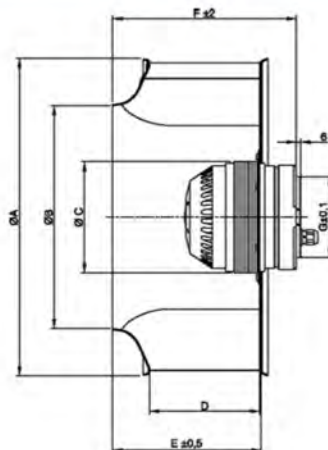
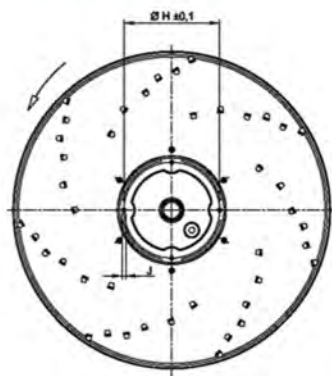

TYPE	A			D	E	F	G	H	J
BDRKF400	404	284	137,5	112	160	201	100	115	M6
BDRKF450	455	295	137,5	125	177	217	100	115	M6

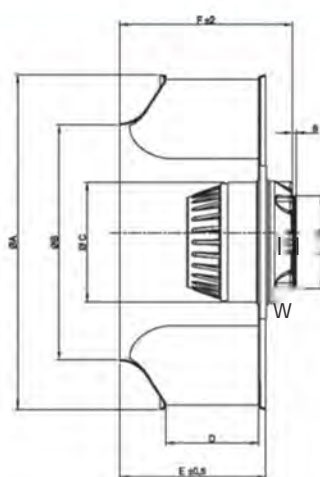
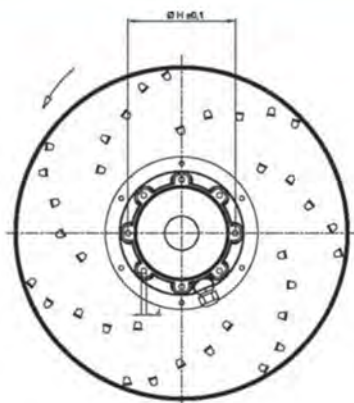

TYPE	A			D	E	F	G	H	J
BDRKF500	505	354	177,5	140	220	260	140	162	M10
BDRKF560	565	395	177,5	160	242	280	140	162	M10

TYPE	$\frac{E}{V}$	$\frac{E}{Hz}$	Op CL W	$\frac{Z}{(A)}$	$\frac{S}{(MF)}$	q/ d/d	$\frac{fit}{i \dots V+}$ $\frac{OPz}{V}$	$\frac{m^3/h}{dB(A)}$	$\frac{1^*}{}$
BDRKF160	230	50	75	0,33	2,5	2570	346	55	1,4
BDRKF180	230	50	85	0,4	2,5	2410	360	58	1,6
BDRKF225	230	50	105	0,48	4	2650	902	65	2,3
BDRKF250	230	50	125	0,55	5	2710	1124	68	2,8
BDRKF280	230	50	195	0,85	7	2620	1254	68	3,3
BDRKF315	230	50	120	0,6	4	1400	2061	55	5,8
BDRKF355	230	50	190	1,01	6	1400	2500	58	6,5
BDRKF400	230	50	350	1,6	12	1400	4000	68	10,4
BDRKF450	230	50	490	2,1	18	1412	4750	70	12
BDRKF 500	380	50	940	2,4	-	1420	8200	70	17
BDRKF560 380		50	1500	2,7	-	1350	11000	75	22

DUCT FANS

pass / ^ ^

ALL NUN

Z</>  
S</>  
CO ^  
CC

Z</>  
S</>  
3V

(  
VILOR

VILOR  
/ )  
22  
VILOR / J

CC

# DUCT FANS

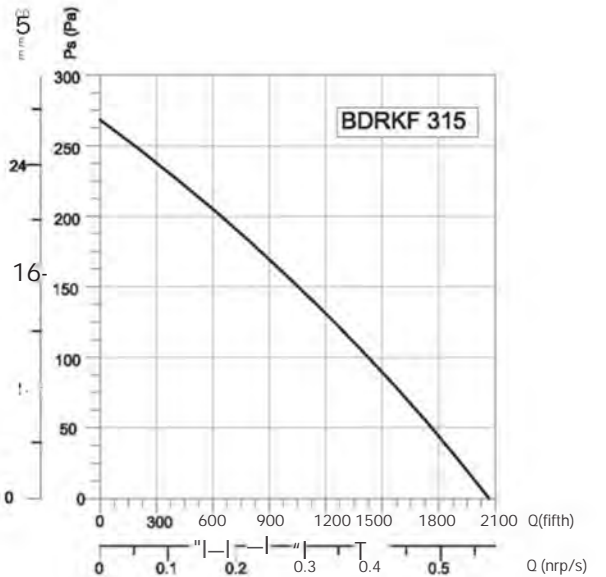
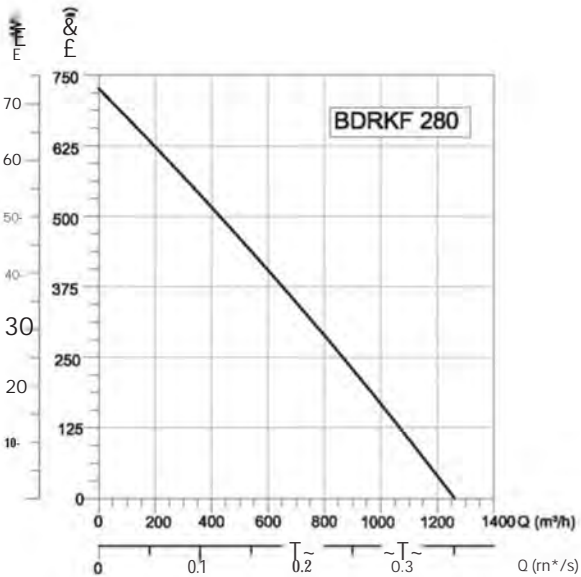
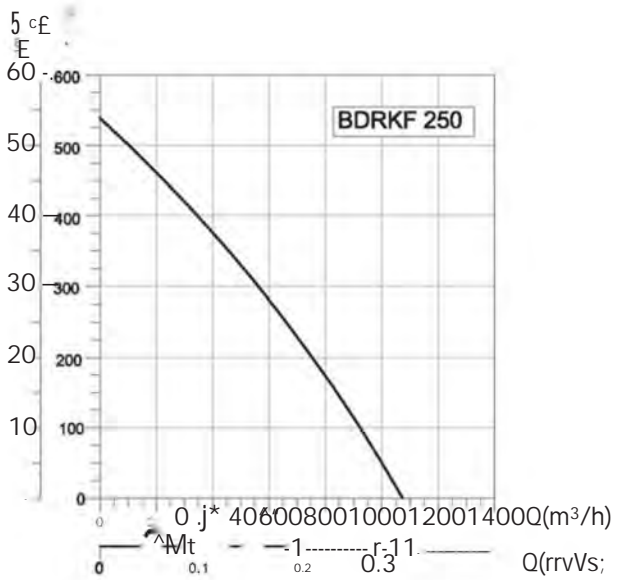
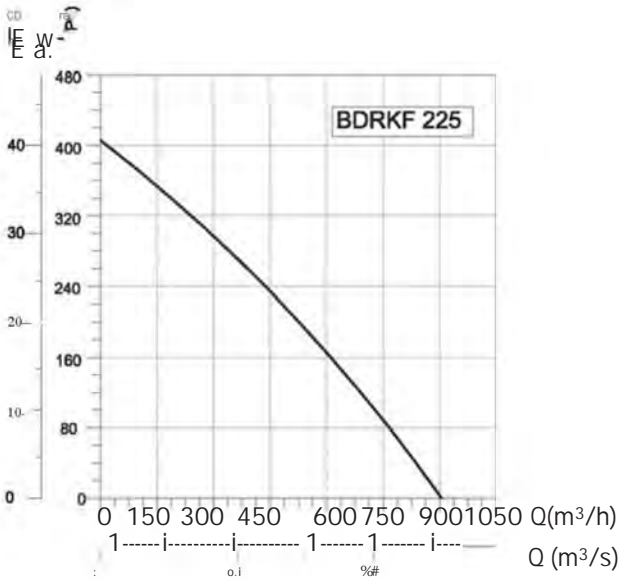
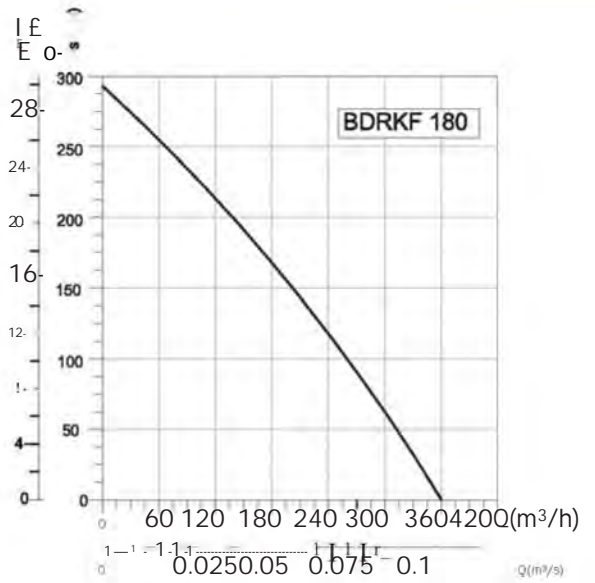
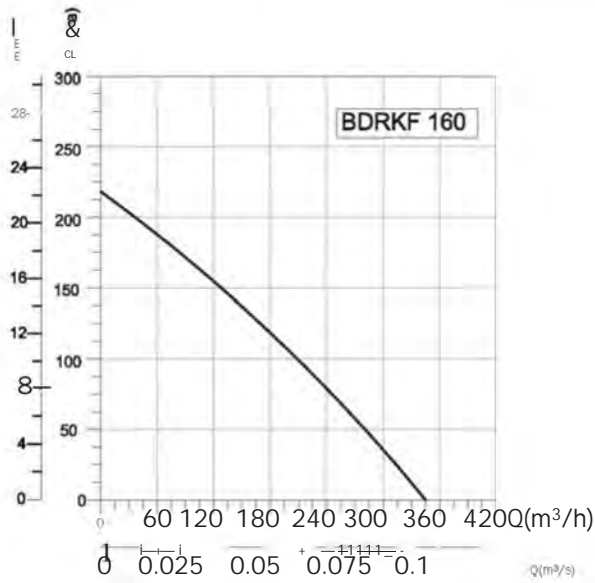

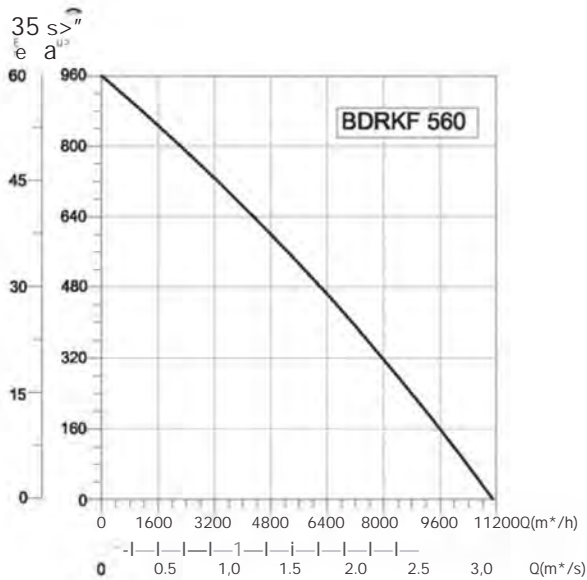
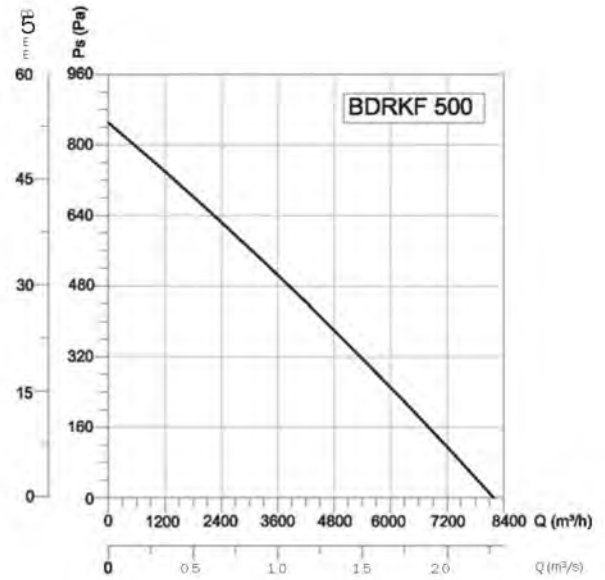
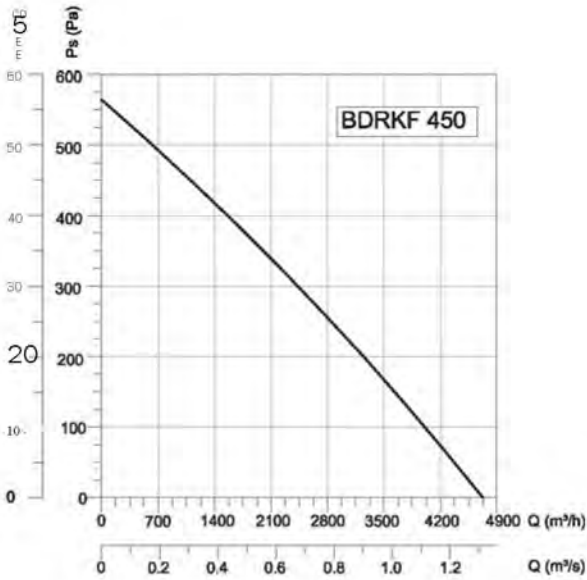
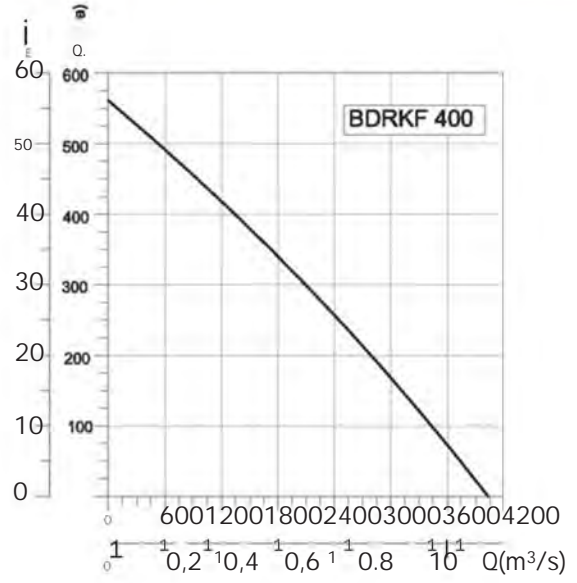
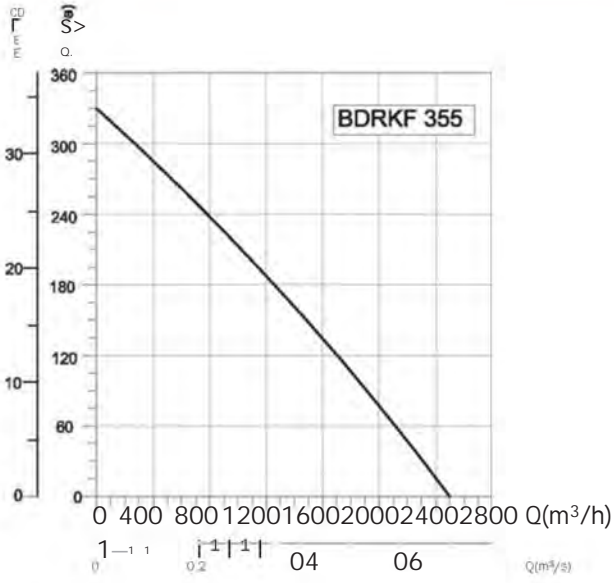

Accessories



**BSC**      **BSC-F**

DUCT FANS

(A)

Ventilator

SLIDE

Slider

Ventilator &

IS \$4  
U  
i:

CC

# DUCT FANS



## BDTX

### AC CENTRIFUGAL IN LINE DUCT FANS Backward Curved

Straight airflow and easy installation - with the high pressure stability, low noise level and high efficiency. Both sides of the BDTX fans is suitable to fit into the centrifugal duct and can be fixed with fastening clamps. Fans can be performed in any mounting position.

#### Technical Drawings

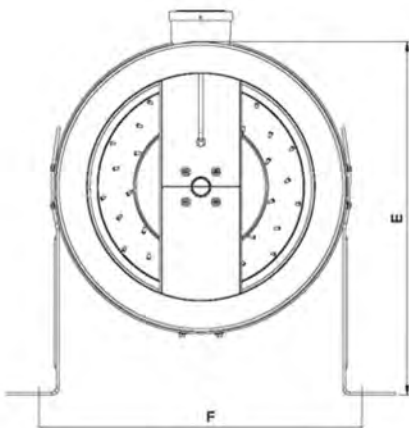
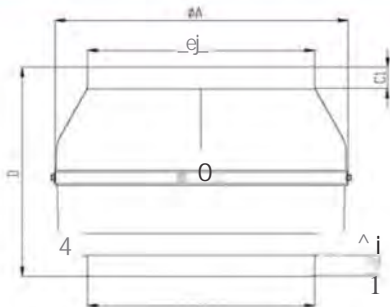

- MATERIAL** : The housing is made of electrostatic powder coated sheet iron, impeller is made of galvanized sheet metal. Housing forming is proceeded by stamps for proper fit.
- INSULATION CLASS** : Class B, Class F
- DIRECTIVE** : EN 60335-1, EN 60335-2-80
- PROTECTION OF MOTOR:** Thermal overload protection is available upon request. (Connector box- IP 55)
- SPEED CONTROL** : Speed can be adjusted using an optional controller.
- APPLICATION AREAS** : For industrial and constructional applications, in factories, hospitals, nightclubs, offices, kitchens, bathrooms, theaters, condominiums, restaurants, etc.



TYPE	A		Cl	⌀	D	E	F
BDTX 100	245	97	22	22	197	273	268
BDTX 125	245	122	20	20	188	273	268
BDTX 150B	272	147	23	25	192	286	295
BDTX 160A	272	157	23	25	192	286	295
BDTX 200A	330	196	30	28	230	380	352
BDTX 200B	330	196	30	28	230	380	352
BDTX 250A	330	247	30	28	227	380	352
BDTX 250B	330	247	30	28	227	380	352
BDTX315A	400	313	30	30	285	415	422
BDTX315B	400	313	30	30	285	415	422
BDTX 355	400	352	30	30	378	415	422

Dimensions are in (mm)

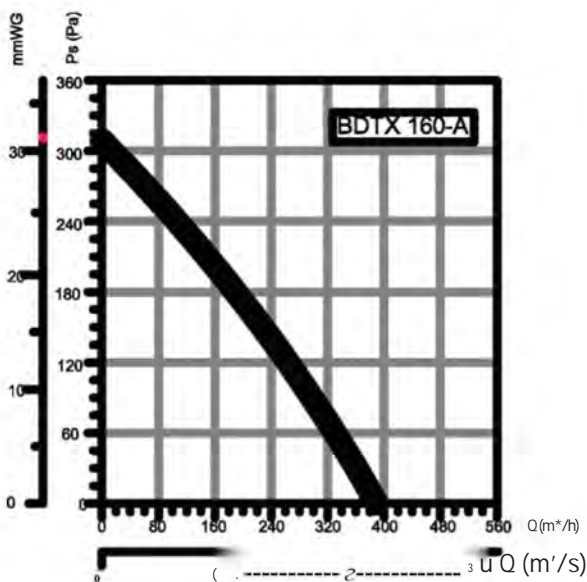
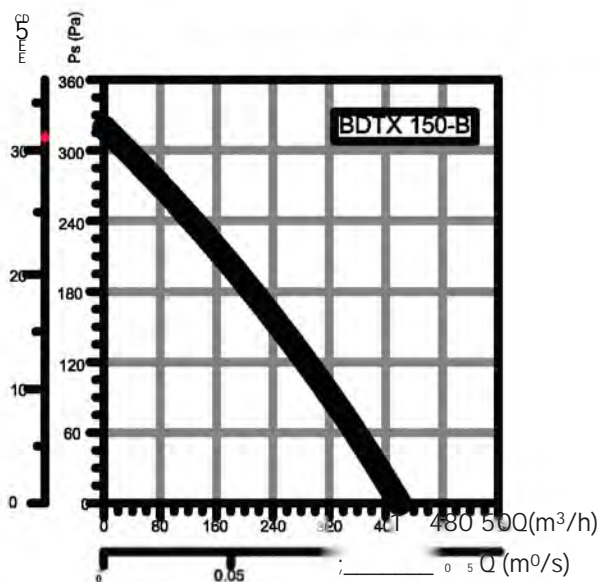
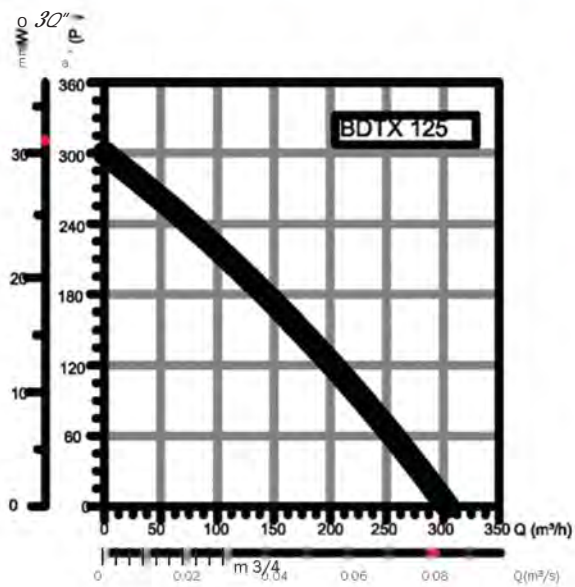
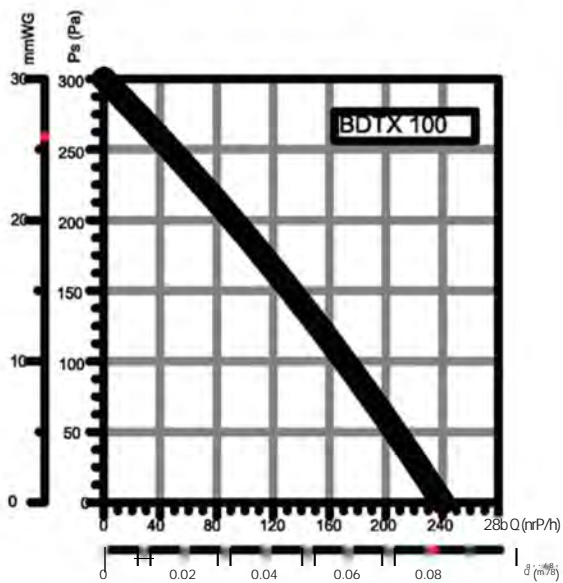

TYPE	VOLTAGE	FREQUENCY	POWER	CURRENT	CAPACITOR	SPEED	AIR FLOW	SOUND PRESSURE LEVEL	WEIGHT
	V	Hz	W (A)		(UF)	d/d	m³/h	dB(A)	kg
BDTX 100	230	50	80	0,3	2	2610	240	50	2,6
BDTX 125	230	50	80	0,36	2,5	2325	315	55	2,7
BDTX 150+B	230	50	85	0,38	2,5	2425	420	55	3,2
BDTX 160-A	230	50	90	0,4	2,5	2385	390	55	3
BDTX 200-A	230	50	95	0,43	2,5	2280	735	55	4,4
BDTX 200-B	230	50	122	0,55	4	2550	870	56	4,8
BDTX 250-A	230	50	124	0,56	4	2500	1010	57	4,9
BDTX 250-B	230	50	145	0,63	5	2635	1150	58	5,3
BDTX 315-A	230	50	190	0,9	5	2560	1450	65	6,8
BDTX 315-B	230	50	210	0,9	7	2660	1750	65	6,9
BDTX 355	230	50	123	0,63	4	1420	1300	66	9



# DUCT FANS

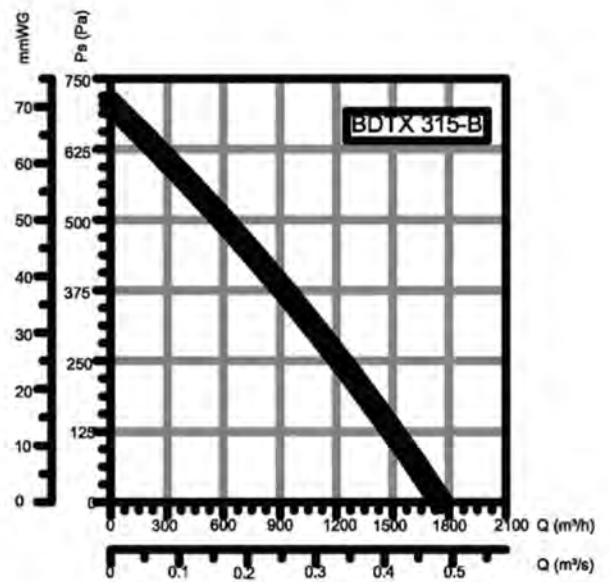
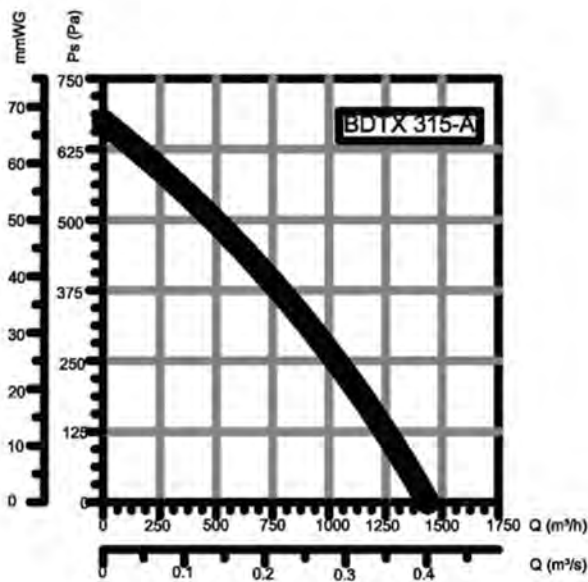
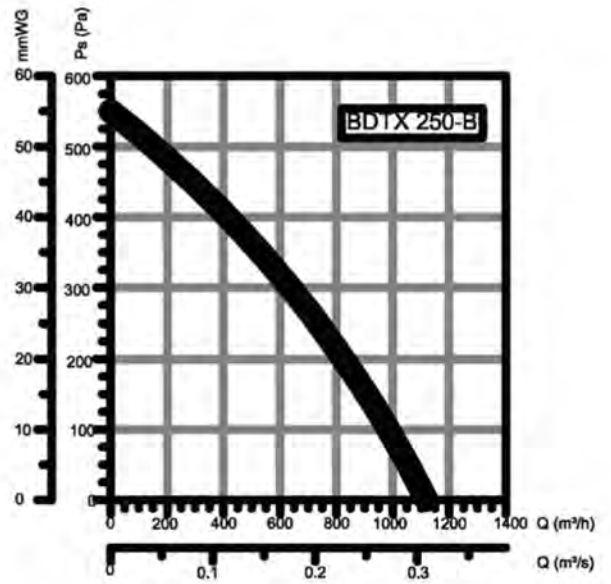
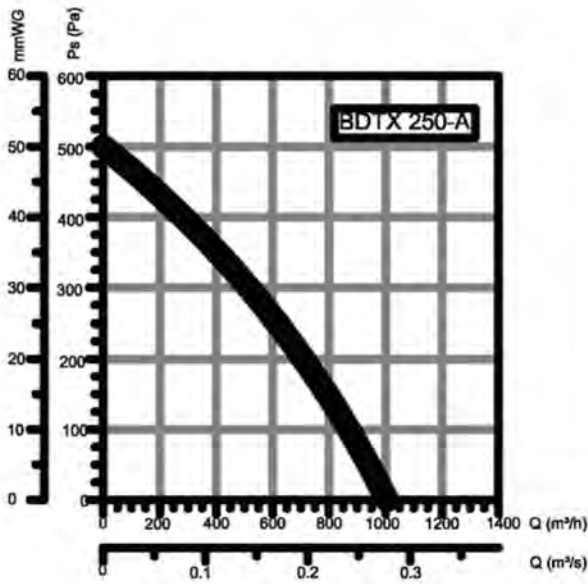
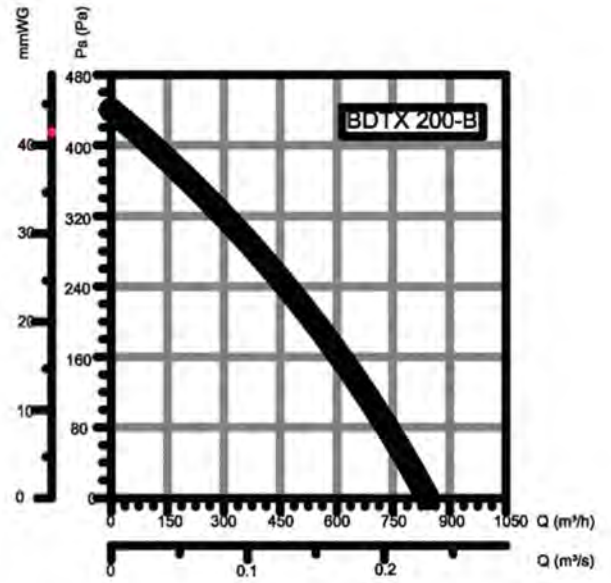
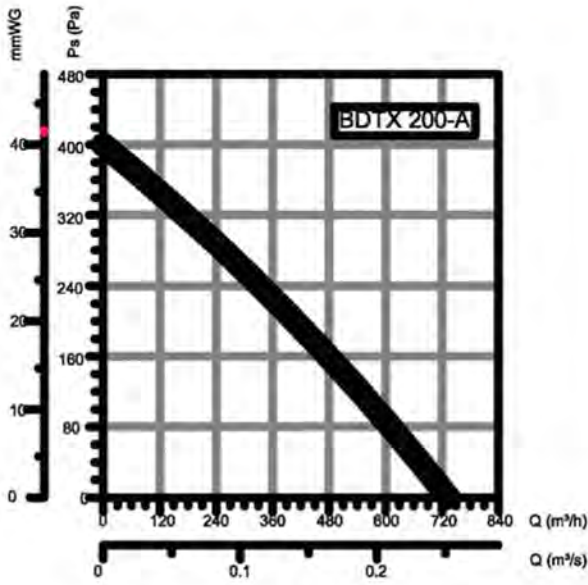

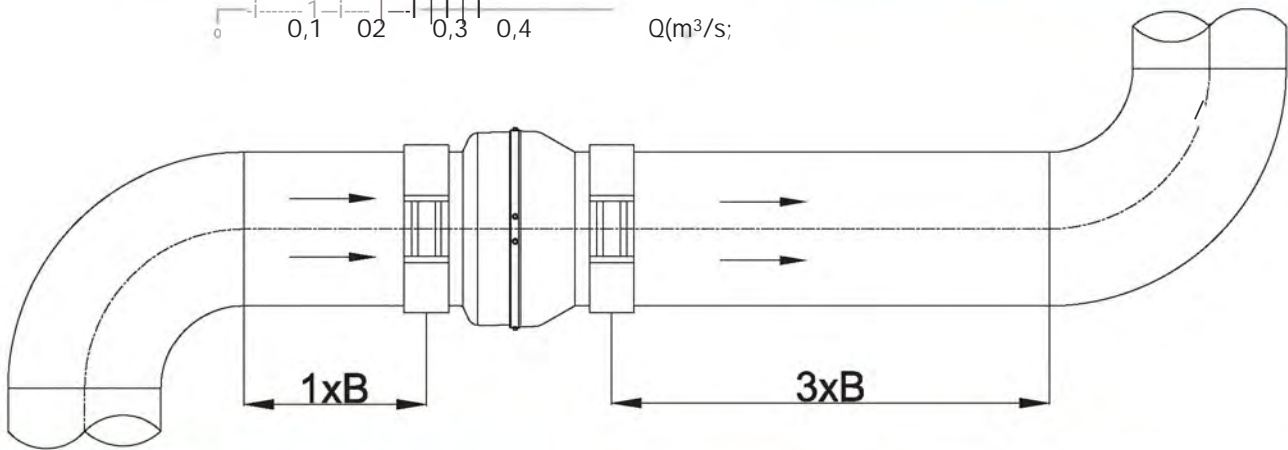
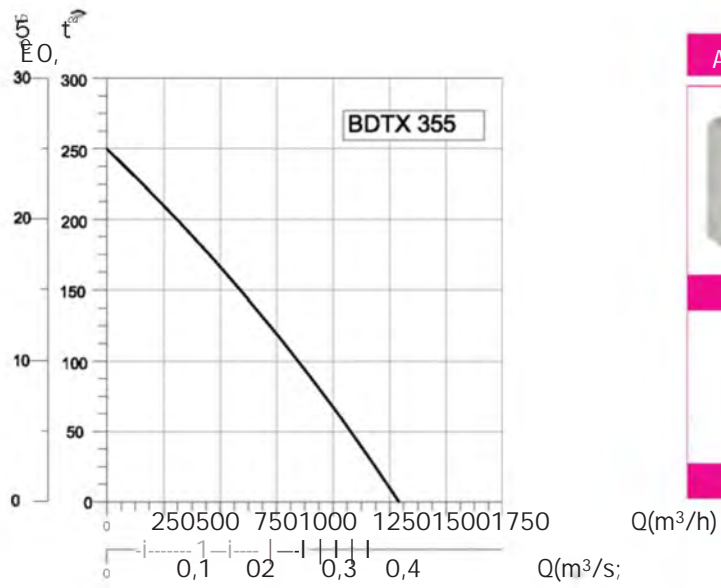

# DUCT FANS

# BMFX

## IN LINE DUCT FANS

### Mixed Flow



The low profile of the range makes them the most effective solution (for installations where space is restricted). Mixed flow duct fans are able to supply high air volume with low sound levels. The unique design of the support bracket allows the central cartridge, holding the motor and impeller assembly, to be fitted or removed without dismantling the ductwork.

### Technical Drawings

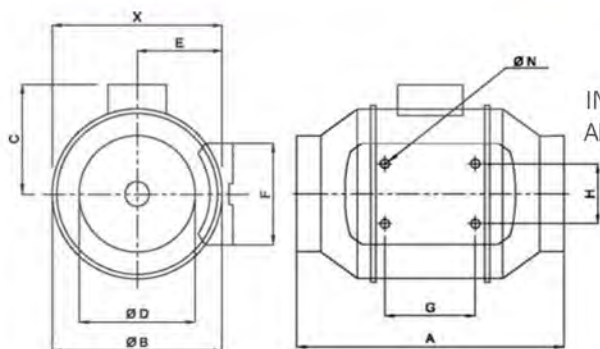

### MATERIAL

: Range of in-line mix flow duct fans are made of polypropylene plastic, one-time disposable molded, with high anti-acid function (from BMFX 100 to BMFX 200 models) or with metal casing steel finished with electrostatic powder paint (from BMFX 250 to BMFX 315 models).

: IP44 Protection Class

: Practical examples of installation of the BMFX mix flow fans range. The BMFX fans provide a large number of solutions for small and large ventilations. Residential-Kitchen, Domestic-Range Hood Exhaust, Commercial-Office, Industrial-Republic Restroom, School-Dining Hall, Industrial-Locker Room Health-Waiting Room, Meeting Room, Catering, Gym, Bathroom, Study Room.

### INSULATION CLASS APPLICATION AREAS

TYPE	X	A			D	E	F	G	H	N
BMFX 100	188	303	176	115	97	100	90	80	60	5,5
BMFX 125	188	258	176	115	123	100	90	80	60	5,5
BMFX 150	212	320	200	127	147	112	130	80	60	5,5
BMFX 200	232,5	302	217	141	197	124	140	100	94	5,5
BMFX 250	291	386	272	192	248	155	168	145	140	7X4
BMFX 315	356	450	336	224	312	188	210	182	178	7X4

Dimensions are in (mm)

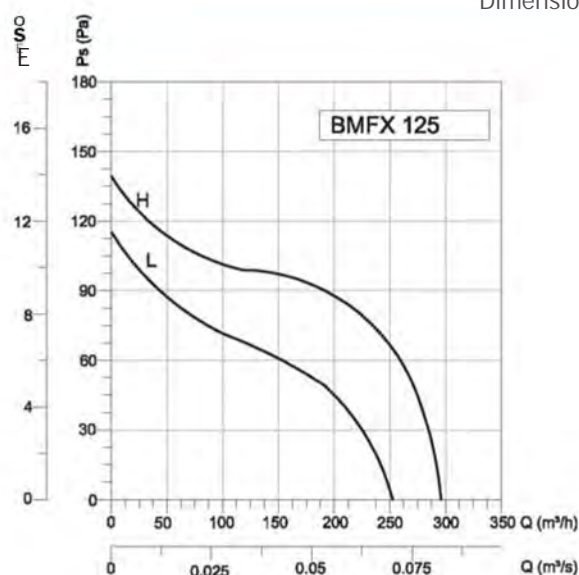
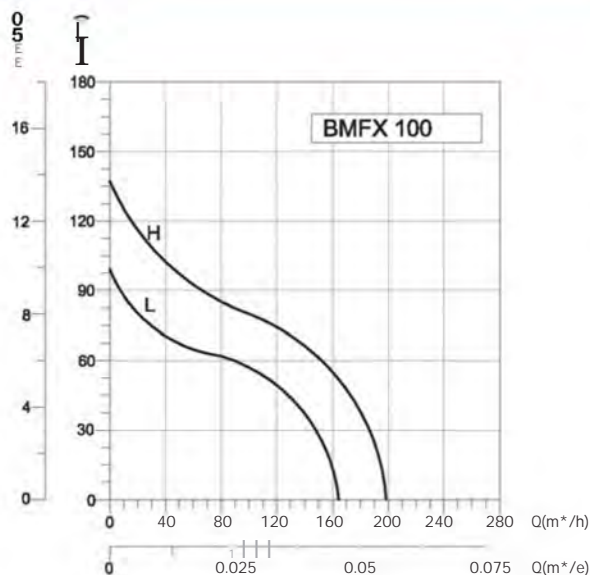

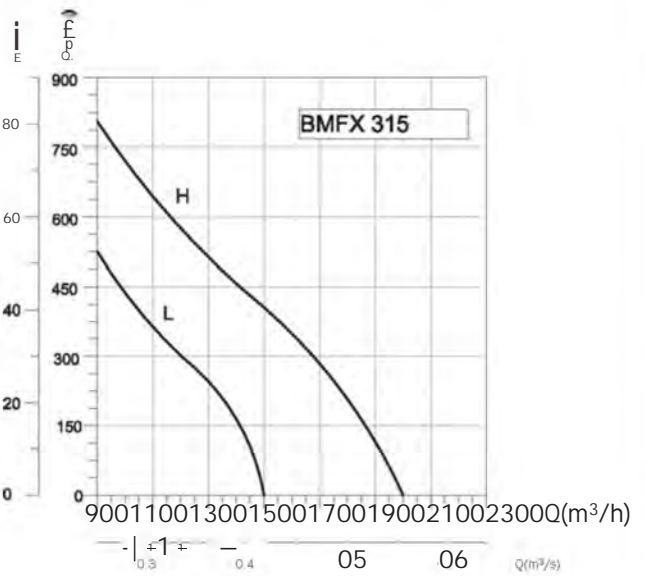
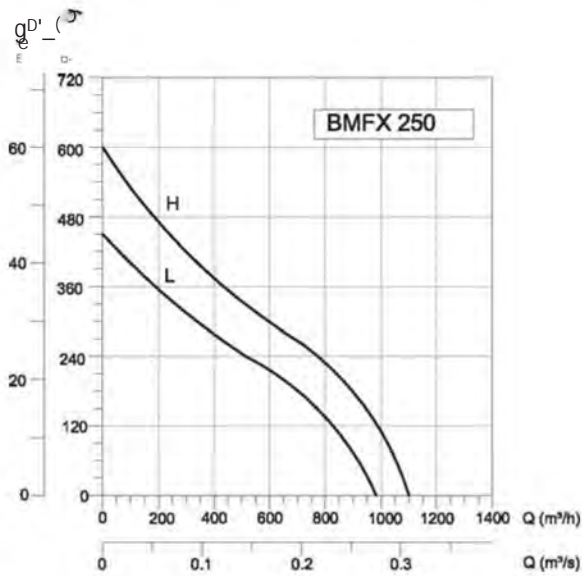
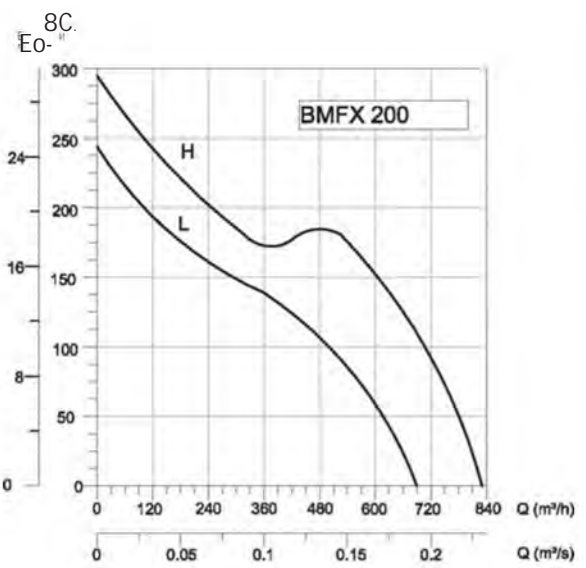
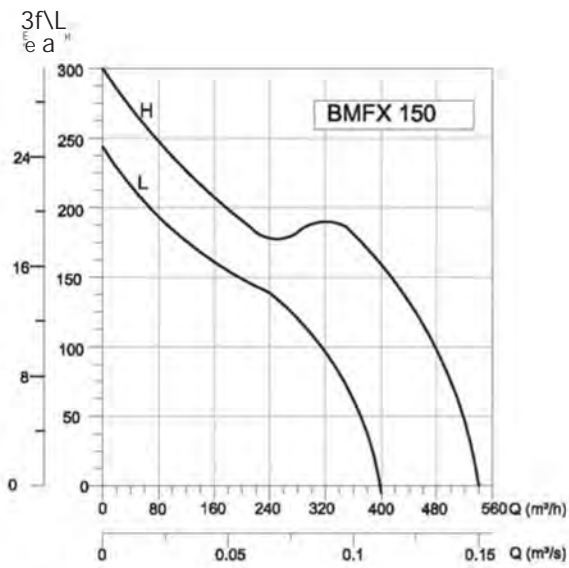

TYPE	V	Hz	W	(A)	(MF)	d/d	m³/h	dB(A)	kg
BMFX 100	230	50	26 23	0,12 0,11	1	2200 1850	198 165	31 26	2
BMFX 125	230	50	33 28	0,14 0,13	1	2250 1850	284 248	31 26	1,8
BMFX 150	230	50	54 48	0,24 0,21	1,5	2550 1850	530 410	33 29	2,7
BMFX 200	230	50	125 123	0,57 0,52	3	2450 1950	840 690	63 55	4,9
BMFX 250	230	50	170 125	0,5 0,45	8	2750 2400	1100 990	60 58	9,4
BMFX 315	230	50	200 140	0,9 0,64	10	2680 2150	2000 1500	70 65	14

# DUCT FANS

## BPX

AC IN LINE DUCT FAN

Plastic Housing



Straight airflow and easy installation - with the high pressure stability, low noise level and high efficiency of centrifugal fans, Both sides of the BPX fan should be fitted into the tube and can be fixed with fastening clamps, Fans can be performed in any mounting position,

### Technical Drawings

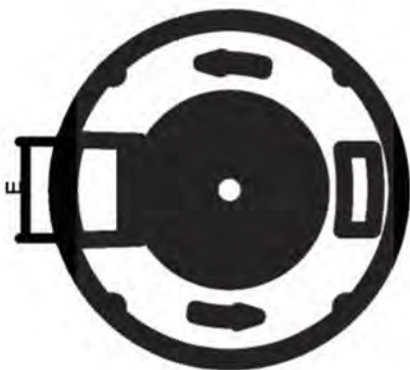
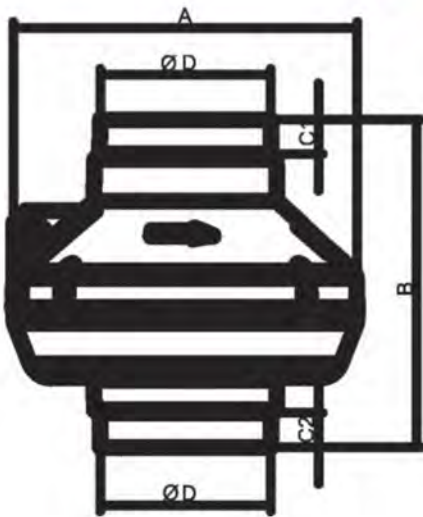

- MATERIAL** : The housing is made of plastic; Backward curved impeller is made of galvanized sheet metal, BPX is suitable for fitting both 150mm and 160mm duct diameter,
- INSULATION CLASS** : Class
- DIRECTIVE** : Complying with EN 60335-1, EN 60335-2-80
- SPEED CONTROL** : Speed can be adjusted using an optional controller.
- APPLICATION AREAS** : For industrial and constructional applications, in factories, hospitals, nightclubs, offices, kitchens, bathrooms, theaters, acidic environments, condominiums, restaurants, etc,

### Accessories



BSC



BYKS



BYH



BYE

TYPE	A		CI	C2	OD	E
BPX 150	302	287	30	30	149	85

Dimensions are in (mm)

TYPE	W b > V	Q L <sup>34</sup> Hz	CC F Q w	H b (A)	Q ≤ <K> (MF) d/d	E 3 DC m <sup>3</sup> /h	DC QIND CLASSU LEVEL 100-1 dB(A)	X o > kg	
BPX 150	230	50	85	0,38	2,5	2400	410	56	2,7

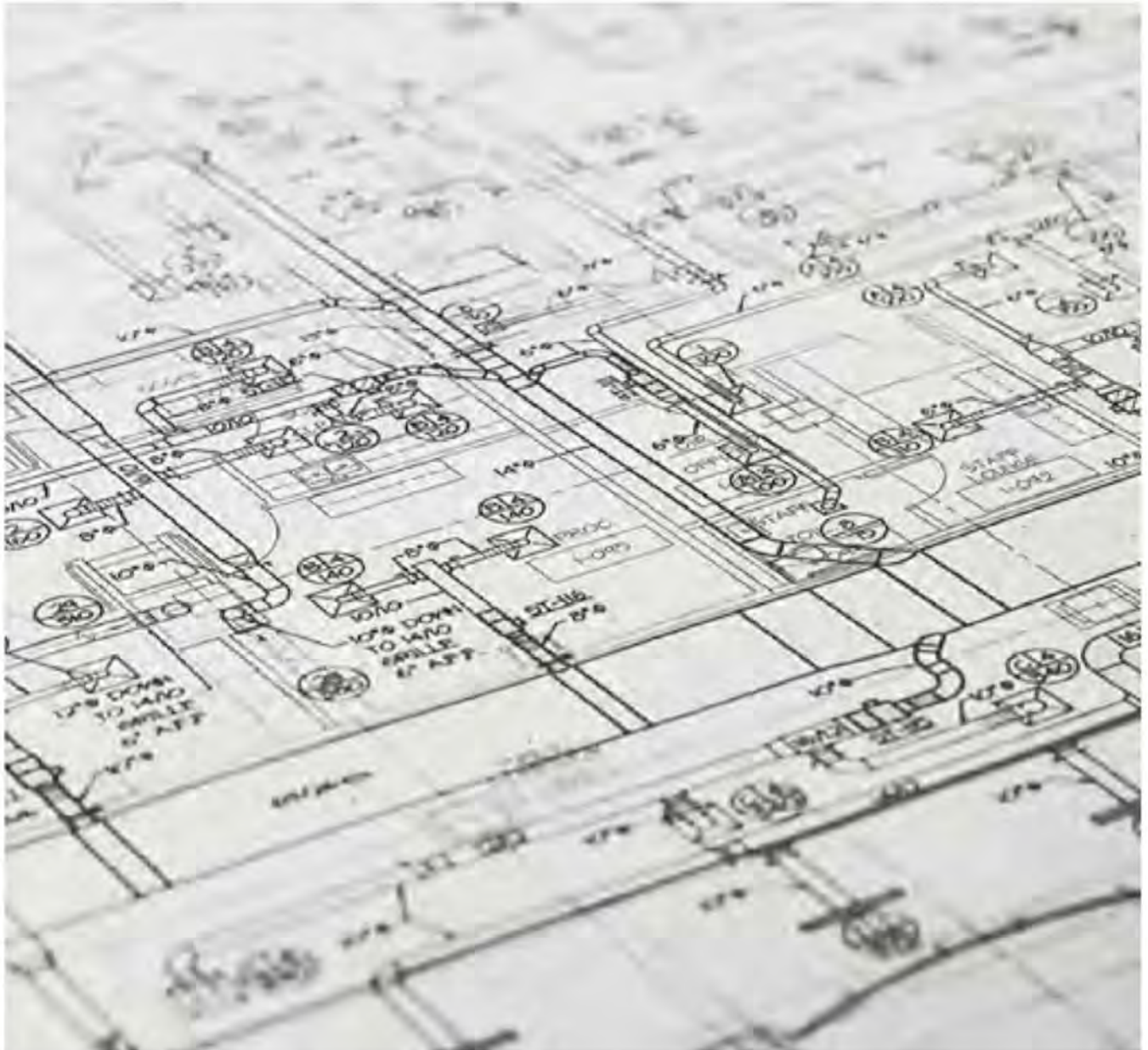
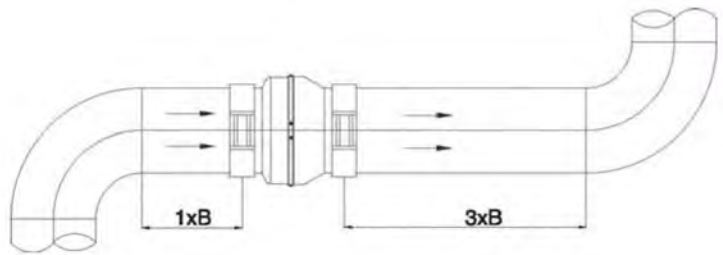
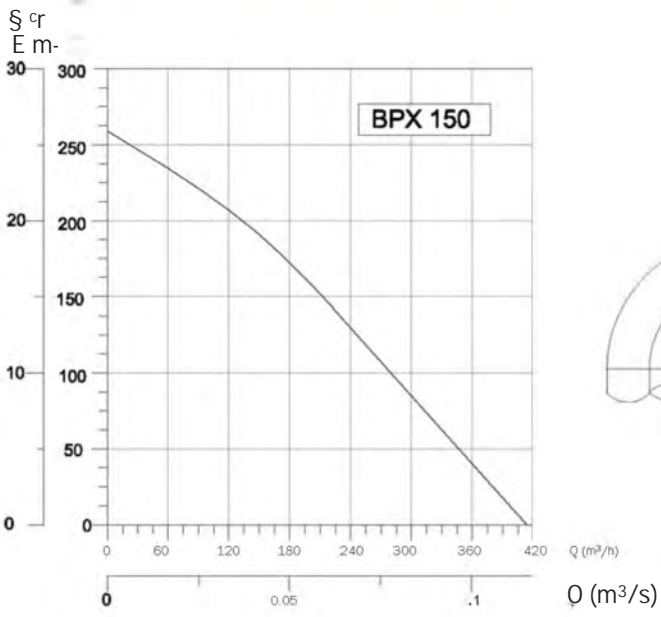

## DUCT FANS



# BFTX

## AC WALL MOUNTED DUCT FANS Backward Curved

Straight airflow and easy installation to the wall - high pressure stability, low noise level and high efficiency.

### Technical Drawings

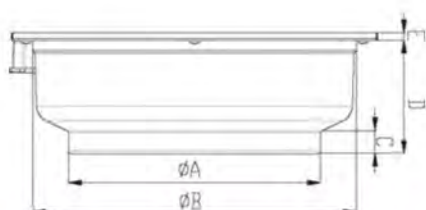
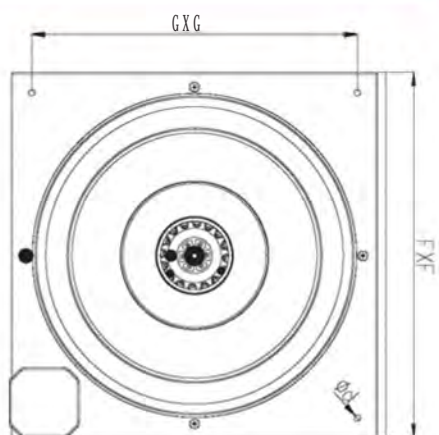

### Accessories



### BSC

- MATERIAL** : The housing is made of electrostatic powder coated sheet iron, backward curved galvanized impeller.
- INSULATION CLASS** : Class
- DIRECTIVE** : Complying with EN 60335-1, EN 60335-2-80
- SPEED CONTROL** : Speed can be adjusted using an optional controller.
- APPLICATION AREAS** : For industrial and constructional applications, in factories, hospitals, nightclubs, offices, kitchens, bathrooms, theaters, condominiums, restaurants, etc.

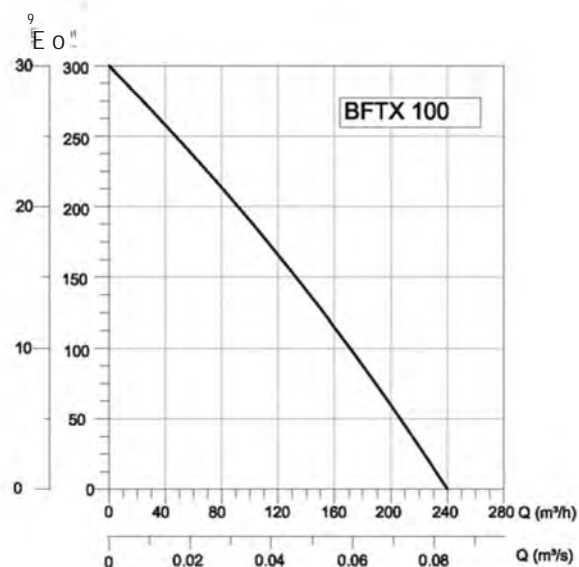

TYPE	OA			D	E	F	G	d
BFTX 100	97	244	20	100	9	315	265	8
BFTX 150	147	270	24	105	9	400	350	8
BFTX 200	196	330	24	113	9	400	350	8
BFTX 250	246	330	24	116	9	400	350	8
BFTX 315	310	398	26	140	9	500	400	8

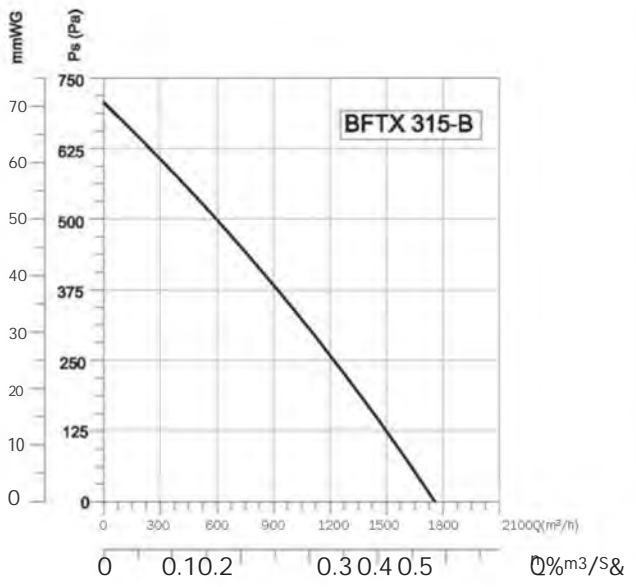
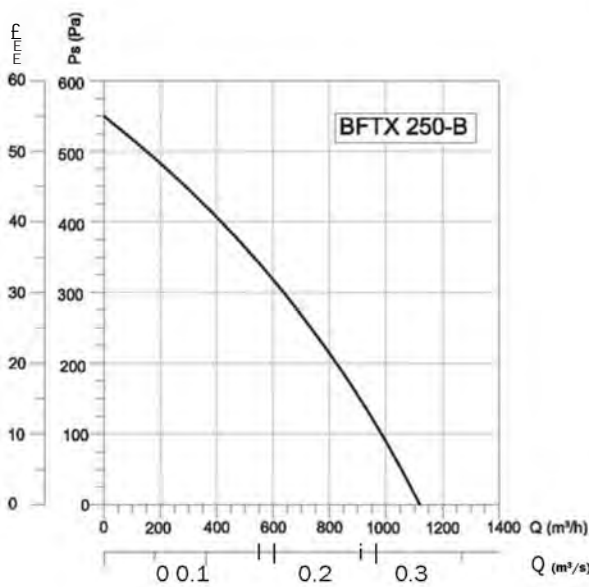
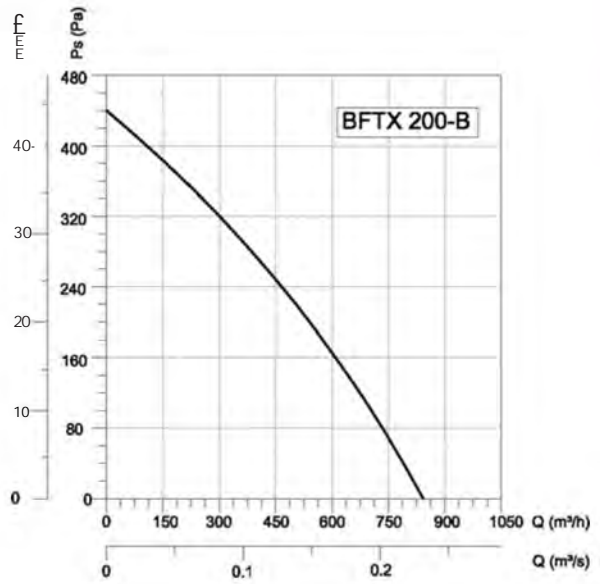
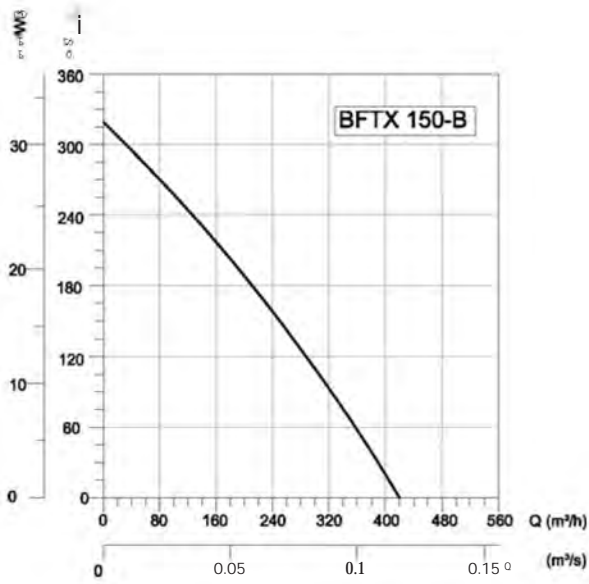

TYPE	LU V	f <sub>LU</sub> Hz	or 1 w	1/2 EE OE (A)	b sg 0 (MF)	0 ( d/d	s T°1 ar < m³/h	or ijjld <sub>w</sub> <000- dB(A)	1- 0 s kg
BFTX 100	230	50	70	0,3	2	2540	240	50	2.7
BFTX 150-B	230	50	85	0,38	2.5	2430	420	55	3.6
BFTX 200-B	230	50	115	0,5	4	2600	870	56	4.8
BFTX 250-B	230	50	135	0,59	5	2620	1150	57	5.3
BFTX 315-B	230	50	180	0,76	7	2650	1750	65	6.6



## DUCT FANS

# BDKF

## AC RECTANGULAR IN LINE DUCT FANS Backward Curved



Bahçivan Brand Rectangular In-Line Duct Fans engineered for medium and large ventilation needs where space is at a premium. BDKF Rectangular fans developed and manufactured for high performance, trouble-free, and direct-to-duct operations. The motorized impeller is mounted on a hinged door - the user just swings the door out for easy access to the impeller for maintenance.

### Technical Drawings

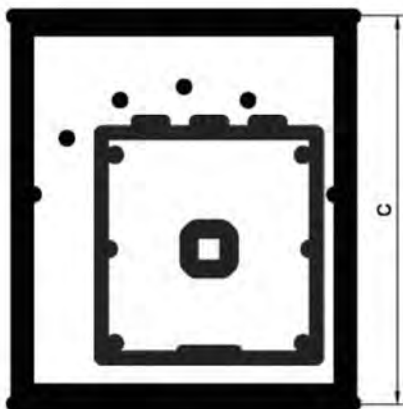
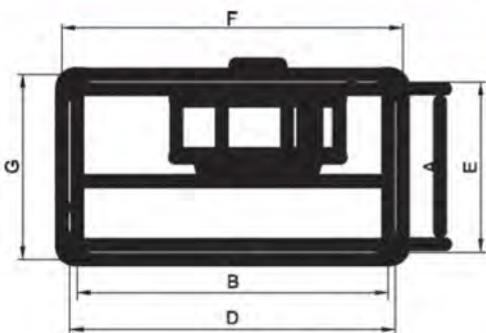

- MATERIAL** : The housing and impeller is galvanized sheet steel.
- INSULATION CLASS** : Class
- DIRECTIVE** : Complying with EN 60335-1, EN 60335-2-80
- PROTECTION OF MOTOR** : Thermal overload protection is available upon request.(Connector box- IP 55)
- SPEED CONTROL** : Speed can be adjusted using an optional controller.
- DIRECTION OF ROTATION** : Direction of impeller from inlet side is CW (Clock wise). As it is going to cause extra load on the wrong direction rotation must be checked carefully.
- APPLICATION AREAS** :
  - BDKF rectangular in-line duct fan series is perfect for use in residential, commercial, and industrial environments, for ventilation applications such as:
  - Residential; Bathrooms, toilets, utility rooms, indoor swimming pools, gyms, and storerooms.
  - Commercial; Cafes, bars, restaurants, shops, schools, offices, factories, buildings, warehouses, nightclubs, pubs, hotels, shopping centers, and leisure centers.
  - Industrial; Equipment cooling, workshops, and spot ventilation.

TYPE	A	B	C	D	E	F	G
BDKF 30-15	150	300	400	320	170	350	200
BDKF 40-20A	200	400	500	420	220	450	250
BDKF 40-20B	200	400	500	420	220	450	250
BDKF 50-25	250	500	565	520	270	550	300
BDKF 60-30	300	600	650	620	320	650	350
BDKF 60-35A	350	600	760	620	370	650	400
BDKF60-35B	350	600	760	620	370	650	400
BDKF70-40A	400	700	800	720	420	750	450
BDKF70-40B	400	700	800	720	420	750	450
BDKF 80-50	500	800	920	820	520	850	560
BDKF 100-50	500	1000	1050	1030	530	1060	560

Dimensions are in (mm)

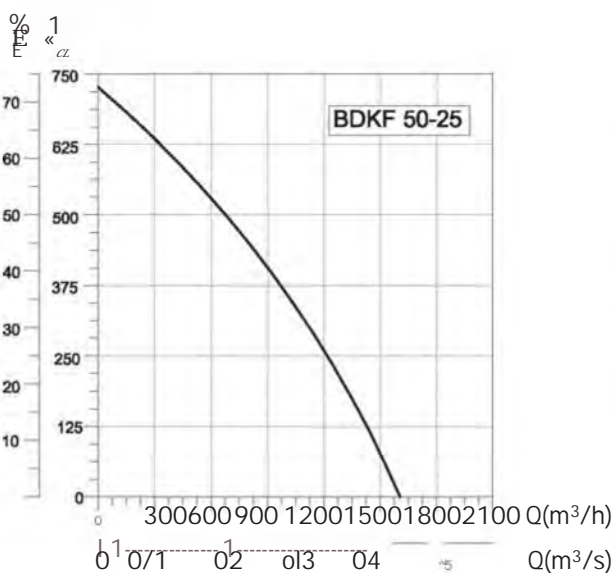
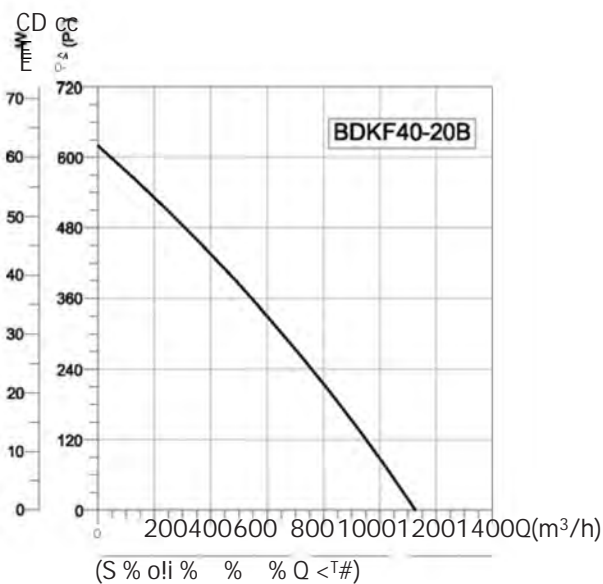
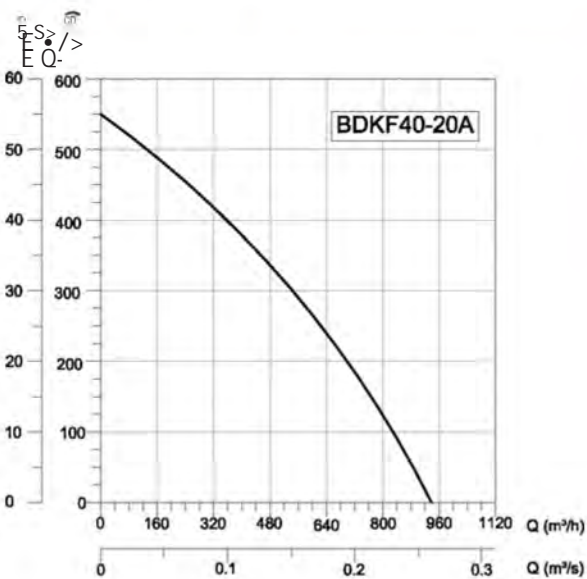
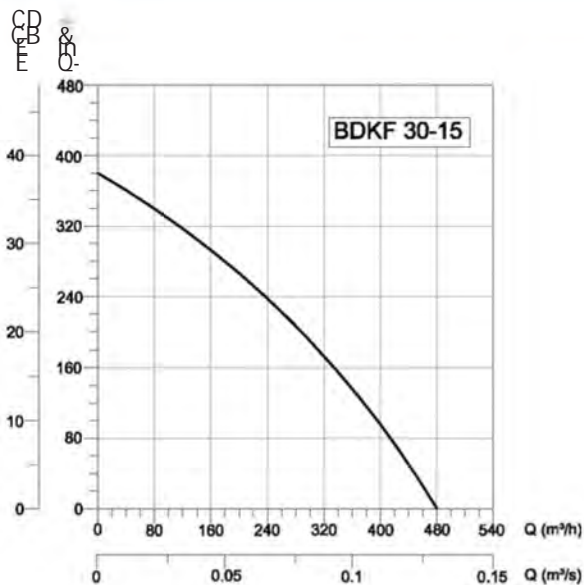

	1 S V	2 Q Hz	3 Q w	4 CE (A)	5 P (MF)	6 a </> d/d	7 CE m/h	8 w dB(A)	9 x S kg
BDKF 30-15	230	50	90	0,4	2,5	2630	480	70	7
BDKF 40-20A	230	50	104	0,47	4	2645	950	73	10,5
BDKF 40-20B	230	50	130	0,58	5	2675	1150	75	11
BDKF 50-25	230	50	180	0,8	6	2635	1610	78	15
BDKF 6030	230	50	147	0,66	6	1440	1850	70	29
BDKF 6035A	230	50	340	0,64	6	1440	2800	72	31
BDKF60-35B	230	50	380	0,96	8	1420	3400	78	32
BDKF70-40A	230	50	620	2,06	16	1430	4500	78	44
BDKF 70-40B	230	50	690	3	18	1435	5900	79	46
BDKF 80-50	380	50	1080	2,5	-	1350	7550	79	66
BDKF 100-50	380	50	1670	3	-	1350	9600	80	84

# DUCT FANS

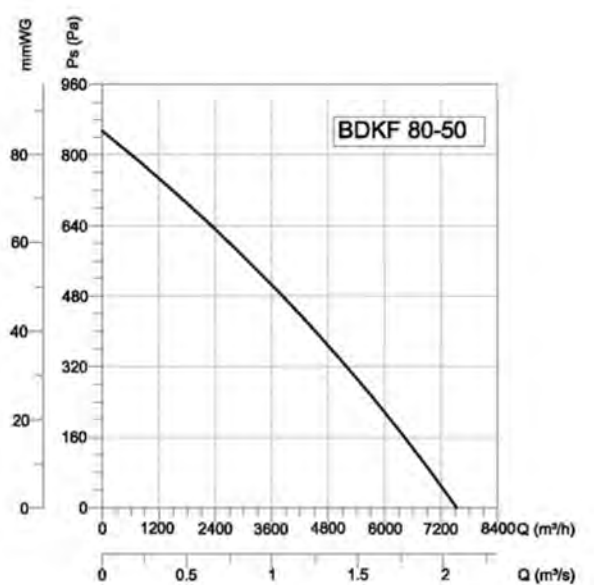
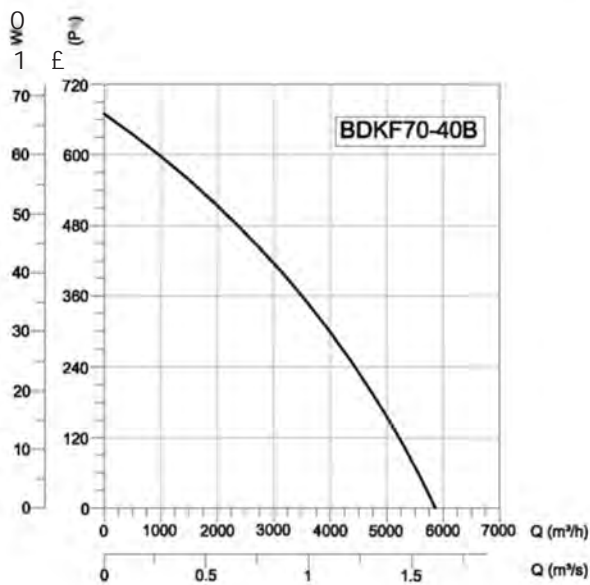
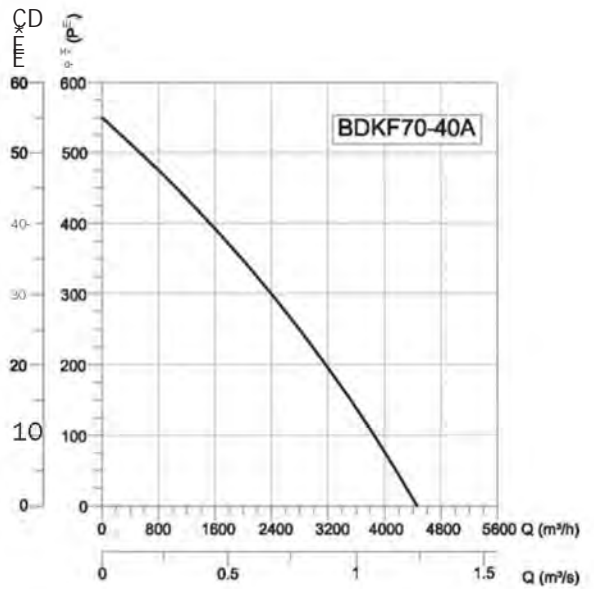
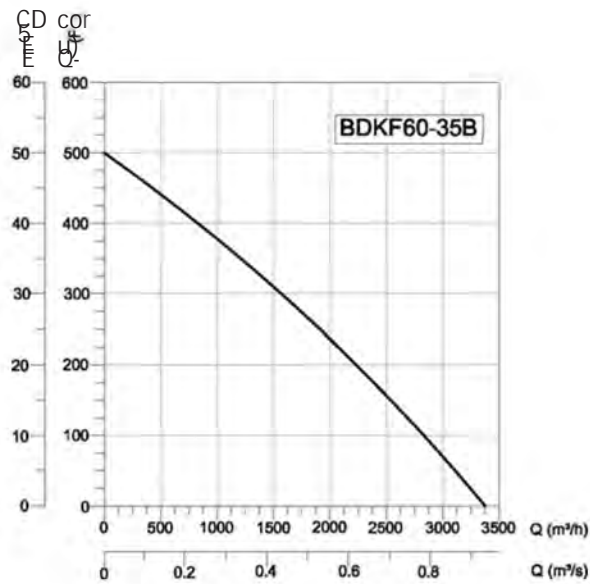
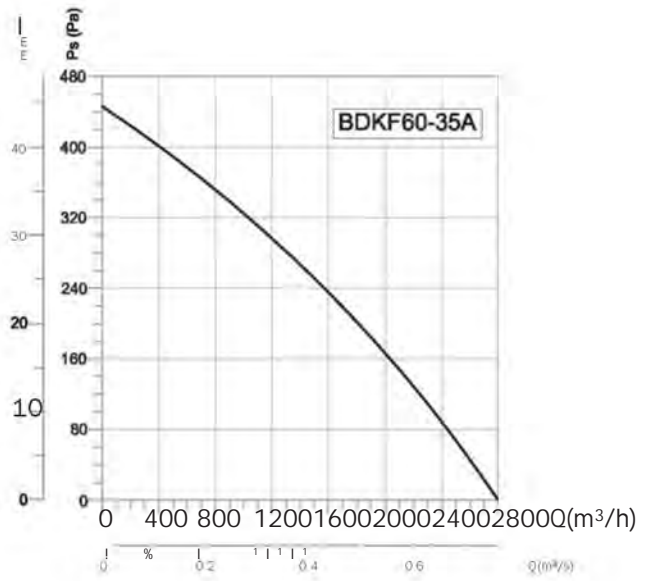
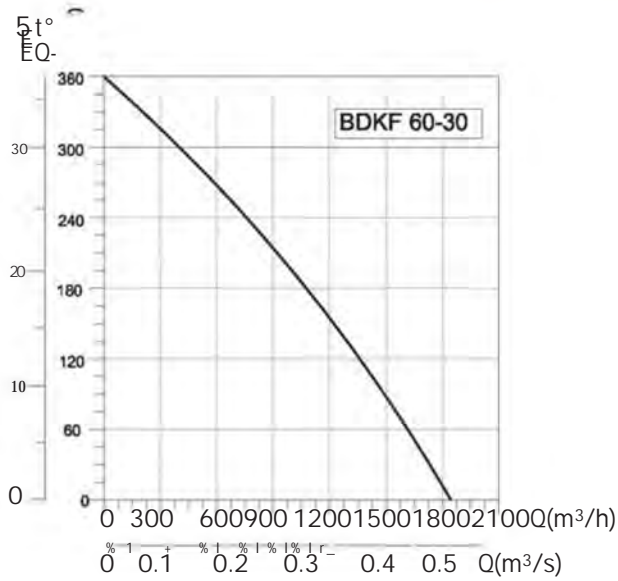

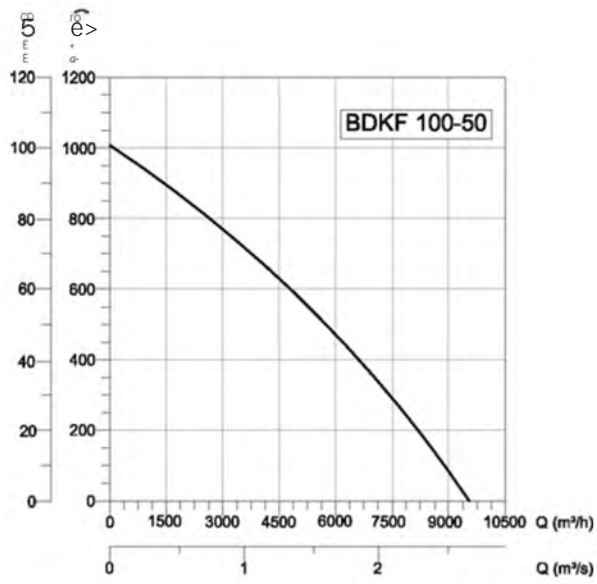

### Accessories



BSC

BSC-F



BDEB BDH BDKS



DUCT FANS

Roof Fan

^ ^ ^ ^

z < / > s < / > c < / > c

z < / > s < / > p

VENTILATION

SMOKE EXTRACT SYSTEMS

100-69 ° CIES

## DUCT FANS



# BDKF-R

AC DIRECT DRIVE RECTANGULAR IN LINE  
DUCT FANS  
Backward Curved

Motor is out of Airflow  
120°C

### Technical Drawings

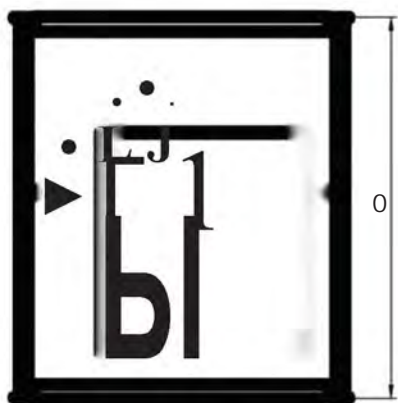
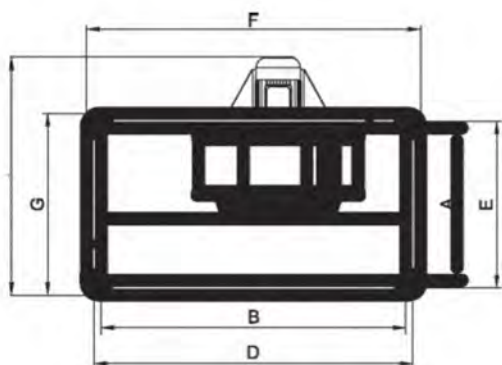

- MATERIAL** : Housing and backward inclined impeller is made of galvanized sheet metal.
- INSULATION CLASS** : Class F
- DIRECTIVE** : EN 60335-1, EN 60335-2-80
- SPEED CONTROL** : Speed can be adjusted using an optional controller.
- APPLICATION AREAS** : Kitchen exhaust applications, hotels, carparking areas, buildings, shopping malls etc.

TYPE	V	Hz	KW	(A)	d/d	m/h	dB(A)	kg
BDKF-R 315	230/380	50	0,25	1,8/0,81	1440	3000	68	35
BDKF-R 355	230/380	50	0,37	2,6/1,15	1420	3500	69	36
BDKF-R 400	230/380	50	0,55	3,3/1,5	1470	4700	75	49
BDKF-R 450	230/380	50	1	7,1/2,6	1450	6000	78	52
BDKFR500	230/380	50	1,5	9,3/3,5	1400	8400	80	74
BDKFR560	230/380	50	2,2	13,4/5,1	1440	10500	80	91

### Accessories



**BSC-F**

**BDEB**

**BDH**

**BDKS**

TYPE	A	B	C	D	E	F	G	H
BDKF-R 315	350	600	760	620	370	650	400	550
BDKF-R 355	350	600	760	620	370	650	400	550
BDKF-R 400	400	700	800	720	420	750	450	630
BDKF-R 450	400	700	800	720	420	750	450	630
BDKF-R 500	500	800	920	820	520	850	560	780
BDKF-R 560	500	1000	1050	1030	530	1060	560	780

Dimensions are in (mm)

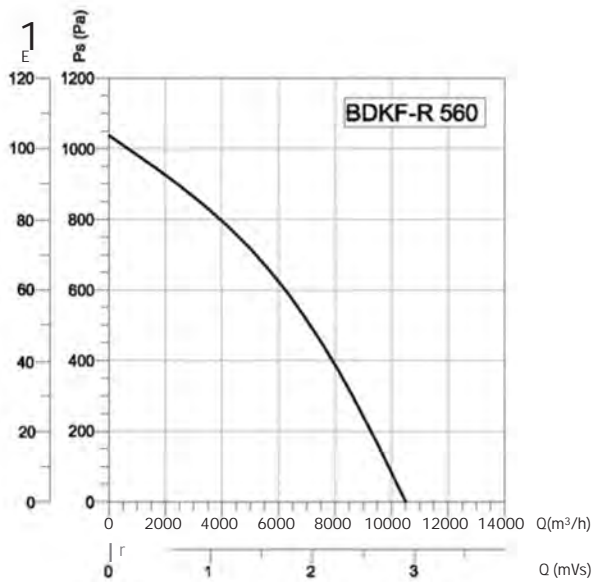
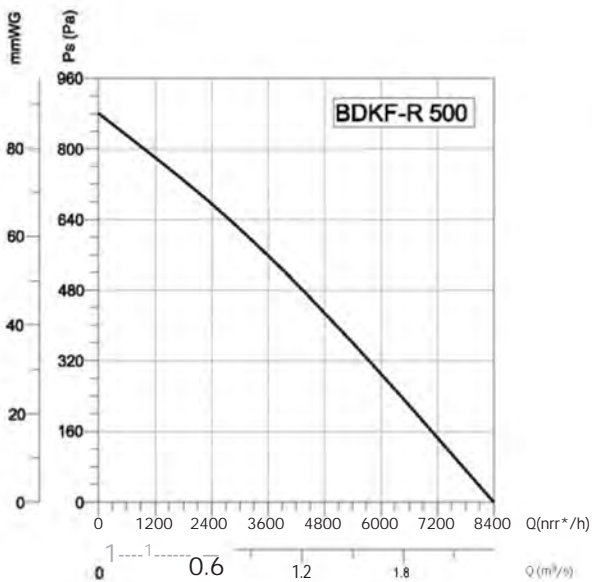
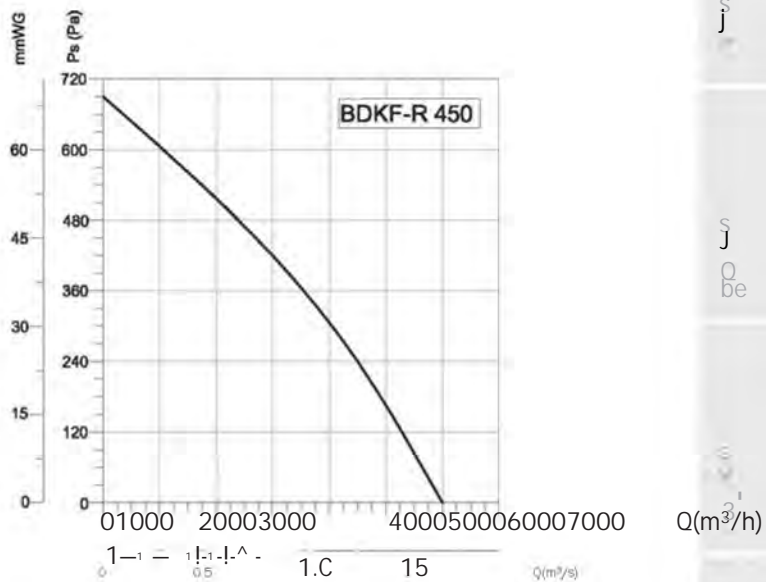
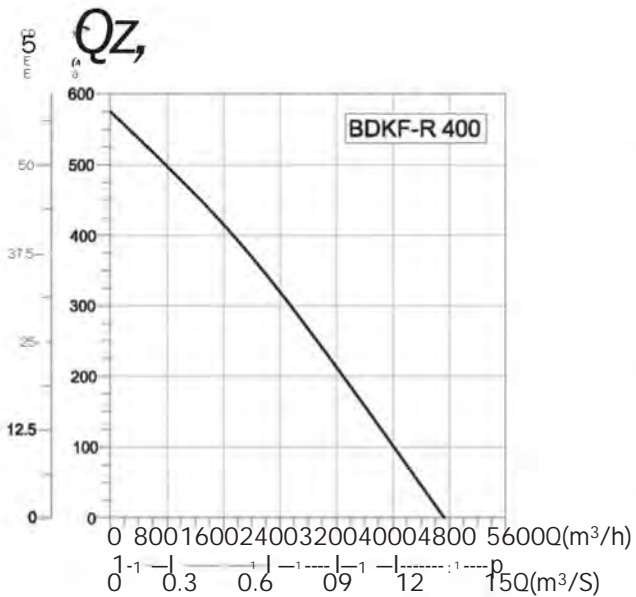
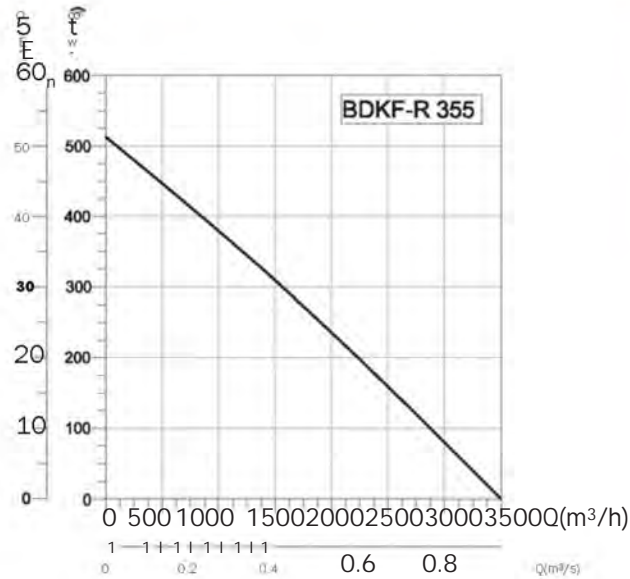
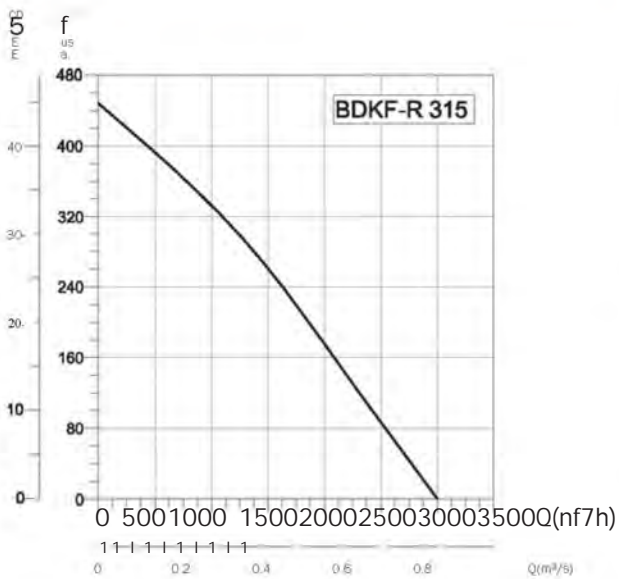

## DUCT FANS



# BKKF

## SQUARE DUCT FANS Backward Curved

Removable panels provide flexibility on air flow direction.  
Suitable mounting at each mounting position.  
Safe and no maintenance needed.  
Panels with double walls are manufactured of 20mm mineral wool isolated galvanize sheetsteel.

### Technical Drawings

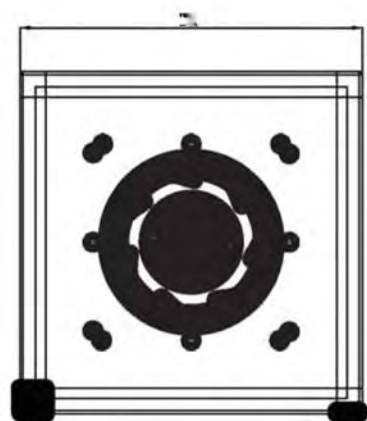

- MATERIAL** : Casing is made of galvanized sheet metal, fan with backward curved impeller is made of aluminium
- INSULATION CLASS** : Class F
- MAX. HAVATAŞINIMI** : 50 °C
- DIRECTIVE** : EN 60335-1, EN 60335-2-80
- SPEED CONTROL** : Speed can be adjusted using an optional controller.
- APPLICATION AREAS** : BKEF-R fan series are perfect to use in residential, commercial, and industrial environments, especially where pressured air is needed to be transferred. They are widely used in industrial kitchens, cafes and restaurants, as well as gymnasiums, shopping centers, hospitals, factories, offices etc. They are also used in Air Handling Units (AHU) for air Supply.

TYPE	A			D
BKKF400	670	670	610	270
BKKF450	670	670	610	283
BKKF 500	670	670	610	344
BKKF 560	800	800	740	382

Dimensions are in (m)

TYPE	VOLTAGE	$\frac{E}{LU}$ a ffi	POWER	CURRENT	SPEED	AIR FLOW	SOUND PRESSURE LEVEL	WEIGHT
	V	Hz	KW	(A)	d/d	m <sup>3</sup> /h	dB(A)	kg
BKKF400	230	50	345	1,5	1400	3900	50	36
BKKF450	230	50	620	2,8	1400	4800	55	40
BKKF 500	380	50	950	2,4	1400	7100	60	51
BKKF 560	380	50	1550	2,8	1400	9200	62	65

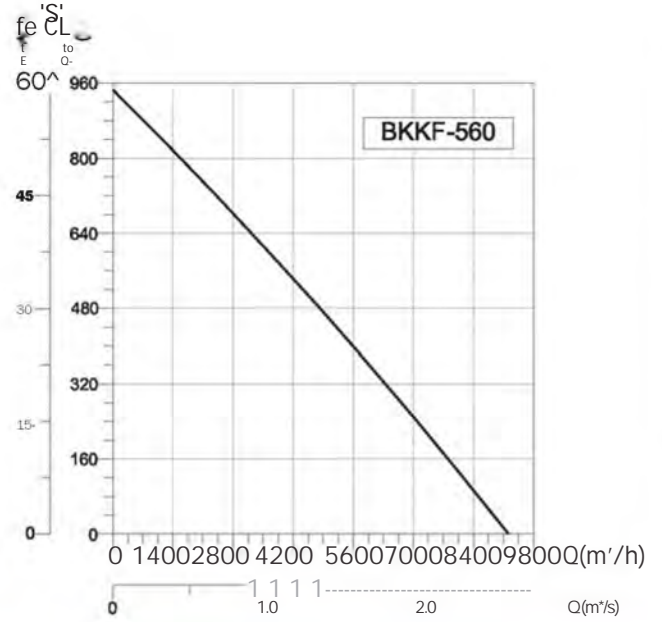
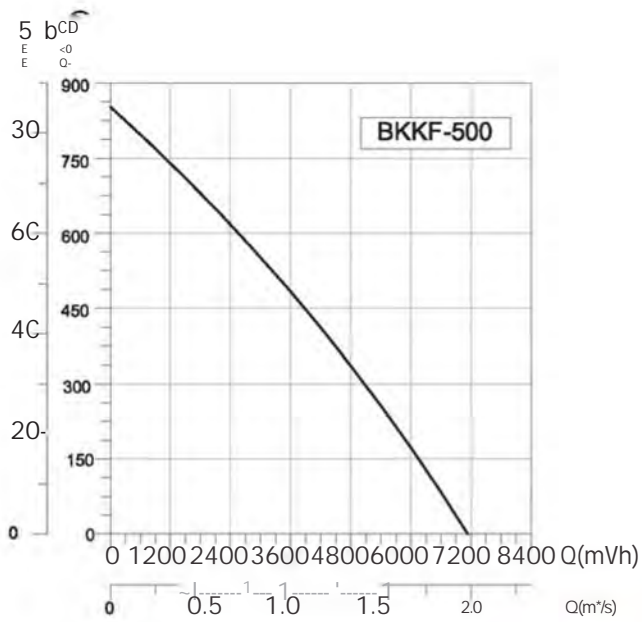
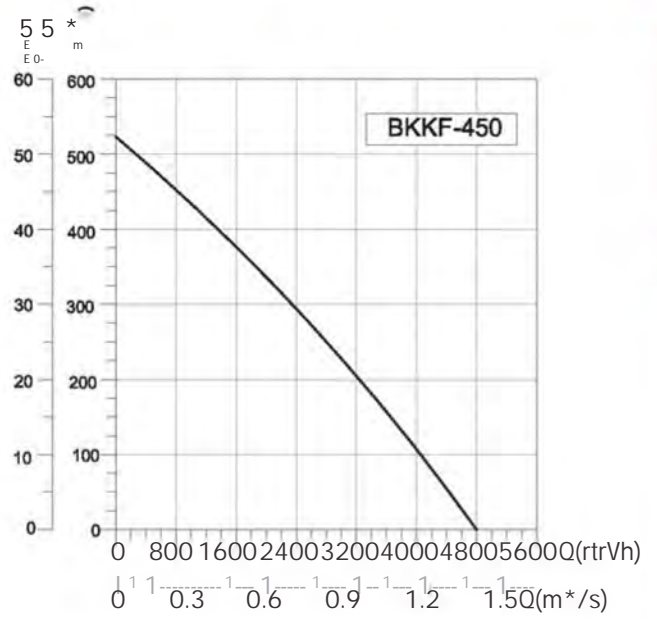
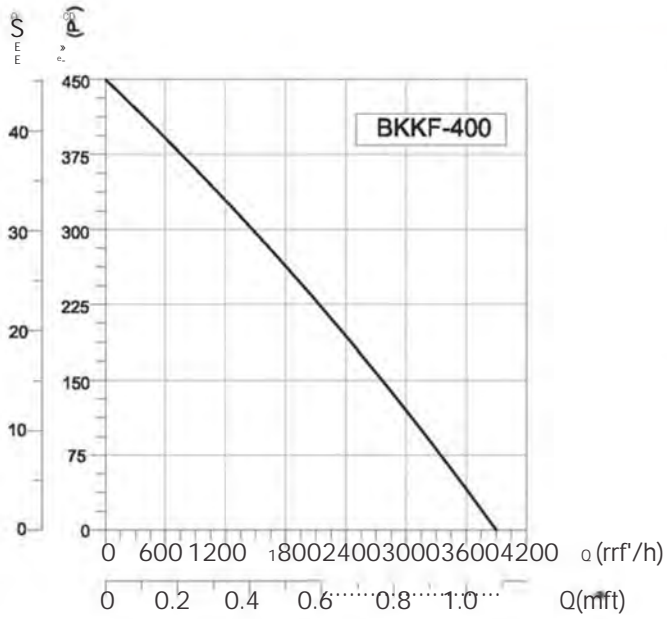

### Accessories



**BSC-F1 BDH**



**BDEB**





# DUCT FANS

## BSKF

### AC RECTANGULAR IN LINE DUCT FANS Forward Curved



Bahçivan Brand Rectangular In-Line Duct Fans engineered for medium and large ventilation needs where space is at a premium. BSKF Rectangular fans developed and manufactured for higher pressure performance, trouble-free, and direct-to-duct operations. The motorized impeller is mounted on a hinged door - the user just swings the door out for easy access to the impeller for maintenance.

#### Technical Drawings

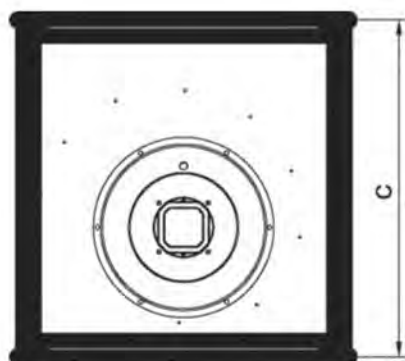
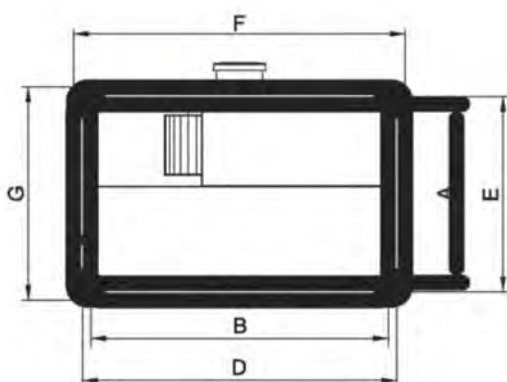

- MATERIAL** : The housing and impeller are galvanized sheet steel.
- INSULATION CLASS** : Class F
- DIRECTIVE** : EN 60335-1, EN 60335-2-80
- SPEED CONTROL** : Speed can be adjusted using an optional controller.
- APPLICATION AREAS** : BSKF series fans are perfect for commercial and industrial Ventilation use.

TYPE	W i S V	F R E Q U E N C Y H z	C O I L W W	1- P H A S E (A)	R E V O L U T I O N (MF)	S P E E D d/a	A I R F L O W m <sup>3</sup> /h	S O U N D P R E S S U R E L E V E L dB(A)	W E I G H T kg
BSKF 40-20	230	50	195	0,9	6	1420	990	58	14
BSKF 50-25	230	50	450	2	8	1395	1750	70	19
BSKF 50-30	230	50	590	2,6	14	1370	2100	72	23
BSKF 60-30	380	50	1320	2,7	-	1390	2950	75	36
BSKF 60-35	380	50	2630	1,5	-	1485	4250	70	44

TYPE	A	B	D	E	F	G
BSKF 40-20	198	398	502	420	220	240
BSKF 50-25	248	498	532	520	270	290
BSKF 50-30	298	498	562	520	320	340
BSKF 60-30	298	598	642	620	320	340
BSKF 60-35	348	600	720	620	370	390

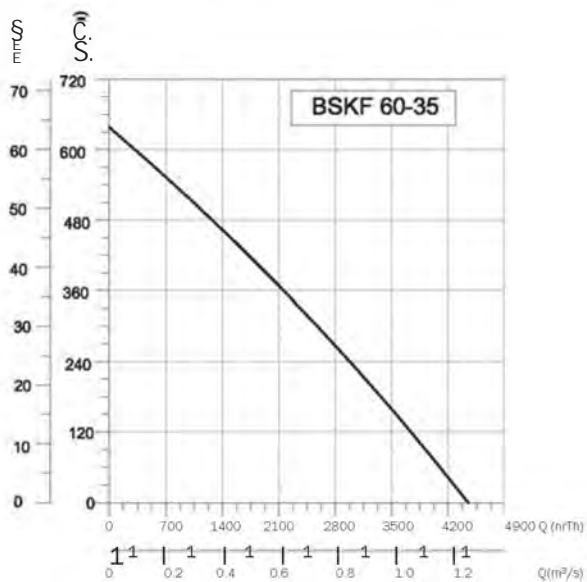
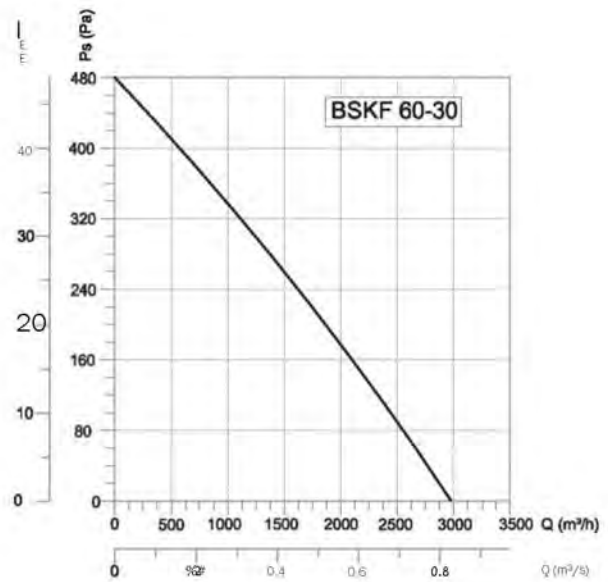
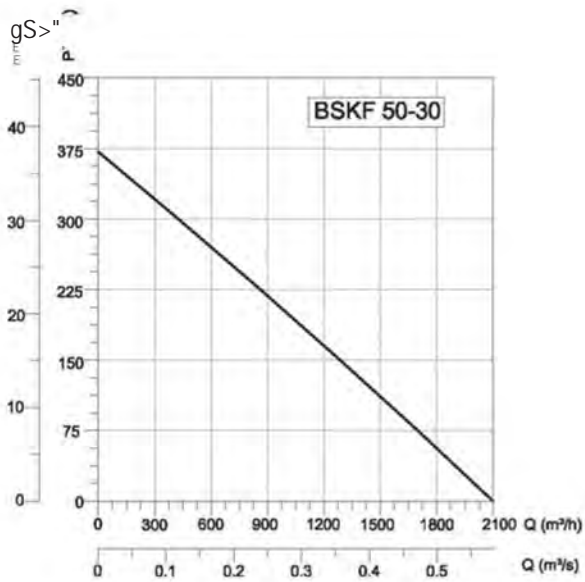
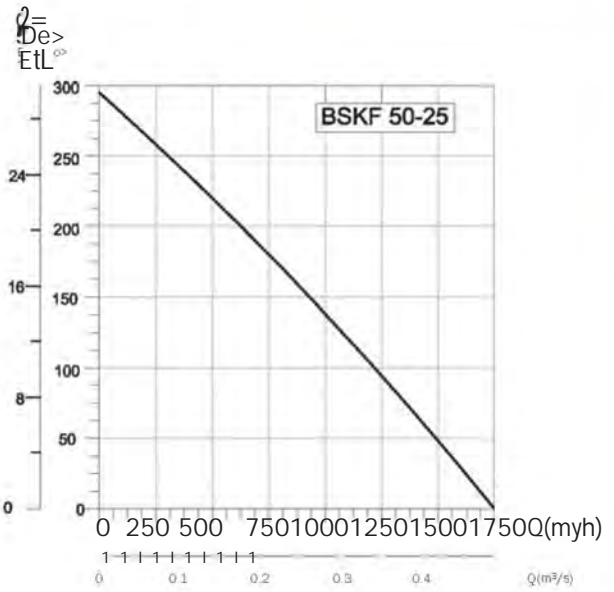
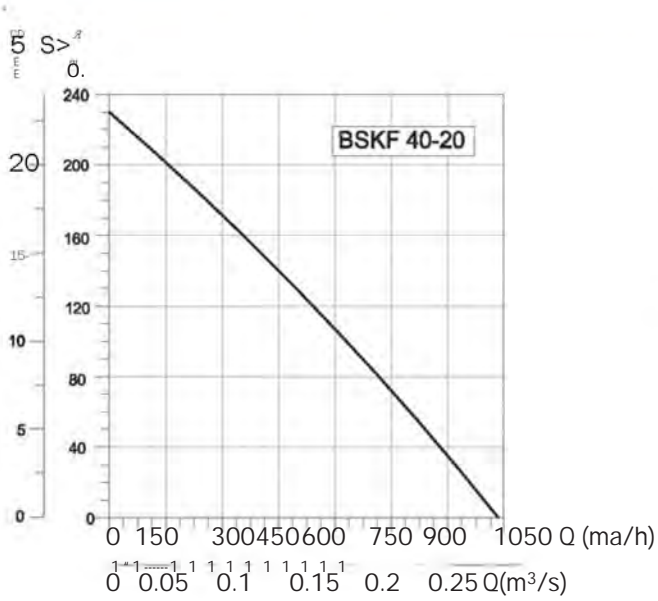

**Accessories**



BSC



BSC-F





BDEB BDH BDGS

DUCT FANS



## DUCT FANS



# BSKF-R

AC DIRECT DRIVE RECTANGULAR IN LINE  
DUCT FANS

**Forward Curved**

120°C

### Technical Drawings

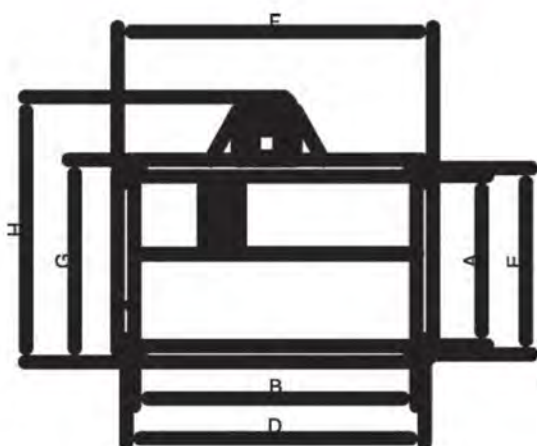

#### MATERIAL

- : Housing is made of galvanized sheet metal. Impeller is forward curved.

#### INSULATION CLASS

- : Class F

#### DIRECTIVE

- : EN 60335-1, EN 60335-2-80

#### SPEED CONTROL

- : Speed can be adjusted using an optional controller.

#### APPLICATION AREAS

- : Kitchen exhaust, hotels, autoparks, buildings, shopping centers etc.

TYPE	A			D	E	F	G	H
BSKF-R 200	200	400	500	420	220	450	250	469
BSKF-R 225	250	500	560	520	270	550	300	519
BSKF-R 250	300	500	560	520	320	550	350	589
BSKF-R 280	300	600	710	620	320	650	350	589
BSKF-R 315	350	600	710	620	370	650	400	684
BSKF-R 355	400	700	780	720	420	750	450	766
BSKF-R 400	500	800	880	820	520	850	550	866
BSKF-R 450	500	1000	980	1020	520	1050	550	886

Dimensions are in (mm)

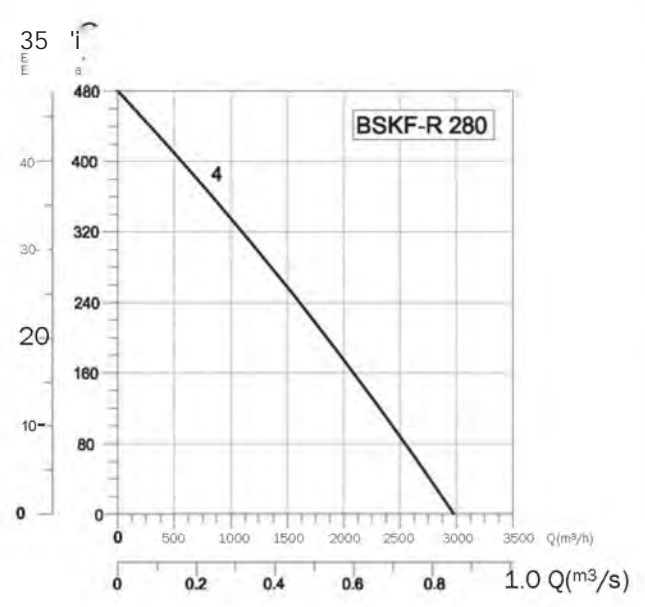
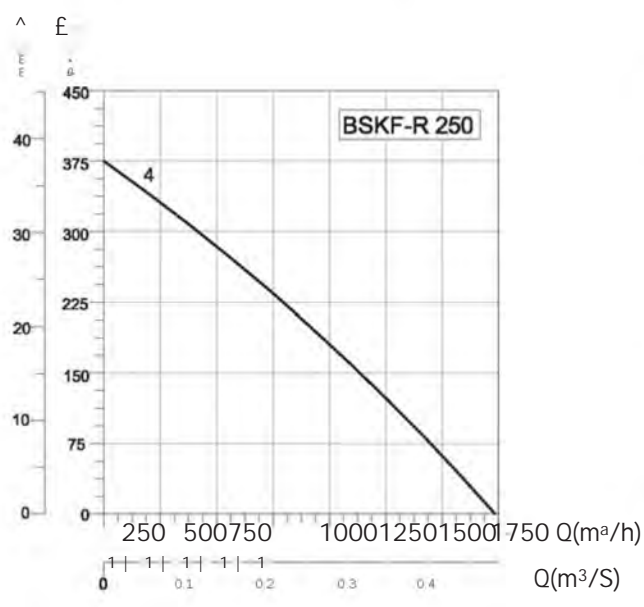
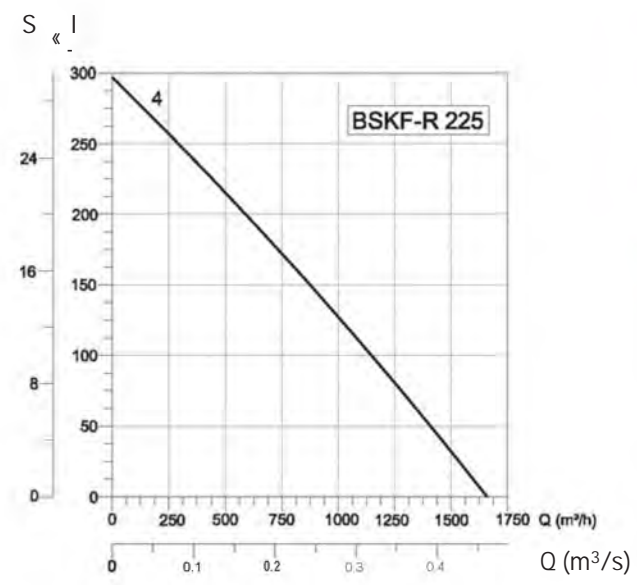
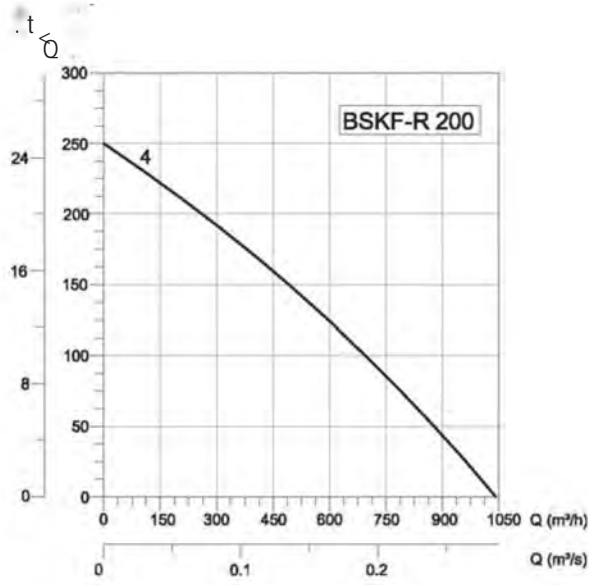

TYPE	V	Hz	Kw	(A)	d/d	m³/h	kg
BSKF-R 200-4	230/380	50	0,25	1,8/0,81	1400	1000	22
BSKF-R 225-4	230/380	50	0,37	2,6/1,15	1400	1673	35
BSKF-R 250-4	230/380	50	0,55	3,3/1,5	1400	1740	40
BSKF-R 280-4	230/380	50	0,75	4,6/2	1400	2942	43
BSKF-R 315-4	230/380	50	1,5	9,3/3,5	1400	4050	55
BSKF-R 315-6	380	50	0,37	1,1	900	2650	52
BSKF-R 355-4	230/380	50	2,2	13,4/5,1	1400	8000	85
BSKF-R 355-6	380	50	1,1	3	900	5200	81
BSKF-R 400-6	380	50	1,5	3,5	900	6000	92
BSKF-R 450-6	380	50	2,2	5,1	900	7500	120

DUCT FANS

11447 (A)

11447 (A)

Z</)

Z</)

(A)

VENTILATION

in

Accessories

# DUCT FANS

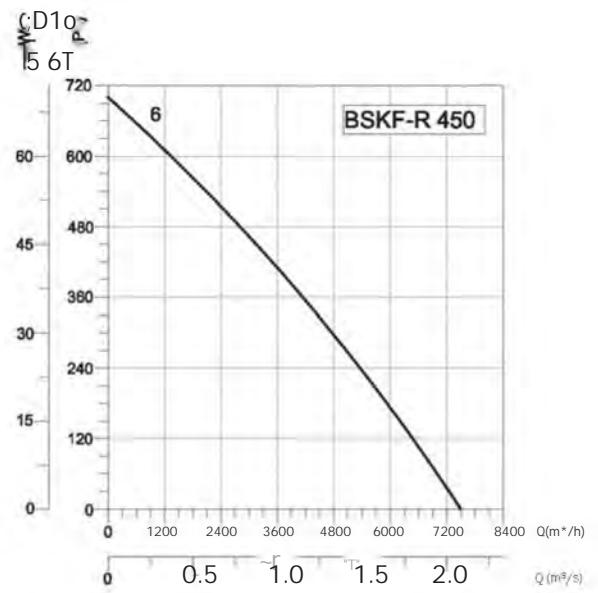
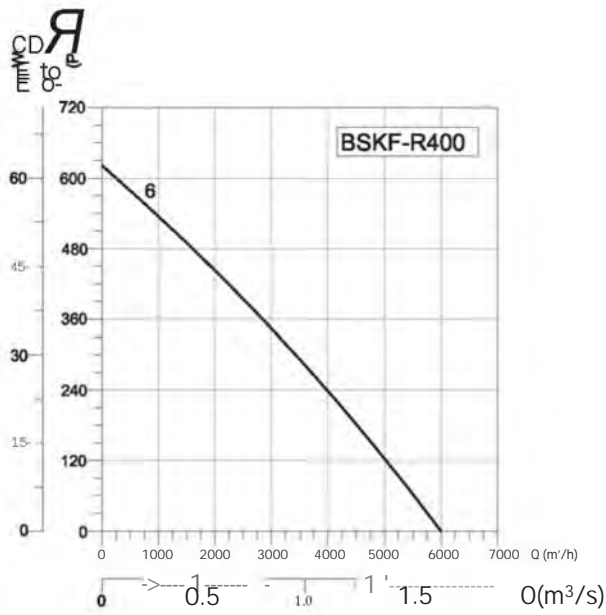
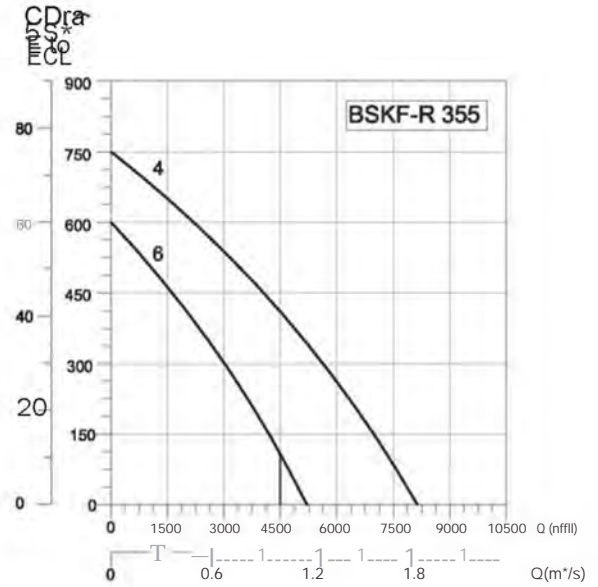
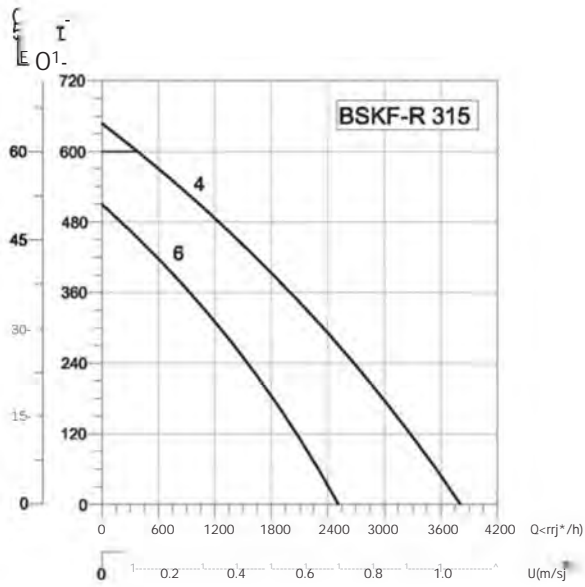

## Accessories



BSC



BSCF-



BDEB



BDH



BDKS



DUCT FANS

ROOF FANS

AXIAL FANS

RADIAL FANS

PLASTIC FANS

VENTILATORS

SMOKE EXHAUST SYSTEMS

ACCESSORIES

## DUCT FANS

# BKEF

### AC KITCHEN EXHAUST FANS

Backward Curved

To clean and serve easily; BKEF fans have an intervention cover on side, Fan connection and anti-vibration mountings are added to isolation bottom frame, The casing is manufactured from double-skinned galvanised sheet steel and insulated with 50 mm mineral wool, Low noise levels, Up to 120 degrees hot air can be transferred,

### Technical Drawings

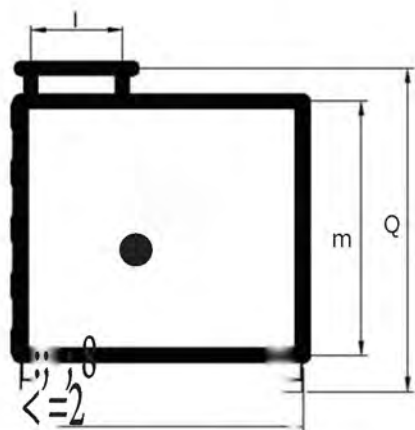
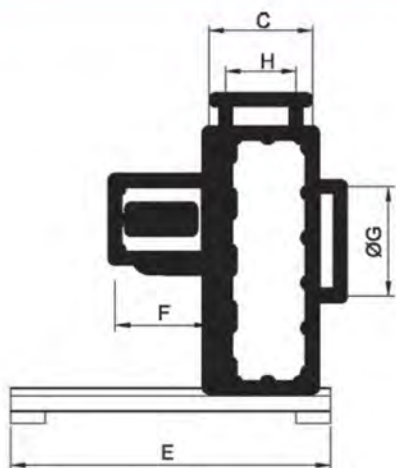

- MATERIAL** : Casing and fan with backward inclined impeller is made of galvanized sheet metal,
- INSULATION CLASS** : Class F
- MAX, HAVATAŞINIMI** : 120° C
- DIRECTIVE** : EN 60335-1, EN 60335-2-80
- SPEED CONTROL** : Speed can be adjusted using an optional controller
- APPLICATION AREAS** : BKEF fan series are perfect to use in residential, commercial, and industrial environments, especially where hot air and smoke is needed to be transferred, They are widely used in industrial kitchens, cafes and restaurants, as well as gymnasiums, shopping centers, hospitals, factories, offices etc,

TYPE	A			D	E	F	G	H	1
BKEF315	650	600	257	763	650	242	250	175	225
BKEF 355	730	656	267	823	650	242	280	183	256
BKEF 400	813	737	297	903	800	242	330	214	289
BKEF 450	900	813	314	980	800	242	348	231	323

Dimensions are in (mm)

TYPE	VOLTAGE	FREQUENCY	POWER	CURRENT	SPEED	AIR FLOW	SOUND PRESSURE LEVEL	WEIGHT
	v	Hz	KW	(A)	d/d	m <sup>3</sup> /h	dB(A)	kg
BKEF 315M/BKEF 315T	230/380	50	0,55	3,3/1,5	1400	2150	50	51
BKEF 355M / BKEF 355T	230/380	50	0,55	3,3/1,5	1400	3400	50	63
BKEF 400M/BKEF400T	230/380	50	0,75	4,6/2	1400	4000	60	78
BKEF 450M / BKEF 450T	230/380	50	0,75	4,6/2	1400	5000	60	87

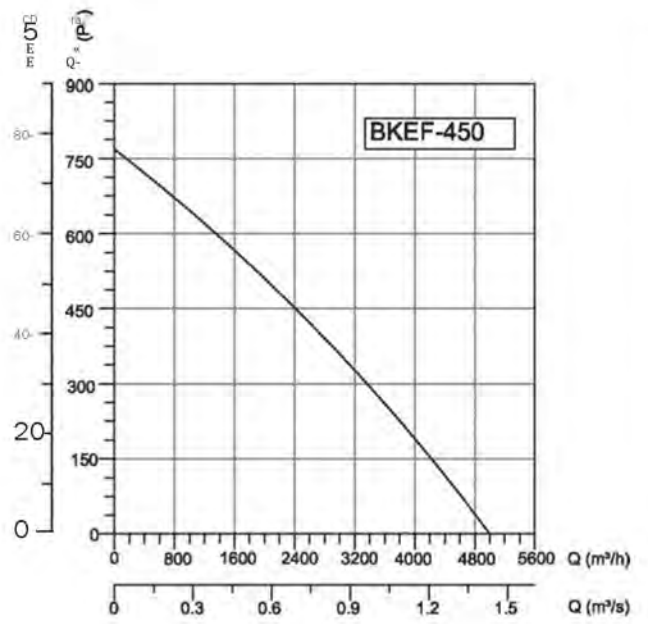
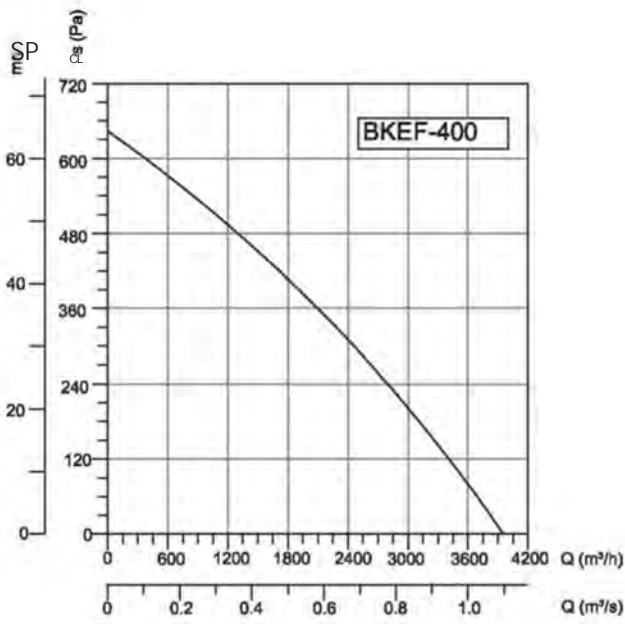
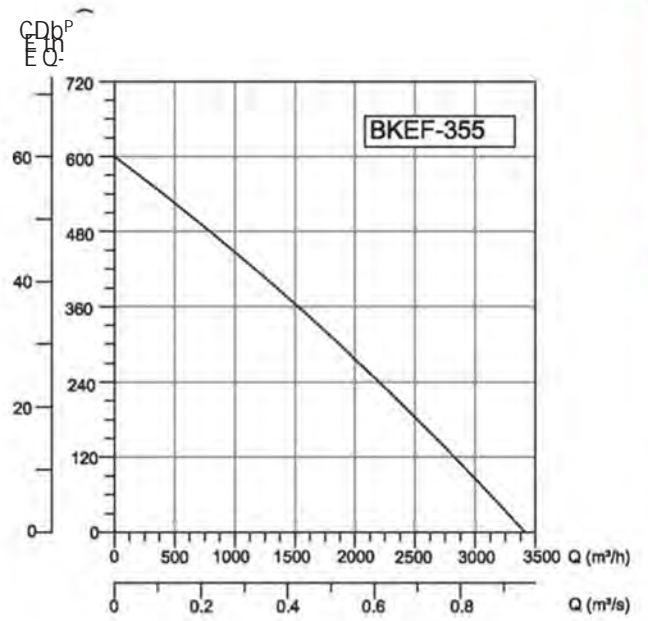
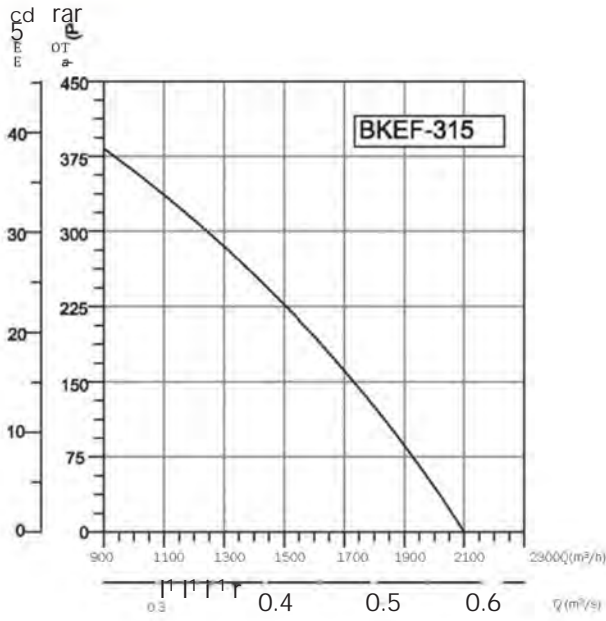

Accessories



BSC-F

BYH



## DUCT FANS



# BKEF-T

## AC KITCHEN EXHAUST FANS Forward Curved

The unit has a swing-out door for easy installation and service. The direction of the door opening can easily be changed from left to right. Fan connection and anti-vibration mountings are added to isolation bottom frame. The casing is manufactured from double-skinned galvanised sheet steel and insulated with 50 mm mineral wool. Up to 120 degrees hot air can be transferred. Low noise levels.

### Technical Drawings

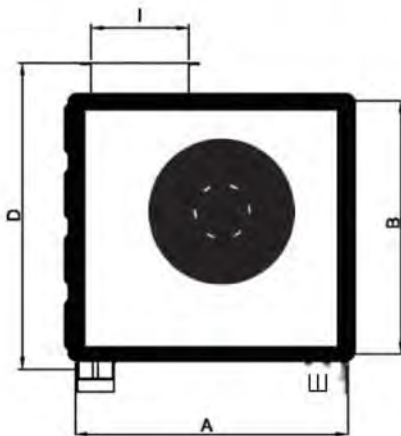
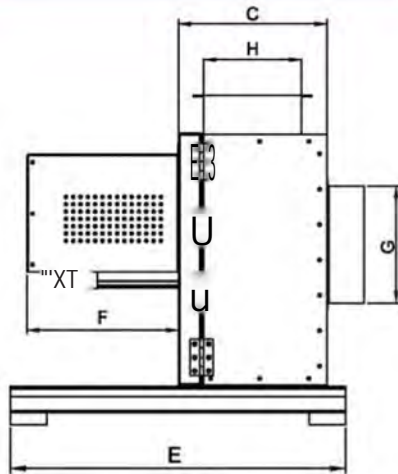

#### MATERIAL

: The housing and impeller are galvanized sheet steel.

#### INSULATION CLASS

: Class F

#### MAX. HAVATAŞINIMI

: 120°C

#### DIRECTIVE

: EN 60335-1, EN 60335-2-80

#### SPEED CONTROL

: Speed can be adjusted using an optional controller.

#### APPLICATION AREAS

: The BKEF-T fan series are perfect to use in residential, commercial, and industrial environments, especially where hot air and smoke is needed to be transferred. They are widely used in industrial kitchens, cafes and restaurants, as well as gymnasiums, shopping centers, hospitals, factories, offices etc.

### Accessories



BSC-F



BYH

TYPE	A			D	E	F	G	H	1
BKEF-T 160	372	345	202	480	470	227	160	127	115
BKEF-T 180	409	378	213	512	500	227	190	132	130
BKEF-T 200	445	409	224	544	500	266	210	142	143
BKEF-T 225	492	452	226	586	500	282	218	142	163
BKEF-T 250	535	490	246	625	550	316	254	162	179
BKEF-T 280	590	540	250	705	600	316	284	167	203
BKEF-T 315	650	600	272	758	650	405	333	188	225
BKEF-T 355	730	656	310	820	650	405	340	210	256

Dimensions are in (mm)

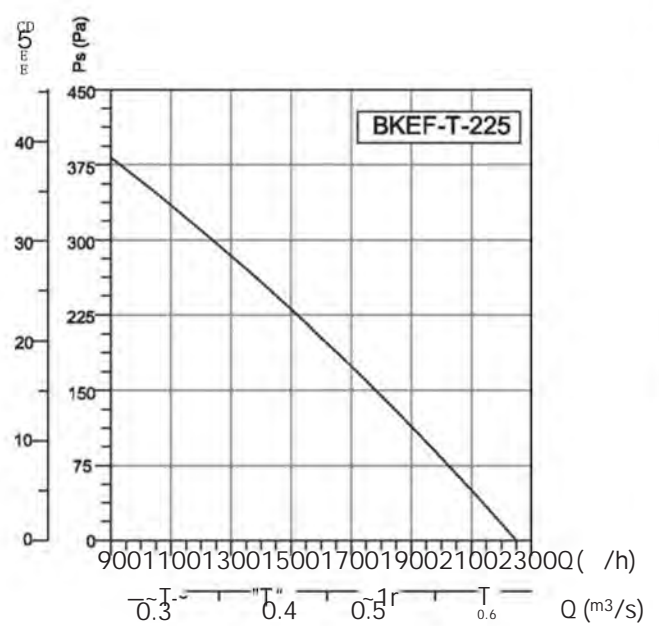
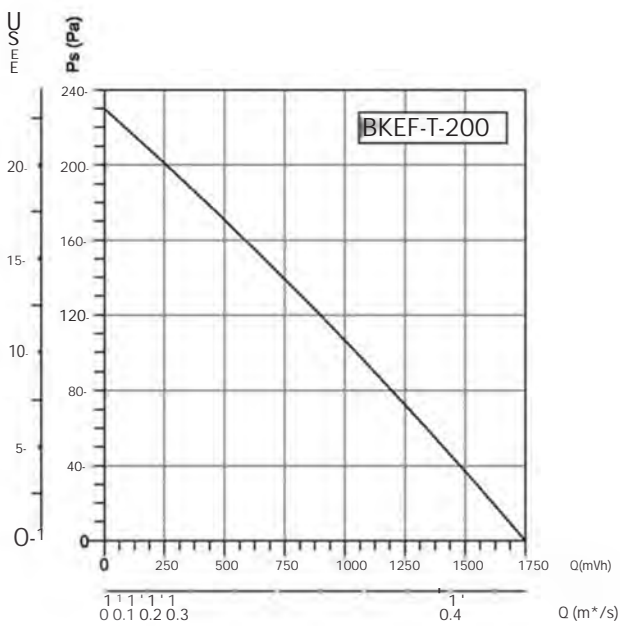
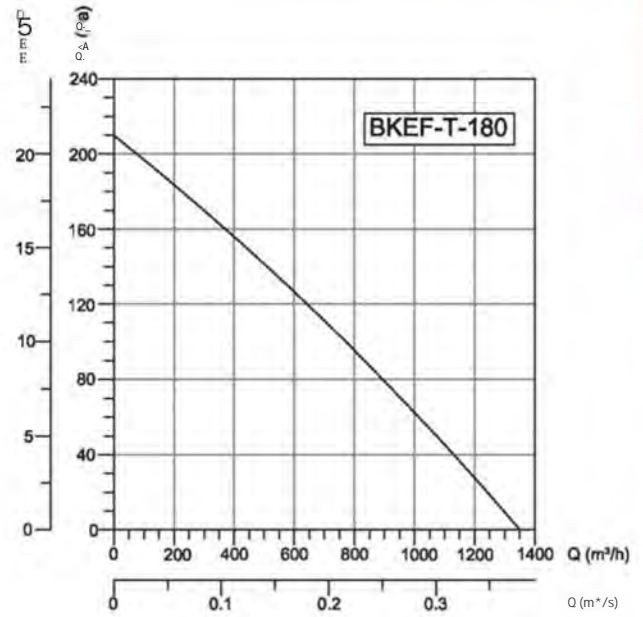
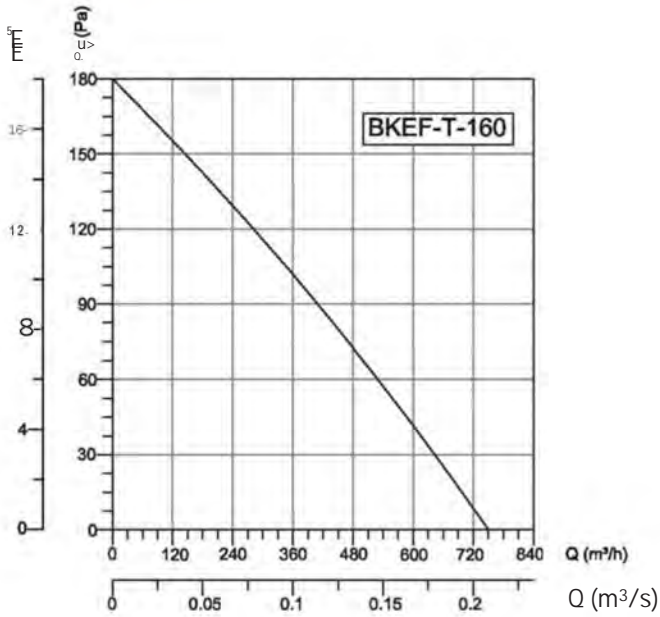

TYPE	1	FREQUENCY Hz	POWER KW	CURRENT (A)	SPEED d/d	AIR FLOW m³/h	SOUND PRESSURE LEVEL dB(A)	WEIGHT kg
	V							
BKEF-T 160M / BKEF-T 160T230/380	160	50	0,18	1,5/0,6	1330	750	45	25
BKEF-T 180M / BKEF-T 180T230/380	180	50	0,18	1,5/0,6	1330	1350	45	29
BKEF-T 200M / BKEF-T 200T230/380	200	50	0,55	3,3/1,5	1360	1750	50	40
BKEF-T 225M / BKEF-T 225T230/380	225	50	0,75	4,6/2	1360	2250	52	43
BKEF-T 250M / BKEF-T 250T230/380	250	50	1,5	9,3/3,5	1360	3500	55	52
BKEF-T 280M / BKEF-T 280T230/380	280	50	1,5	9,3/3,5	1330	4200	56	63
BKEF-T 315M / BKEF-T 315T230/380	315	50	3	19/6,45	1330	5000	58	78
BKEF-T 355T	380	50	3	6,9	900	6000	60	85

# DUCT FANS

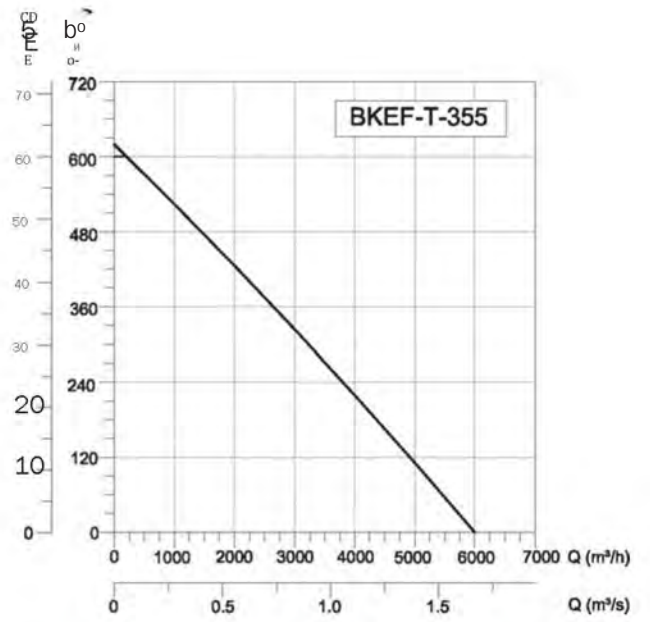
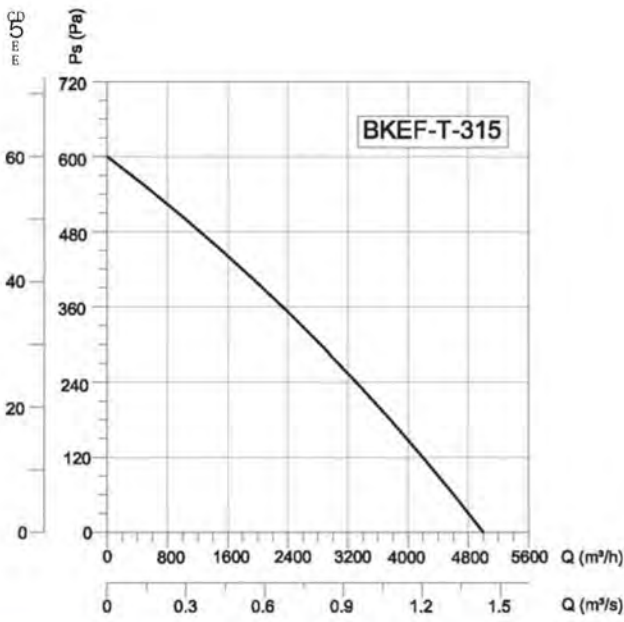
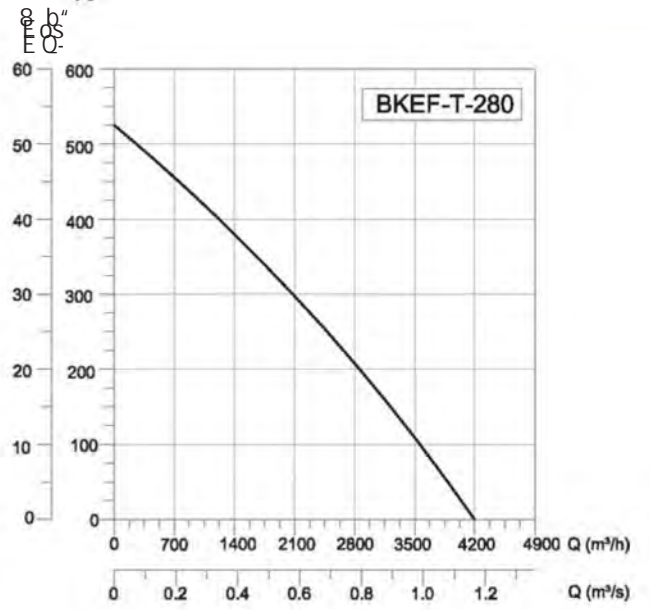
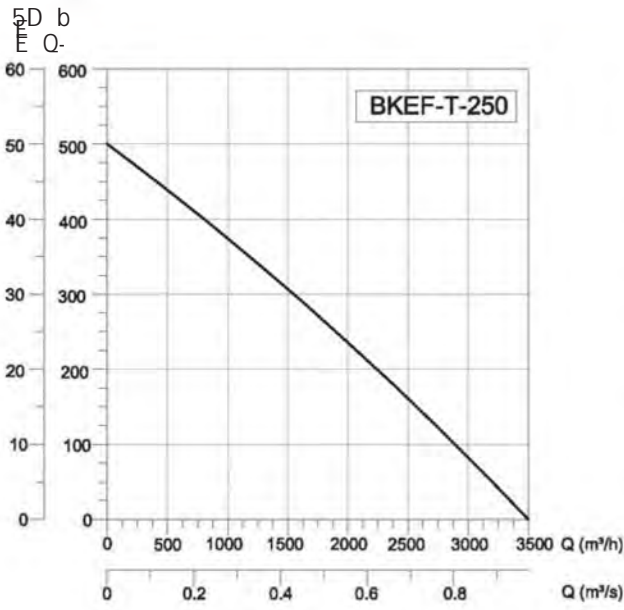



DUCT FANS

AXIAL FANS ROOF FANS

RADIAL FANS

ACCESSORIES SMOKE EXHAUST SYSTEMS VENTILATORS PLASTIC FANS

## DUCT FANS



# BKEF-R

## AC KITCHEN EXHAUST FANS Backward Curved

Removable panels provide flexibility on air flow direction.  
Suitable mounting at each mounting position.  
Safe and no maintenance needed.  
120°C

### Technical Drawings

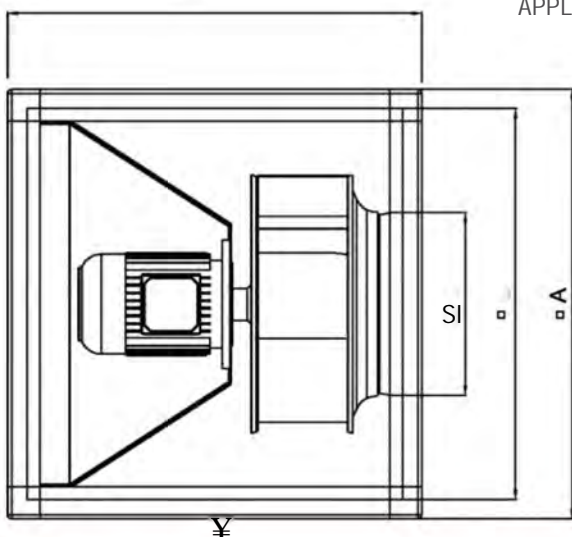

#### MATERIAL

- : Housing and backward inclined impeller is made of galvanized sheet metal.

#### INSULATION CLASS

- : Class F

#### DIRECTIVE

- : EN 60335-1, EN 60335-2-80

#### SPEED CONTROL

- : Speed can be adjusted using an optional controller.

#### APPLICATION AREAS

- : Kitchen exhaust applications, hotels, carparking areas, buildings, shopping malls etc.

### Accessories



BSC-F



BDEB



BDH



BDKS

TYPE	A			CD
BKEF-R 400	670	670	610	270
BKEF-R 450	670	670	610	282
BKEF-R 500	670	670	610	320
BKEF-R 560	800	800	740	360

Dimensions are in (mm)

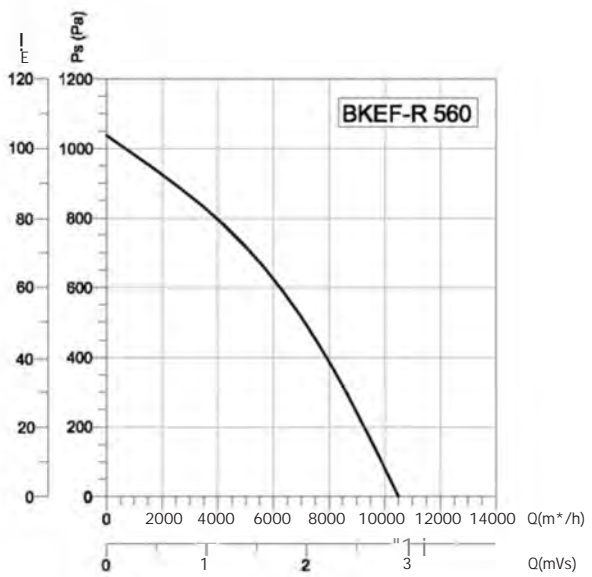
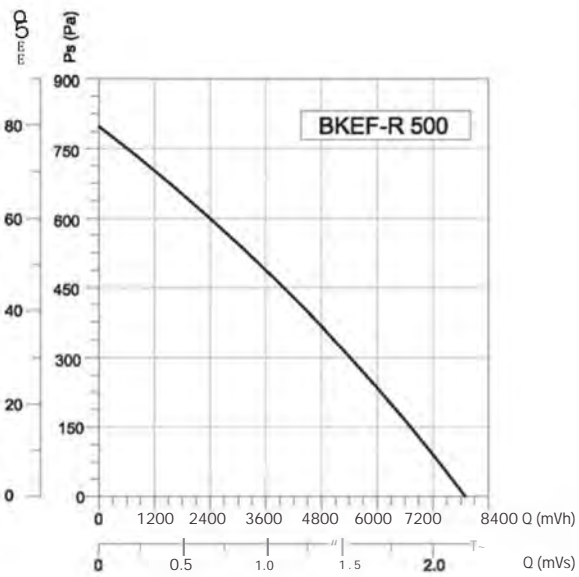
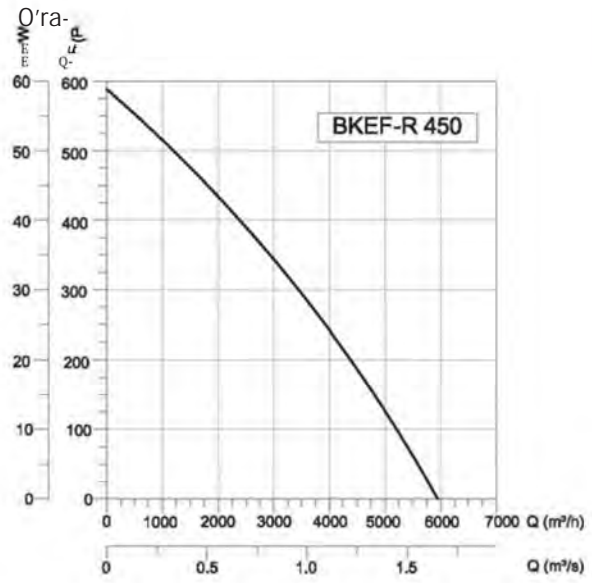
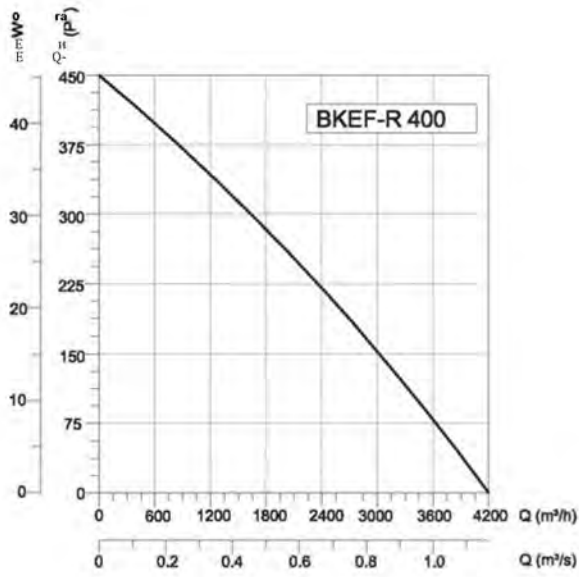

TYPE	VOLTAGE	FREQUENCY	POWER	CURRENT	SPEED	AIR FLOW	SOUND PRESSURE LEVEL	WEIGHT
	V	Hz	kW	(A)	d/d	m³/h	dB(A)	kg
BKEF-R 400	230/380	50	0,55	3,3/1,5	1400	4000	55	42
BKEF-R 450	230/380	50	0,75	4,6/2	1400	6000	57	55
BKEF-R 500	230/380	50	1,1	7,1/2,6	1400	8200	62	70
BKEF-R 560	230/380	50	1,5	9,3/3,5	1400	10500	70	95

## DUCT FANS



# BHV

## AC VENTILATION UNITS Forward Curved

BHV (double inlet fans) can be manufactured for the flow rates between 1800 and 20000 m<sup>3</sup>/h. Unit panels are covered with 20mm polyurethane. Max. efficiency with low energy. Acoustic isolated to noise and works vibration-free.



### MATERIAL

- : Housing is made of galvanized sheet metal and covered with 20mm polyurethane, aluminium cell, forward curved fan is made of galvanized sheet metal.

### INSULATION CLASS

- : Class F

### DIRECTIVE

- : EN 60335-1, EN 60335-2-80

### SPEED CONTROL

- : Speed is adjusted using belt pulley

### APPLICATION AREAS

- : Workplaces, offices, factories, hospitals, restaurants, meeting rooms, supermarkets, shopping centers etc.

### Technical Drawings

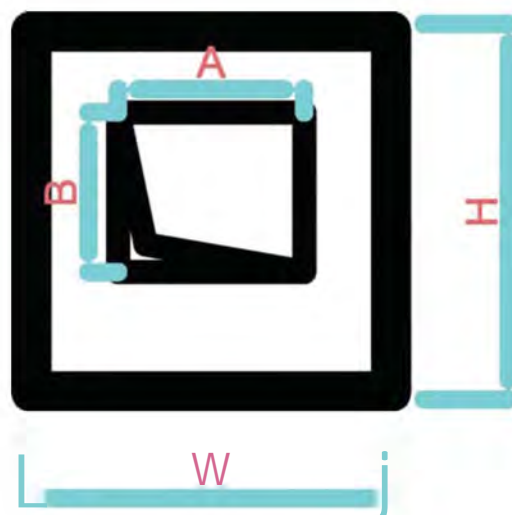
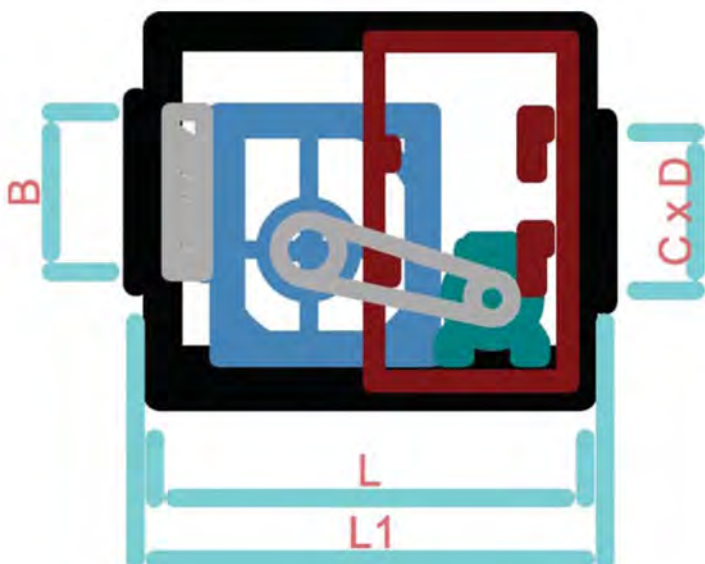



INLET - OUTLET POSITIONS

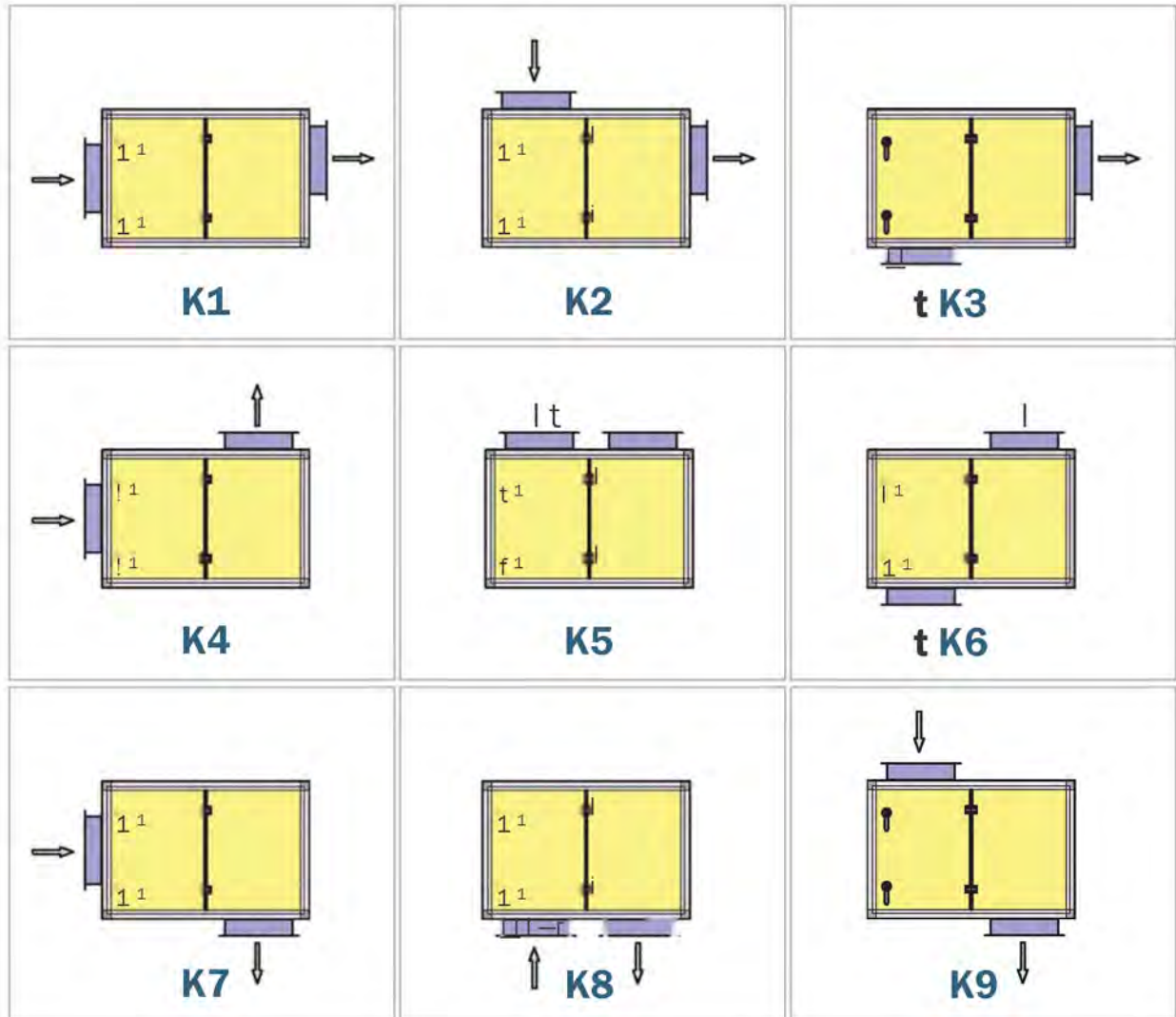

TYPE	L	w	H	A			D	LI
BHV 7	850	600	600	230	210	520	200	1050
BHV 9	950	700	700	293	262	620	250	1150
BHV 10	1050	750	750	330	290	670	350	1250
BHV 12	1100	850	850	400	340	770	400	1300
BHV 15	1200	900	900	470	405	820	500	1400
BHV 18	1300	1000	1000	560	480	920	650	1500

Dimensions are in (mm)



# DUCT FANS

TYPE	VOLTAGE	FREQUENCY	POWER	SPEED	AIR FLOW	a.	SOUND PRESSURE LEVEL	WEIGHT
	V	Hz	Kw	d/d	m <sup>3</sup> /h	f Pa		
BHV 7-A	220/380	50	0.25	1150	1800	180	49	65
BHV 7-B	220/380	50	0.37	1400	2100	220	51	66
BHV7-C	220/380	50	0.55	1520	2350	310	54	68
BHV 7-D	220/380	50	0.75	1680	2600	380	57	69
BHV9-A	220/380	50	0.37	990	2500	250	52	75
BHV9-B	220/380	50	0.55	1080	3200	280	53	76
BHV9-C	220/380	50	0.75	1200	3500	300	58	77
BHV9-D	220/380	50	1.1	1300	4000	350	59	80
BHV 10-A	220/380	50	0.55	870	3800	200	52	83
BHV 10-B	220/380	50	0.75	1000	4200	250	55	84
BHV10-C	220/380	50	1.1	1070	4800	300	58	87
BHV 10-D	220/380	50	1.5	1270	5300	400	60	89
BHV 12-A	220/380	50	0.75	765	5000	200	53	111
BHV 12-B	220/380	50	1.1	920	5500	300	56	114
BHV 12-C	220/380	50	1.5	990	6000	350	58	115
BHV 12-D	220/380	50	2.2	1080	7000	400	61	120
BHV 15-A	220/380	50	0.75	605	6000	190	53	128
BHV 15-B	220/380	50	1.1	700	7000	250	55	129
BHV15-C	220/380	50	1.5	765	7800	300	57	131
BHV 15-D	220/380	50	2.2	880	9000	400	60	135
BHV 18-A	220/380	50	1.5	550	10000	200	57	175
BHV 18-B	220/380	50	2.2	610	11000	250	57	176
BHV18-C	220/380	50	3	690	12000	330	59	177
BHV 18-D	380	50	4	690	13000	300	62	180

## Accessories



BSC-F



BDEB



BDH



BDKS



# BHV 7

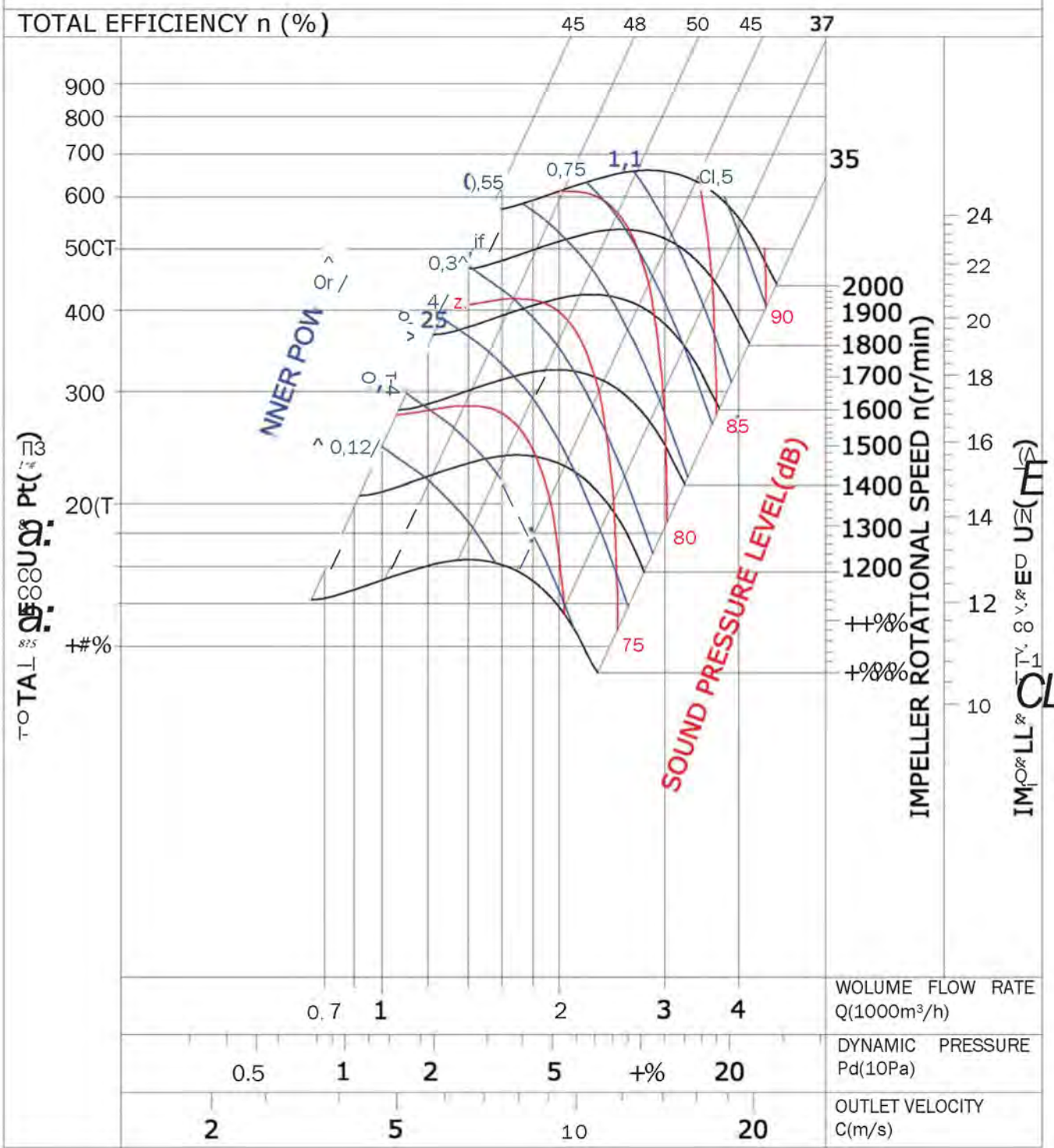

# BHV 9

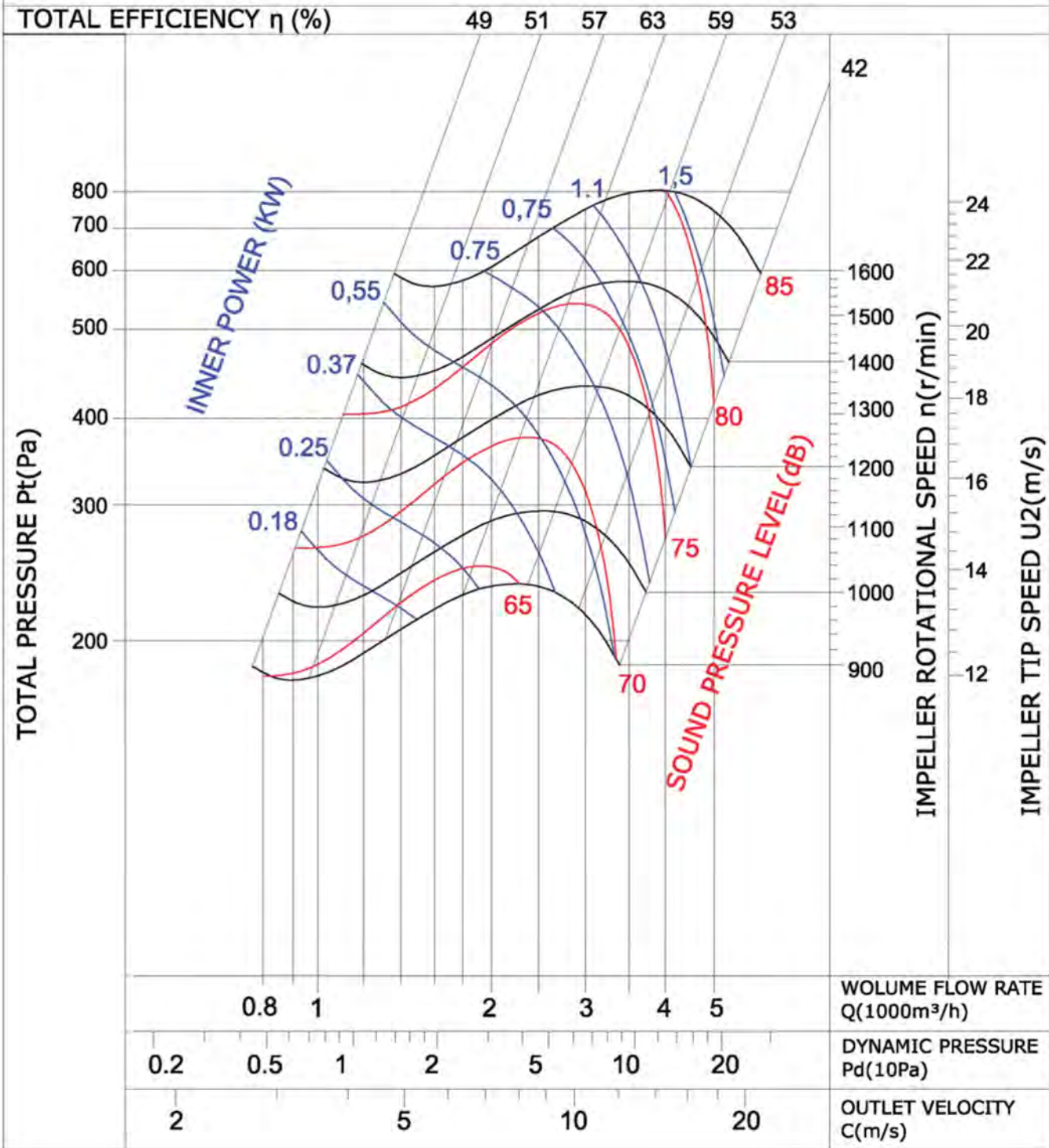



# BHV 10

TOTAL EFFICIENCY  $\eta$  (%)

49 52 58 61 56 51

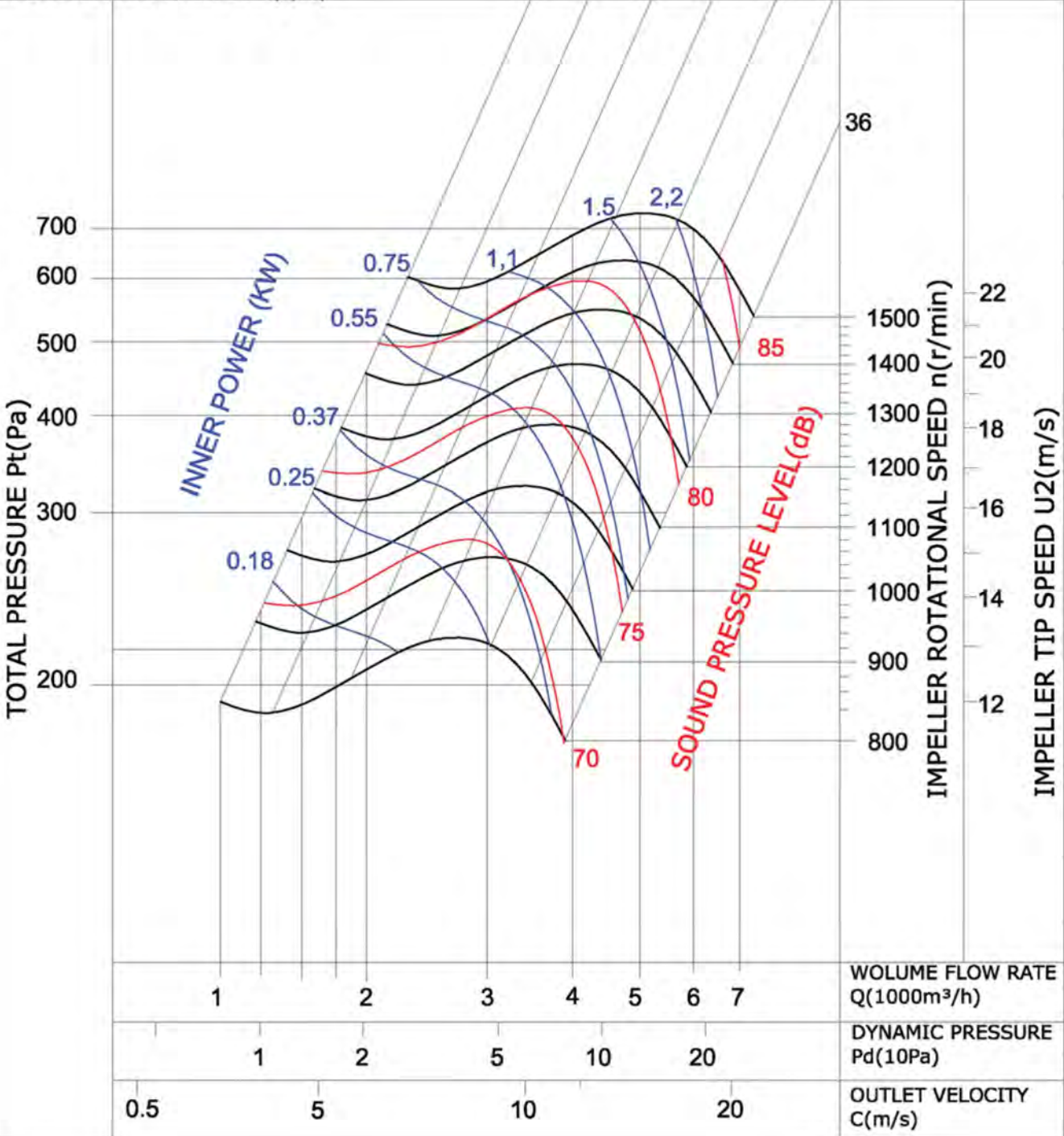

# DUCT FANS

## BHV 12

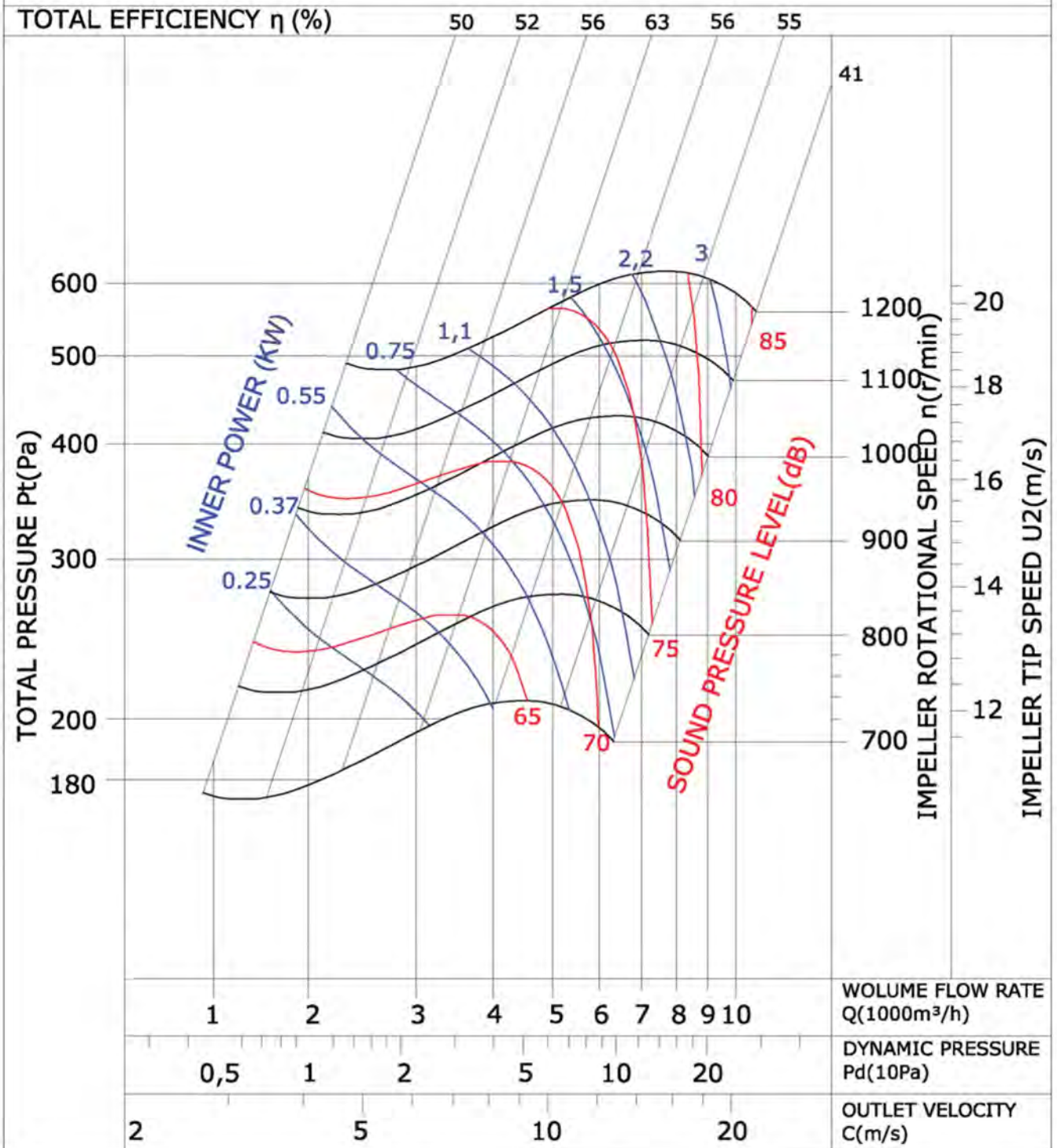



# BHV 15

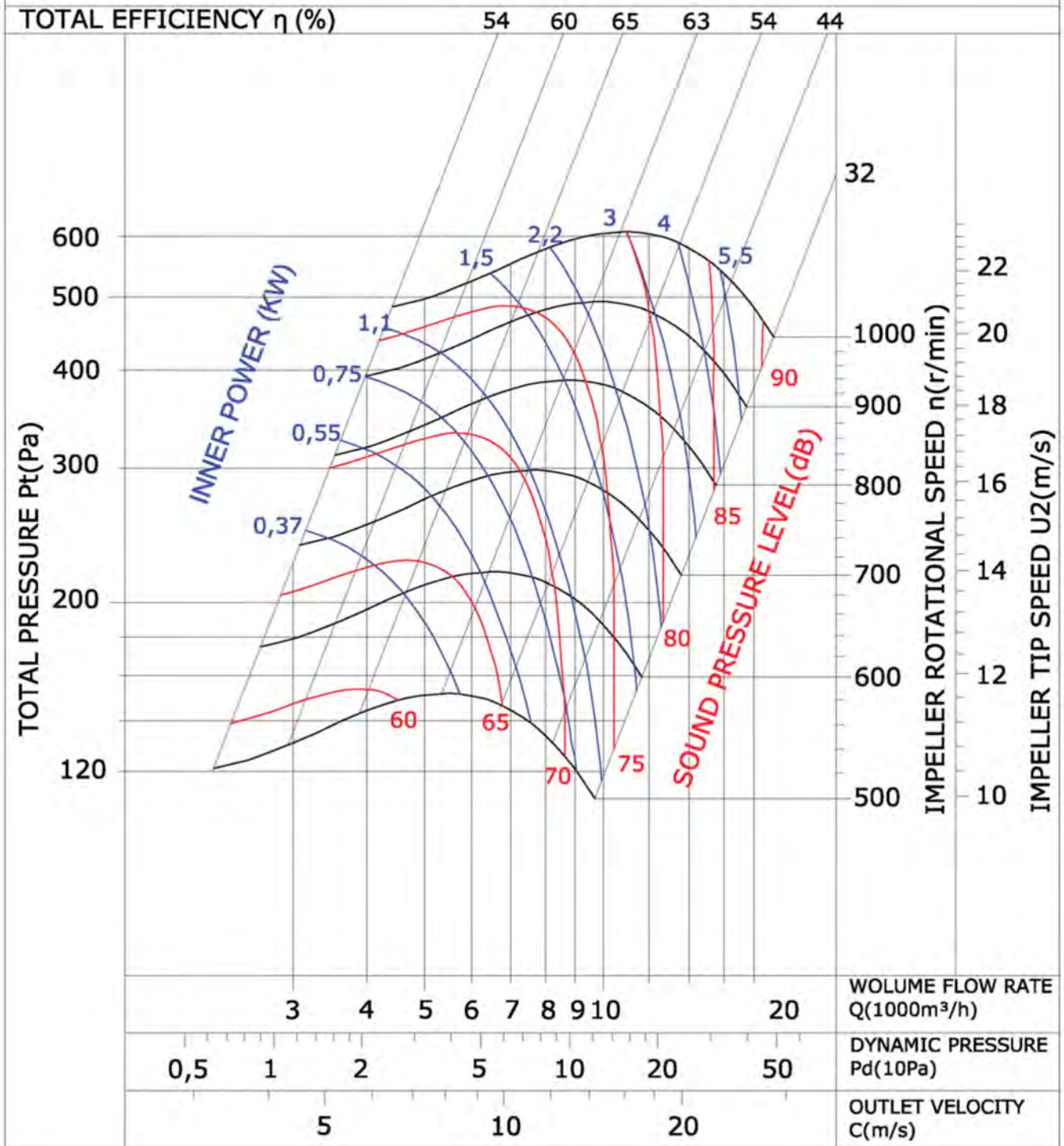

# BHV 18

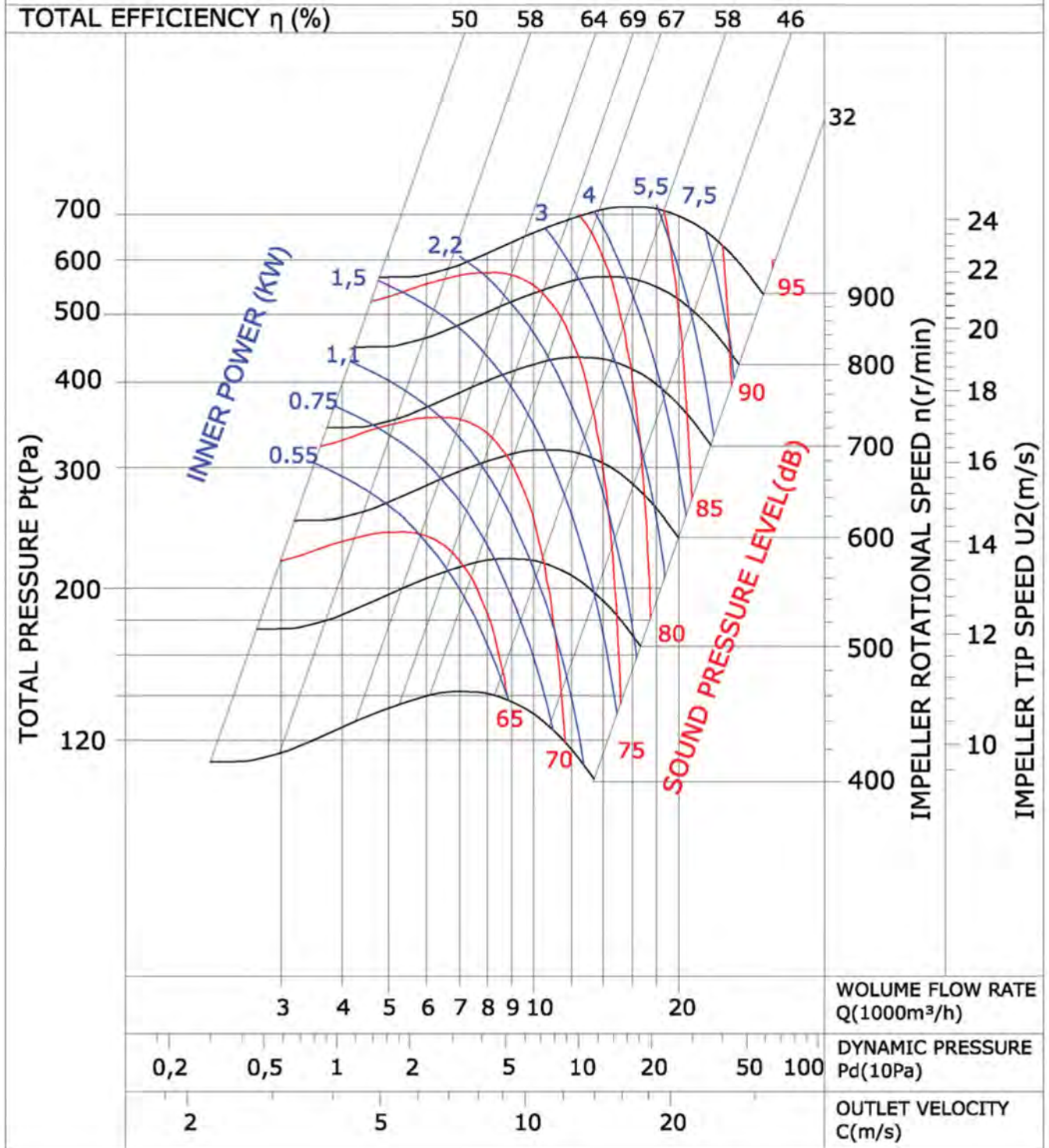



DUCT FANS

AXIAL FANS ROOF FANS

RADIAL FANS

ACCESSORIES SMOKE EXHAUST SYSTEMS VENTILATORS PLASTIC FANS



## DUCT FANS

# BHV-R

AC VENTILATION UNITS

Backward Curved



BHV-R (double inlet fans) can be manufactured for the flow rates between 4600 and 22400 m<sup>3</sup>/h, Unit panels are covered with 20mm polyurethane. Max. efficiency with low energy. Acoustic isolated to noise and works vibration-free.

MATERIAL

: Housing is made of galvanized sheet metal and covered with 20mm polyurethane, aluminium cell, backward curved fan is made of sheet metal with welded execution.

INSULATION CLASS  
DIRECTIVE

: Class F  
: EN 60335-1, EN 60335-2-80

SPEED CONTROL

: Speed is adjusted using belt pulley.

APPLICATION AREAS

: Workplaces, offices, factories, hospitals, restaurants, meeting rooms, supermarkets, shopping centers etc.

### Technical Drawings

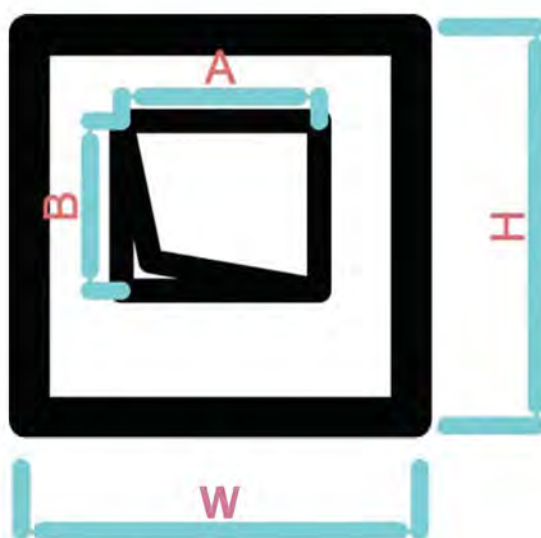
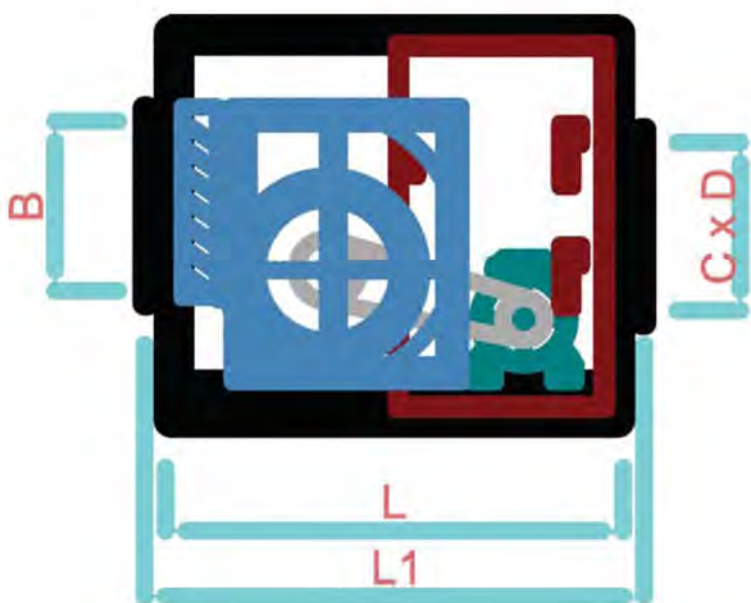



### INLET - OUTLET POSITIONS

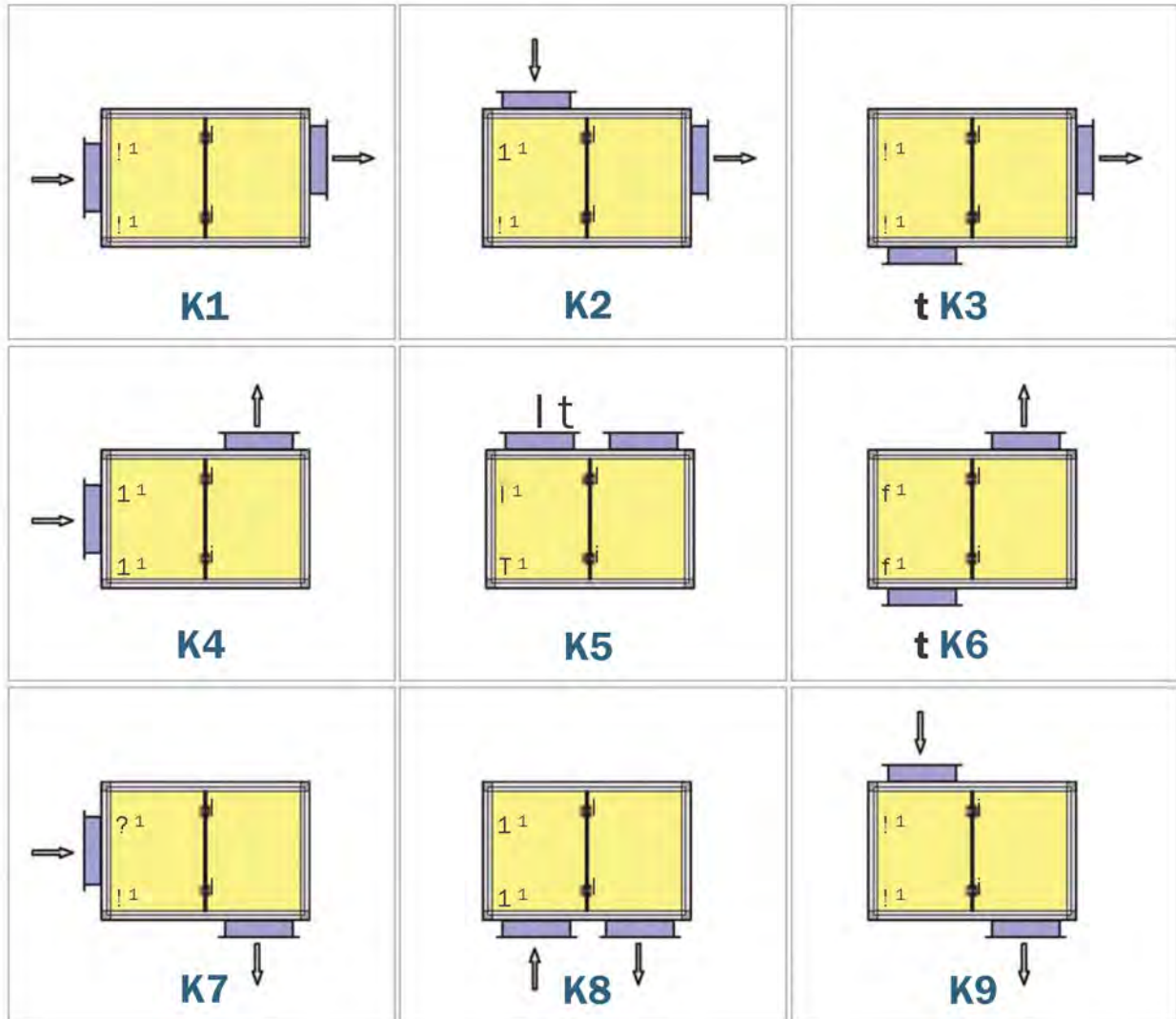

TYPE	L	w	H	A			D	LI
BHV-R 250	1050	750	750	322	322	670	300	1250
BHV-R 280	1050	750	750	360	360	670	300	1250
BHV-R 315	1100	850	850	405	405	770	400	1300
BHV-R 355	1200	900	900	455	455	820	450	1400
BHV-R 400	1300	1000	1000	510	510	920	500	1500
BHV-R 450	1400	1100	1100	570	570	1020	550	1600
BHV-R 500	1600	1200	1200	630	630	1120	600	1800

Dimensions are in (mm)

# DUCT FANS

TYPE	V	FREQUENCY	POWER	SPEED	AIR FLOW	PRESSURE	SOUND PRESSURE LEVEL	WEIGHT
	V	Hz	Kw	d/d	m <sup>3</sup> /h	Pa	dB(A)	kg
BHV-R 250-A	220/380	50	0,37	2050	1500	420	59	83
BHV-R 250-B	220/380	50	0,55	2330	2000	520	66	86
BHV-R 250-C	220/380	50	0,75	2500	2300	550	69	87
BHV-R 280-A	220/380	50	0,55	1920	2000	500	65	94
BHV-R 280-B	220/380	50	0,75	2200	2500	620	66	97
BHV-R 280-C	220/380	50	1,1	2400	3000	700	70	100
BHV-R 315-A	220/380	50	1,5	2250	4000	800	68	115
BHV-R 315-B	220/380	50	2,2	2550	5000	1000	70	118
BHV-R 315-C	220/380	50	3	2680	6000	1000	71	120
BHV-R 355-A	220/380	50	2,2	2100	5000	900	66	142
BHV-R 355-B	220/380	50	3	2300	6500	1000	70	144
BHV-R 355-C	220/380	50	4	2450	8000	1000	73	145
BHV-R 400-A	220/380	50	3	1950	6000	1000	69	181
BHV-R 400-B	380	50	4	2030	8500	1000	73	184
BHV-R 400-C	380	50	5,5	2250	11500	1000	78	201
BHV-R 450-A	220/380	50	3	1650	7000	900	69	232
BHV-R 450-B	380	50	4	1750	9000	1000	71	235
BHV-R 450-C	380	50	5,5	1870	12000	1000	75	252
BHV-R 500-A	380	50	4	1480	10000	1000	71	290
BHV-R 500-B	380	50	5,5	1610	13000	1000	74	307
BHV-R 500-C	380	50	7,5	1670	15000	1000	76	312
BHV-R 560-A	380	50	5,5	1380	12000	1000	65	350
BHV-R 560-B	380	50	7,5	1400	16000	1000	67	355
BHV-R 560-C	380	50	11	1550	22000	1000	70	384

## Accessories



BSC-F



BDEB



BDH



BDGS



# BHV-R 250

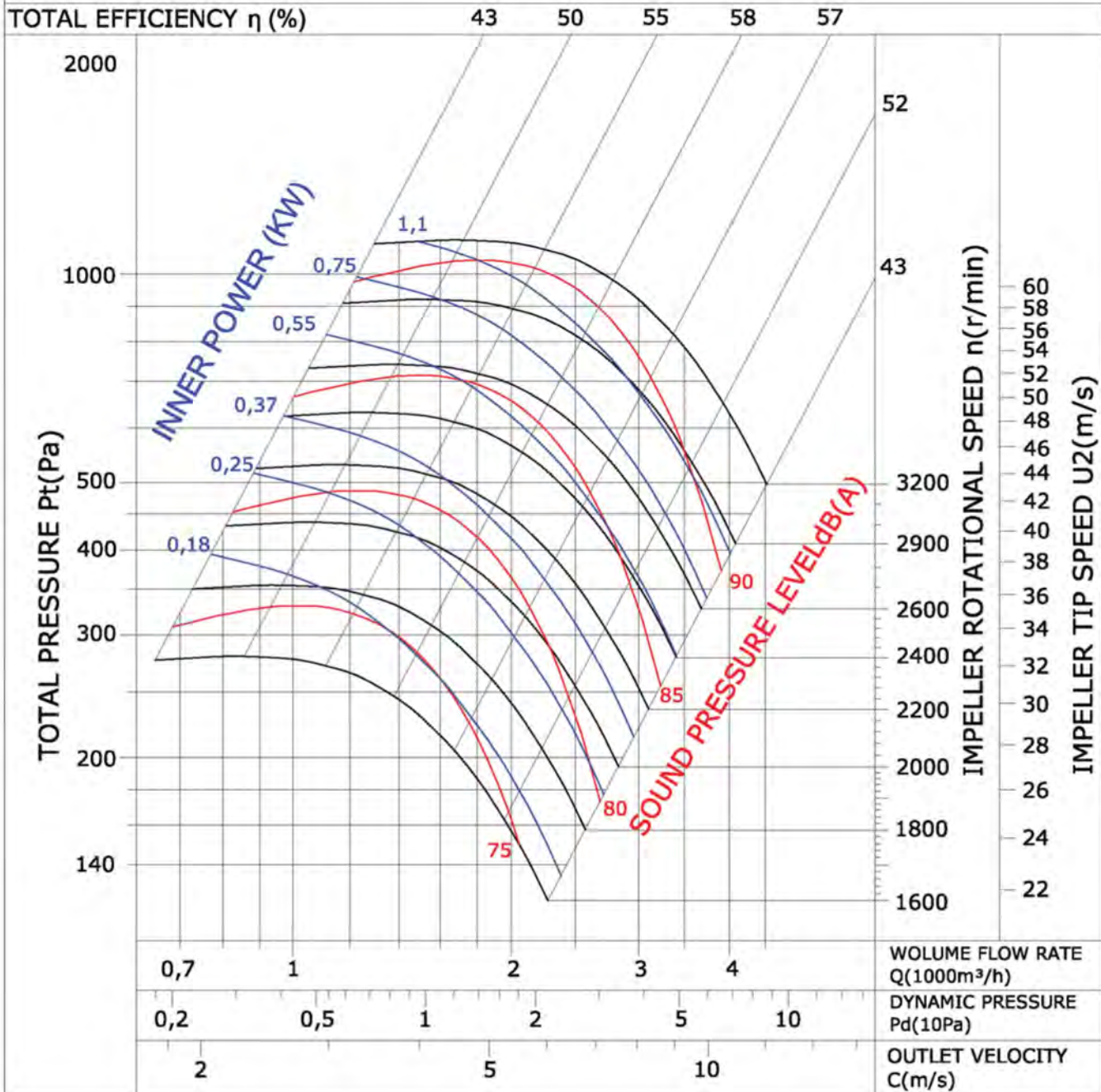

# BHV-R 280

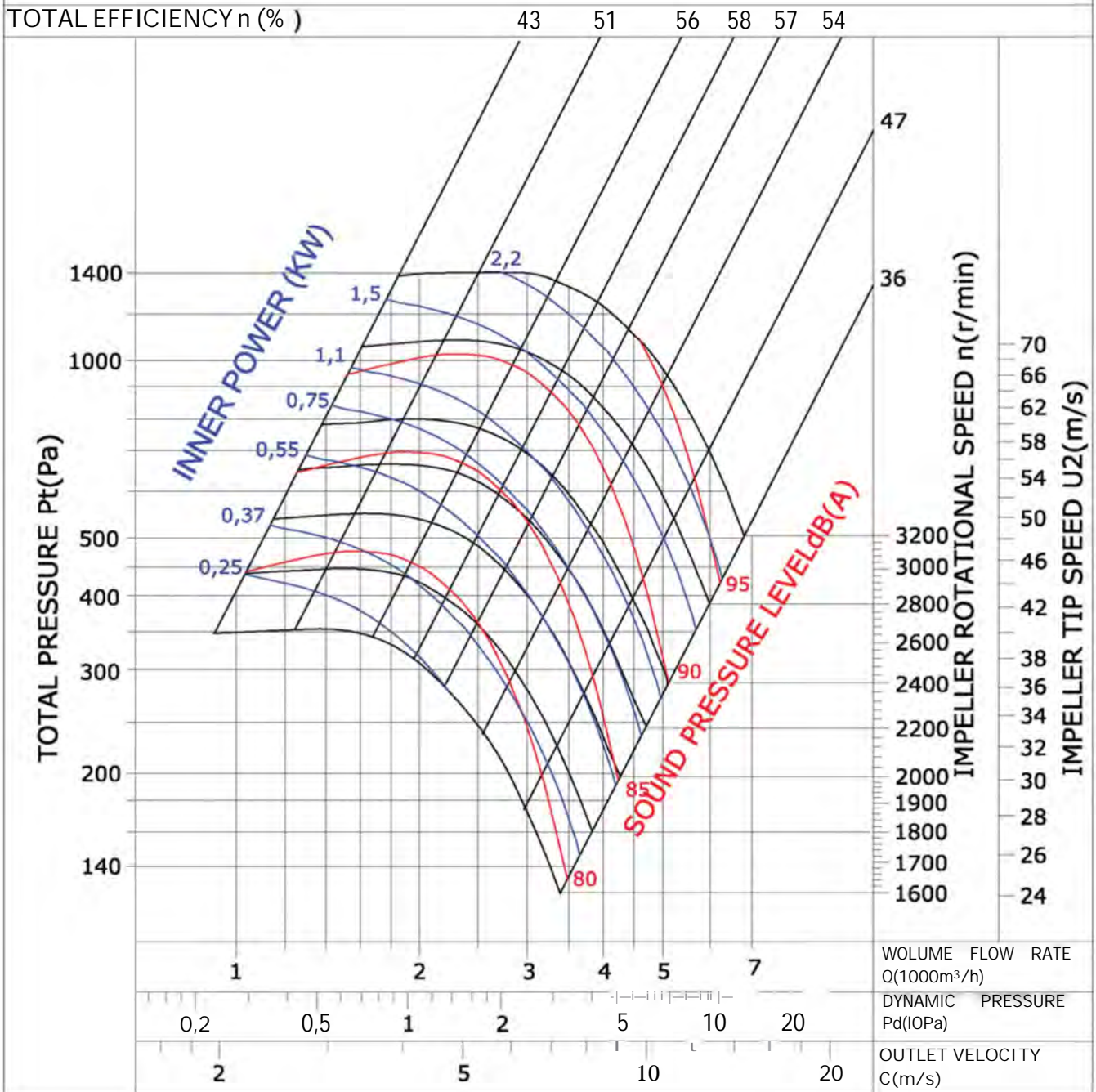



# BHV-R 315

TOTAL EFFICIENCY  $\eta$  (%)

63 70 74 71

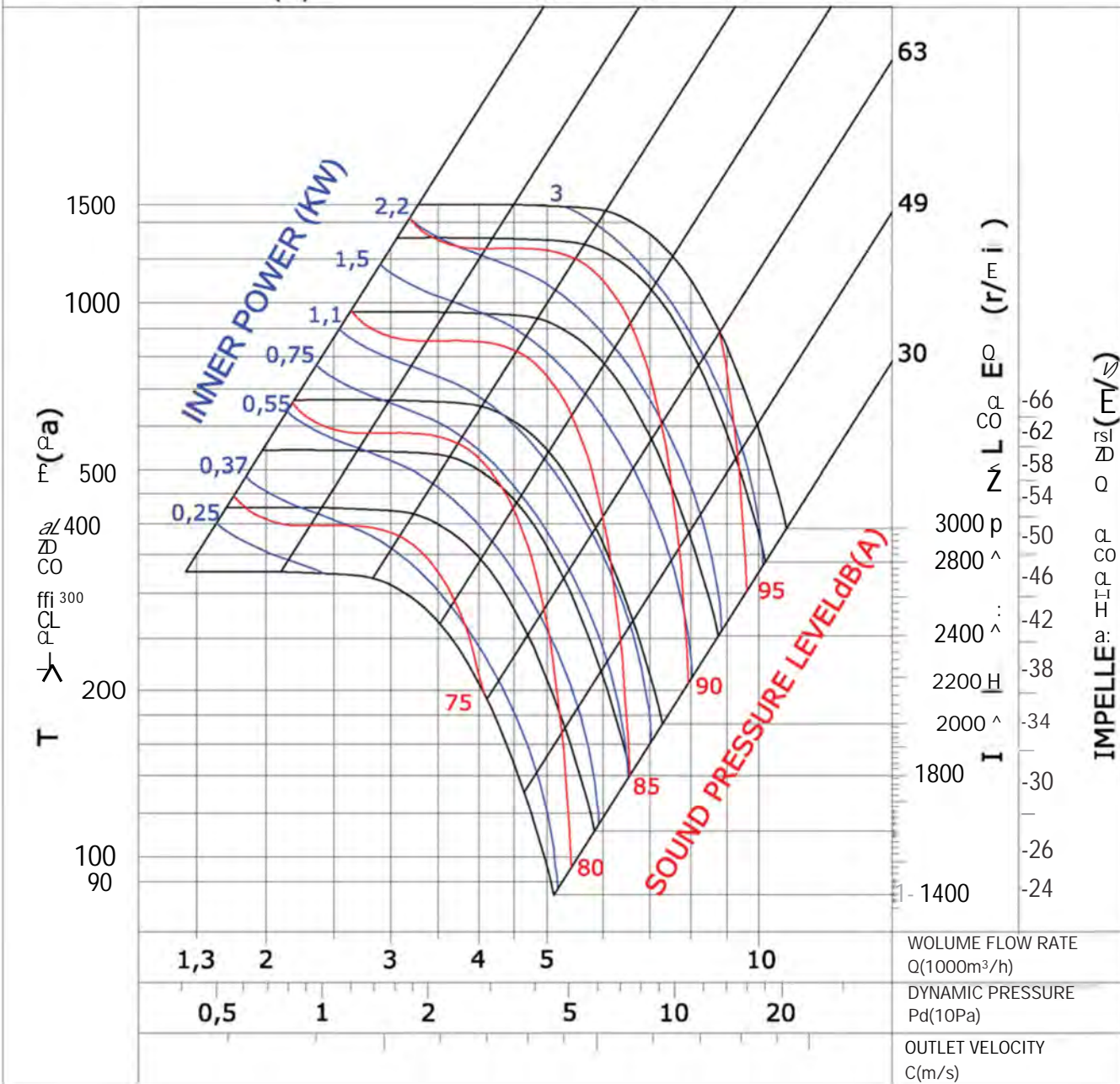

# BHV-R 355

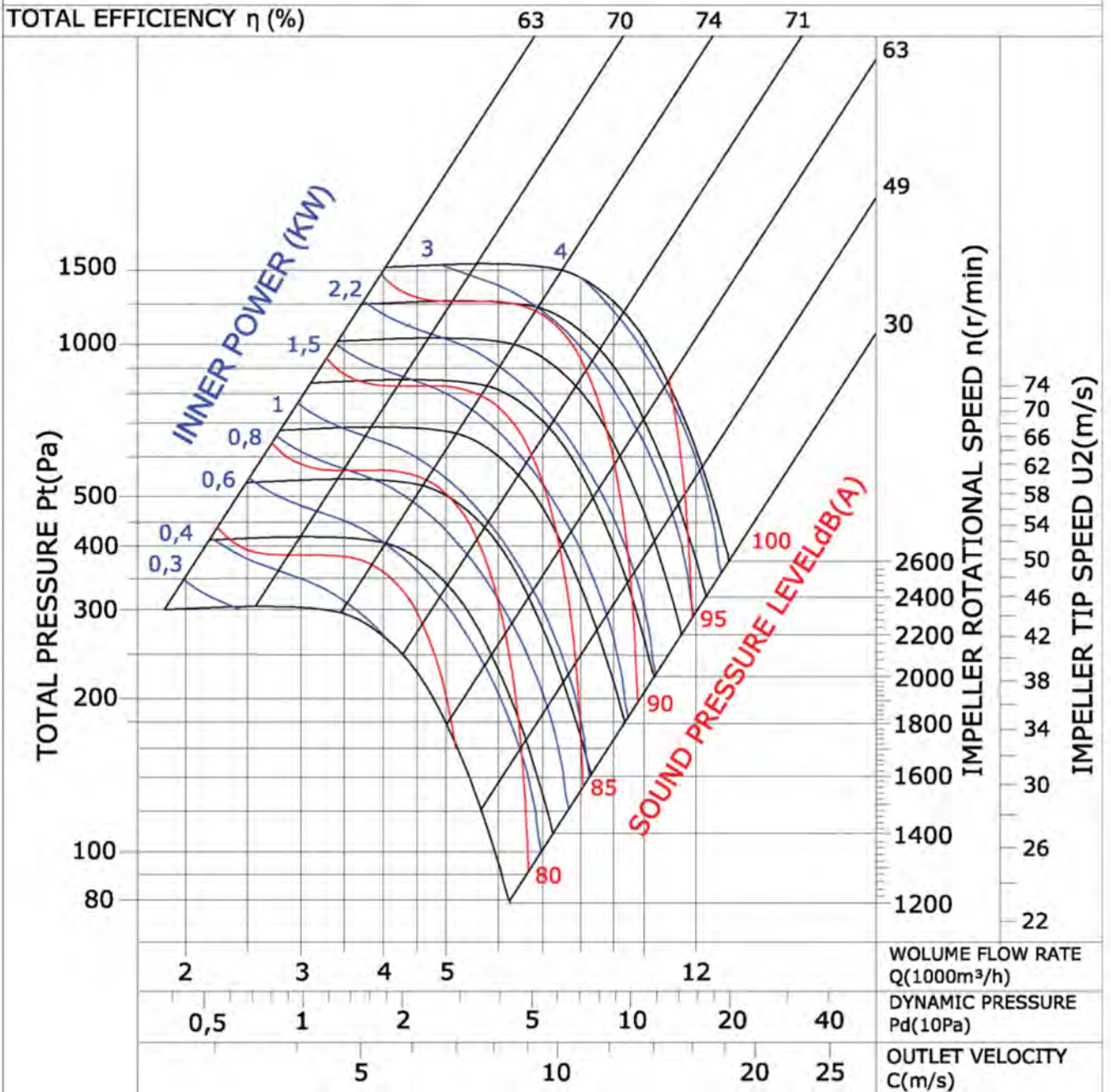



# BHV-R 400

TOTAL EFFICIENCY  $\eta_t$  (%)

66 71 75 74 69

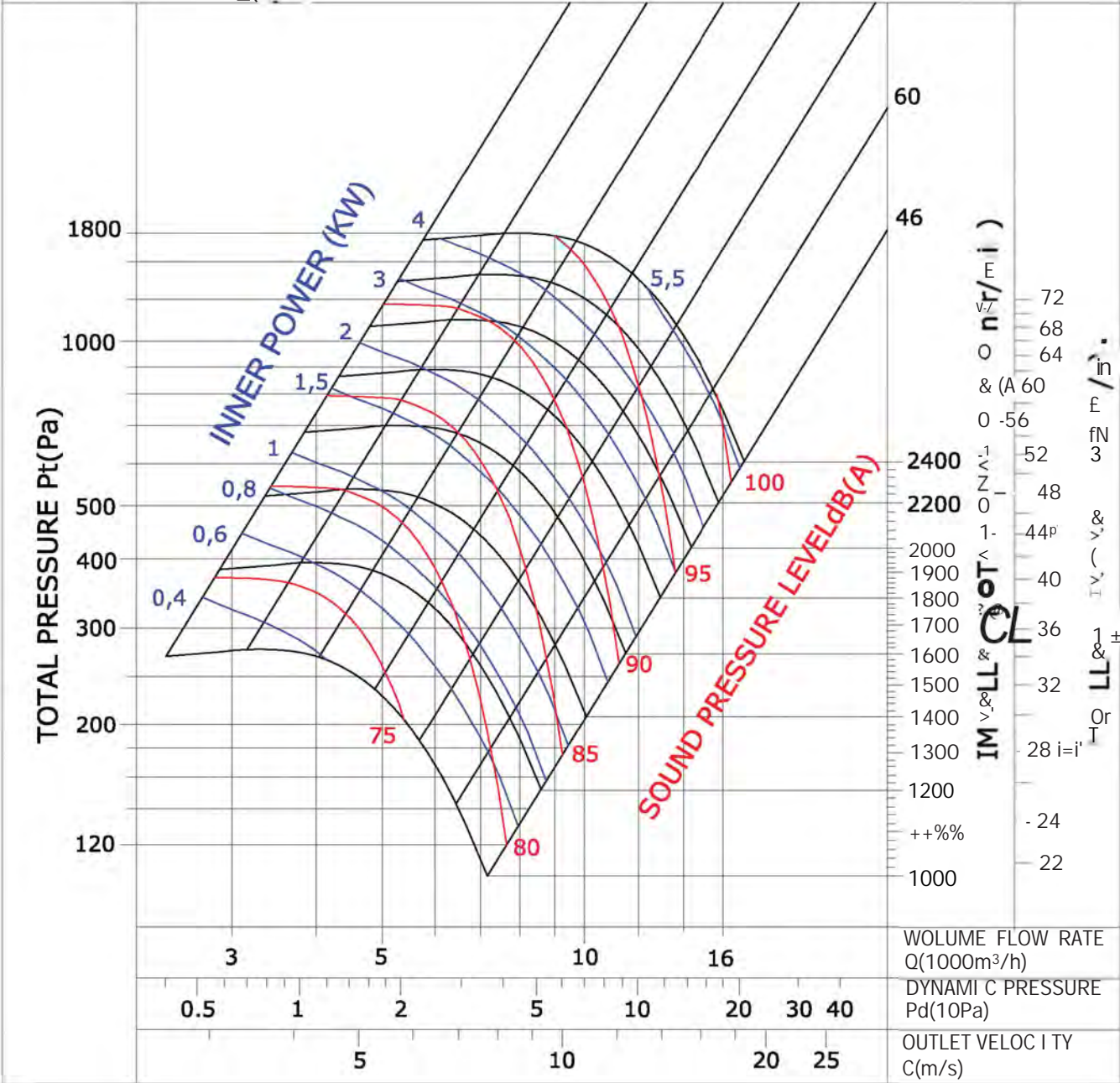



# BHV-R 450

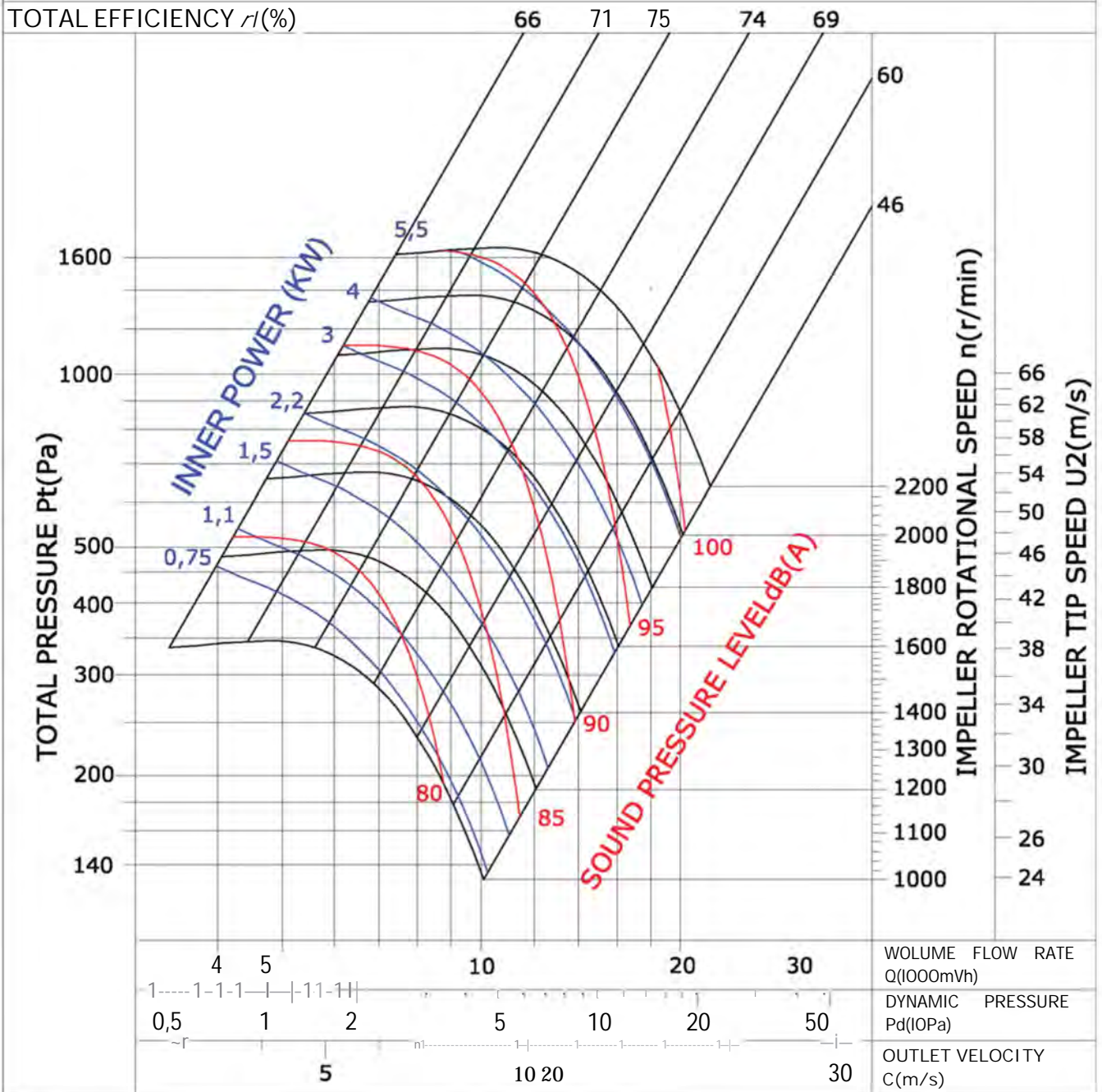



# BHV-R 500

TOTAL EFFICIENCY  $\eta$  (%)

67 72 76 74 70

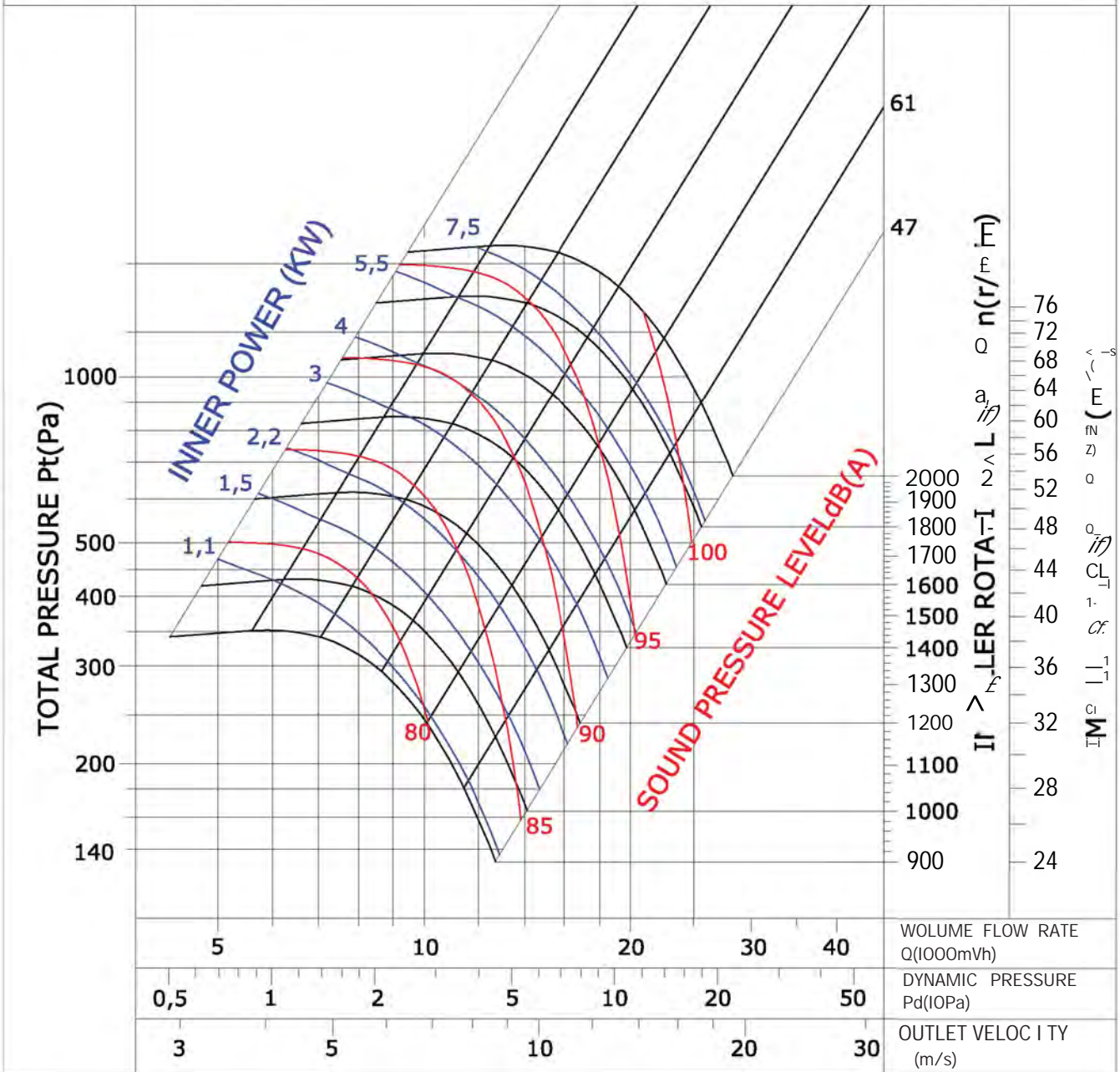

# BHV-R 560

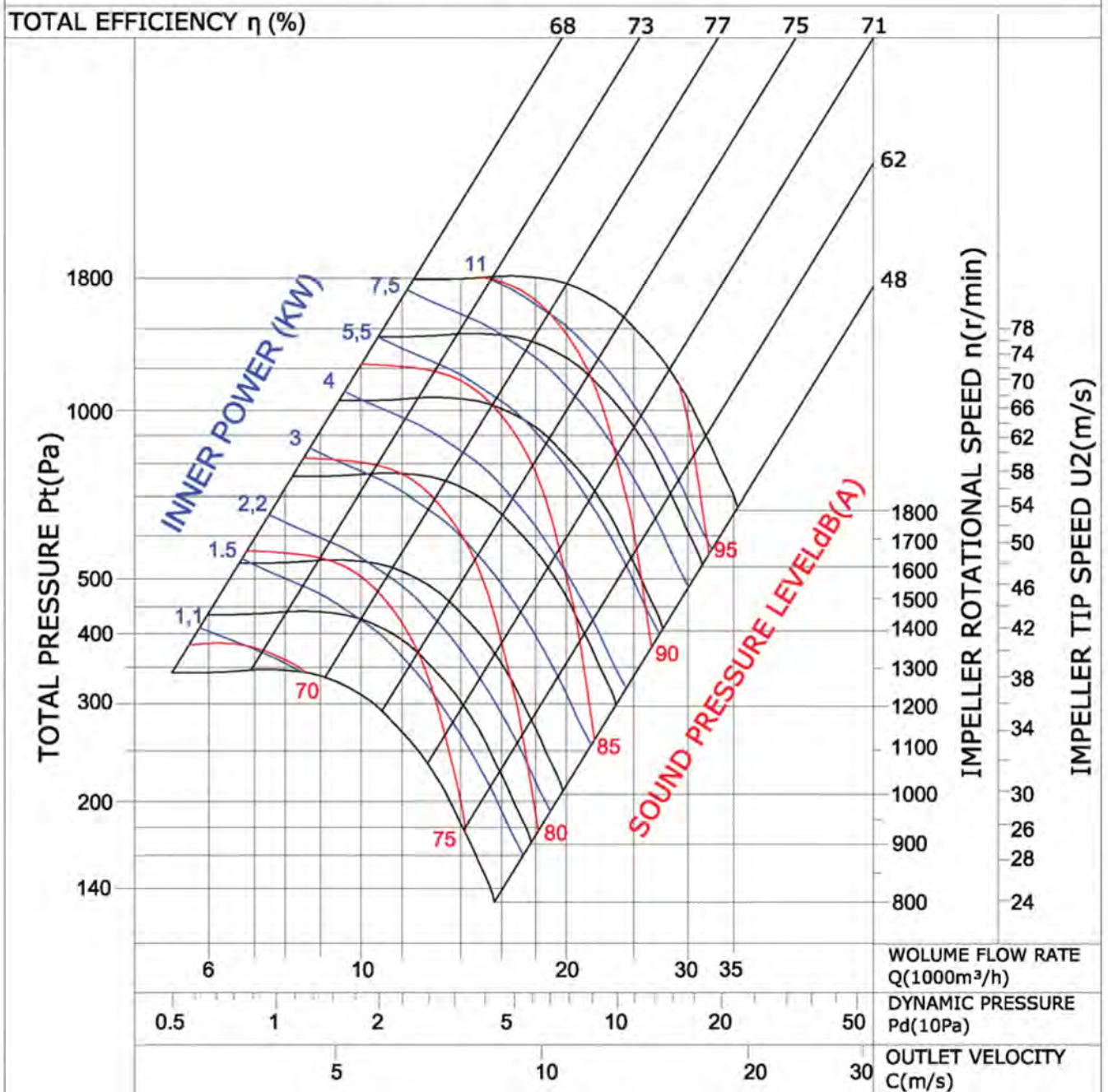

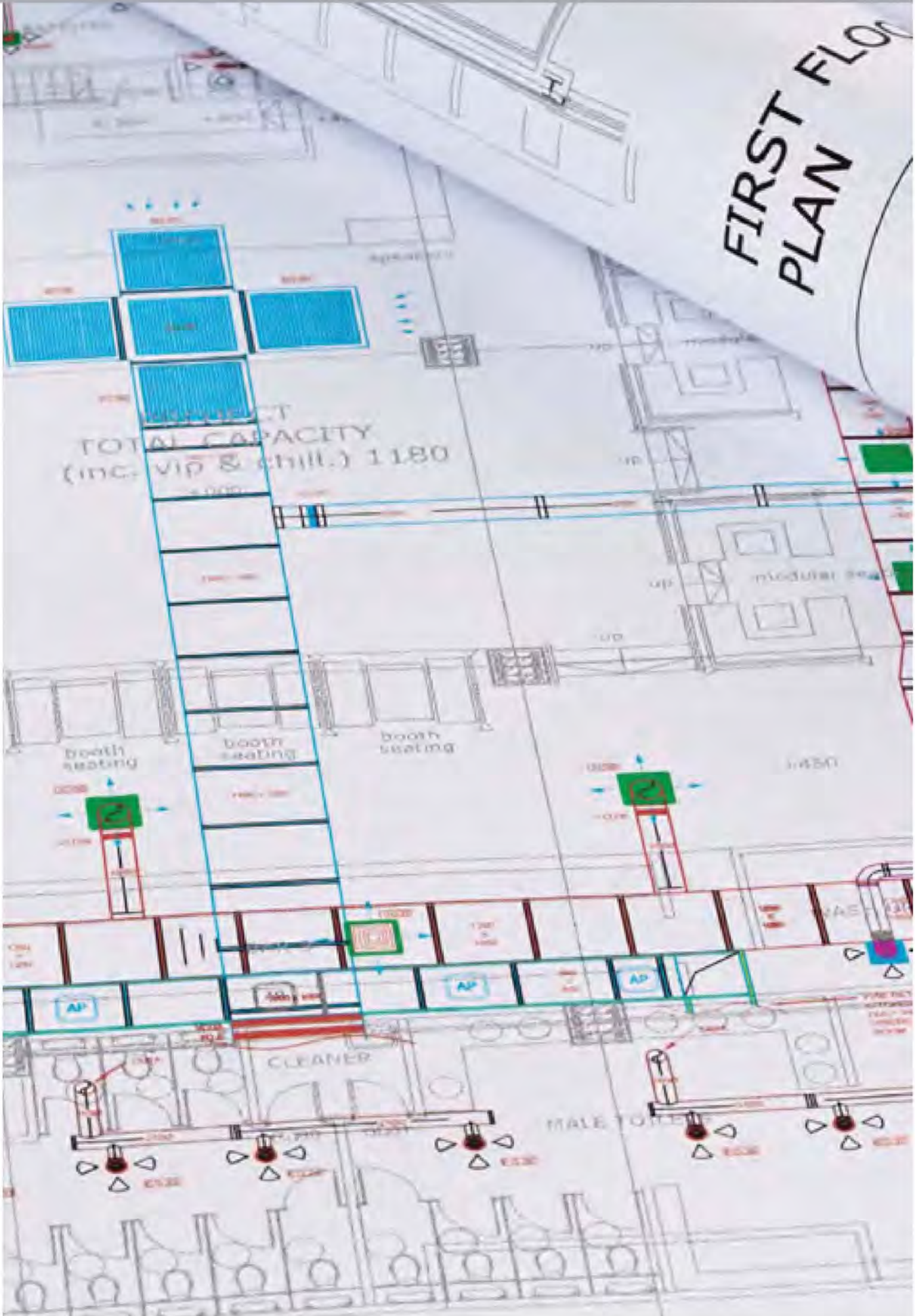

- DUCT FANS
- Roof FA
- ASHA-FA
- 4/L FA
- FOOT FA
- VENTILAT
- DUCT SYSTEMS
- AC ESSO ES



# ROOFFANS

BRF

BRCF

BRCF-M

BRF-V

BRDV

BACF

## ROOF FANS



# BRF

## AC CENTRIFUGAL ROOF FANS Horizontal Outlet

For increasing indoor air quality, BRF roof fans work silently with their external rotor motors. The unit works trouble-free on the highest performance.

### Technical Drawings

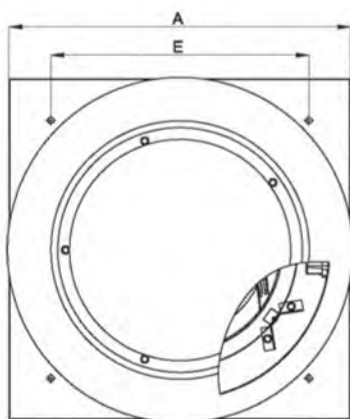
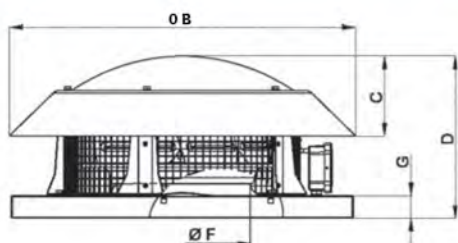

#### MATERIAL

: The housing is made of electrostatic powder coated sheet iron, backward impeller is made of galvanized sheet metal,

#### INSULATION CLASS

: Class B or Class F

#### DIRECTIVE

: EN 60335-1, EN 60335-2-80

#### SPEED CONTROL

: Speed can be adjusted using an optional controller,

#### APPLICATION AREAS

: For industrial and constructional applications, in factories, hospitals, night clubs, offices, kitchens, bathrooms, theaters, condominiums, restaurants, etc,

TYPE	A			D	E	F	G
BRF 160	252	260	50	140	210	80	25
BRF 180	252	260	50	140	210	80	25
BRF 225	336	386	105	212	274	146	35
BRF 250	370	386	105	225	290	163	35
BRF315	454	443	135	293	333	185	40
BRF 355	595	595	135	285	450	234	40
BRF 400	595	685	145	355	450	270	40
BRF 450	664	685	145	400	450	282	40
BRF 500	798	824	155	385	600	320	40
BRF 560	798	824	155	400	600	360	40

Dimensions are in (mm)

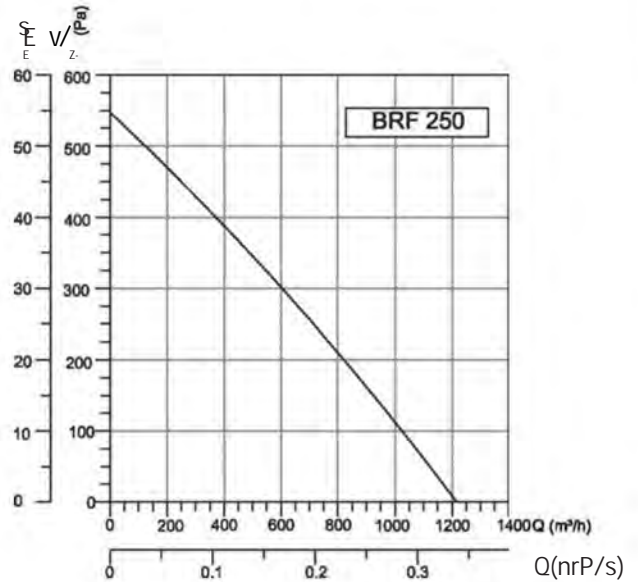
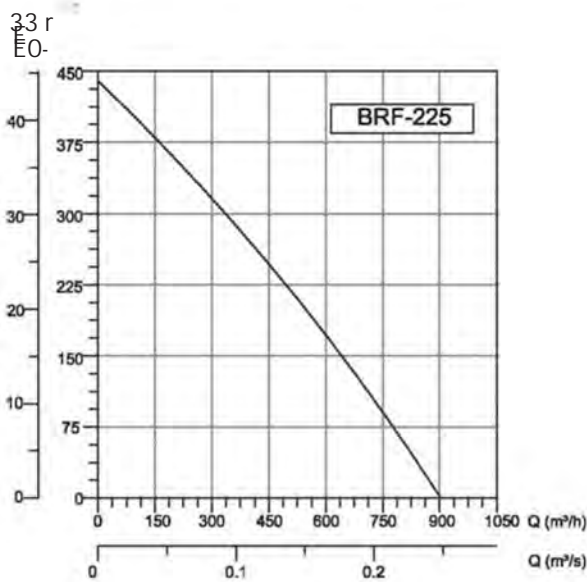
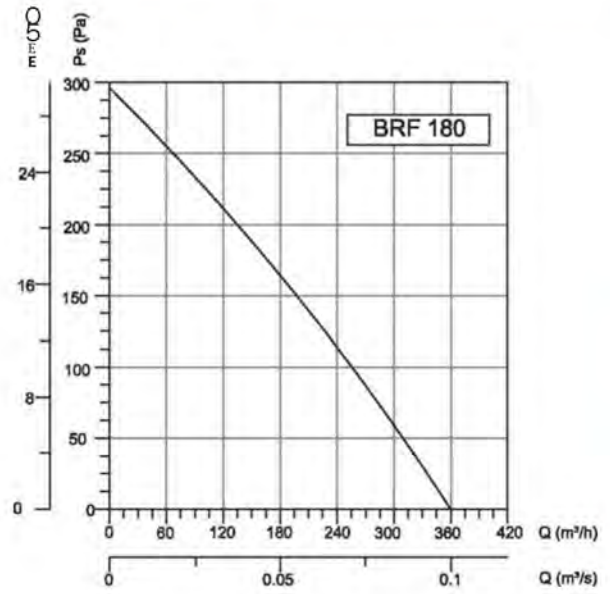
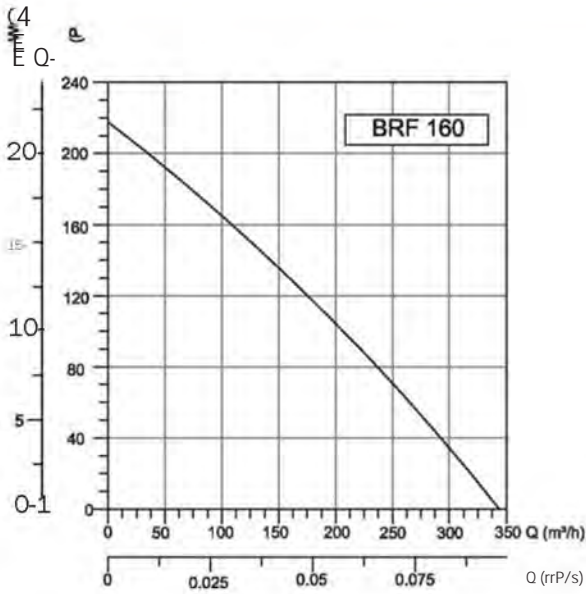

TYPE	V	Hz	w	(A)	(MF)	d/d	m³/h	O/ES dB(A)	kg
BRF160	230	50	65	0,3	2	2547	346	46	3,5
BRF180	230	50	80	0,35	2,5	2500	360	50	3,7
BRF 225	230	50	130	0,6	5	2640	902	54	7
BRF 250	230	50	120	0,8	6	2685	1212	55	8
BRF315	230	50	180	0,6	6	1400	1500	56	12,8
BRF355	230	50	220	1	6	1400	2400	65	18
BRF 400	230	50	345	1,5	12	1400	3500	68	22
BRF 450	230	50	620	2,8	18	1400	5000	72	28
BRF 500	380	50	950	2,4	-	1400	7550	72	45,5
BRF 560	380	50	1550	2,8	-	1400	9600	80	48

ROOF FANS  
 ACCESSORIES  
 EN

# ROOF FANS

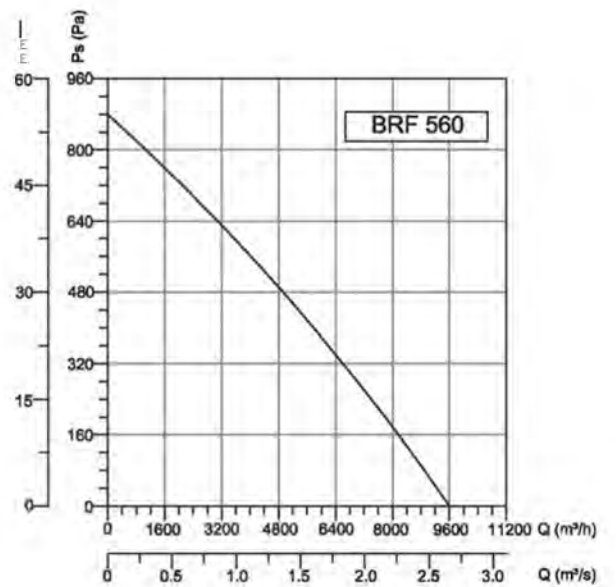
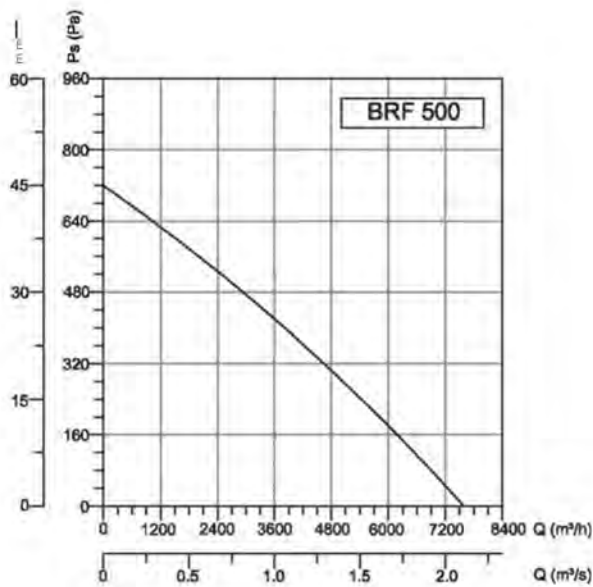
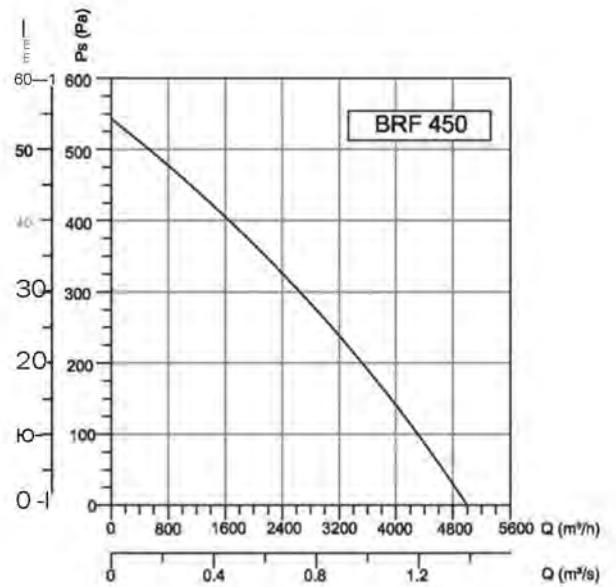
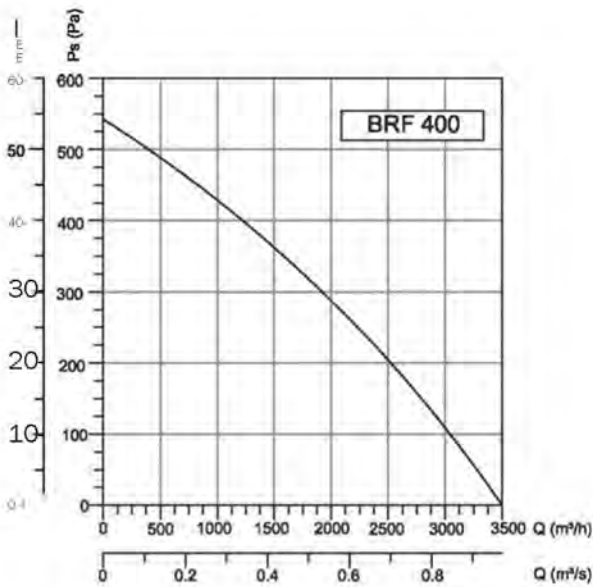
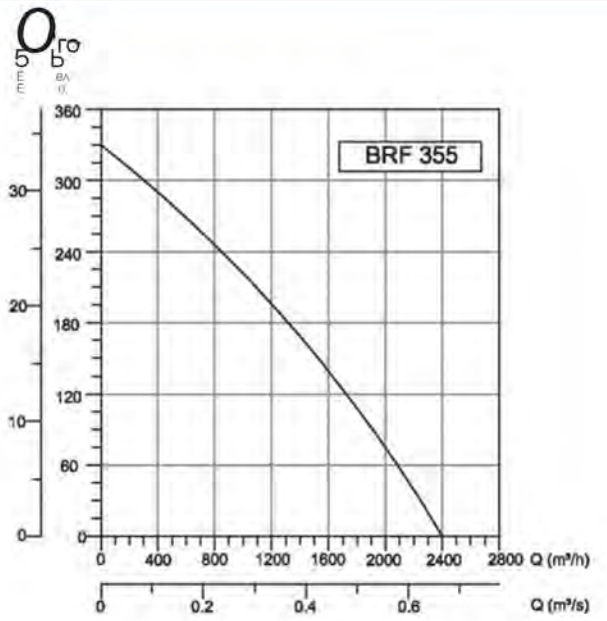
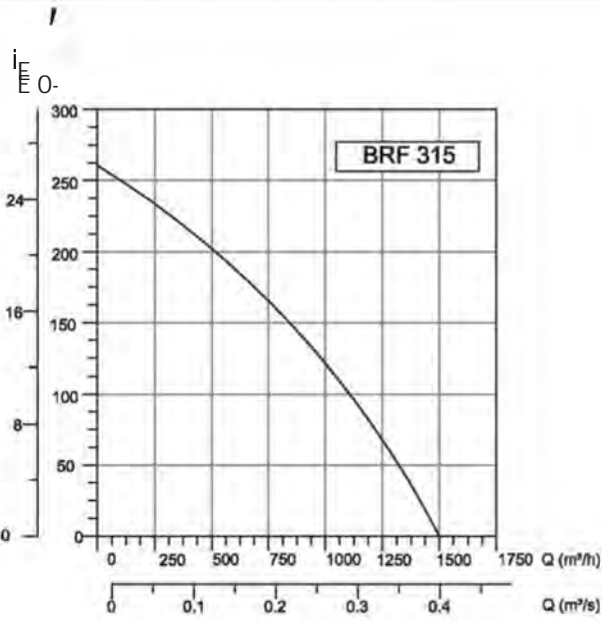



### Accessories



BSC



BSC-F

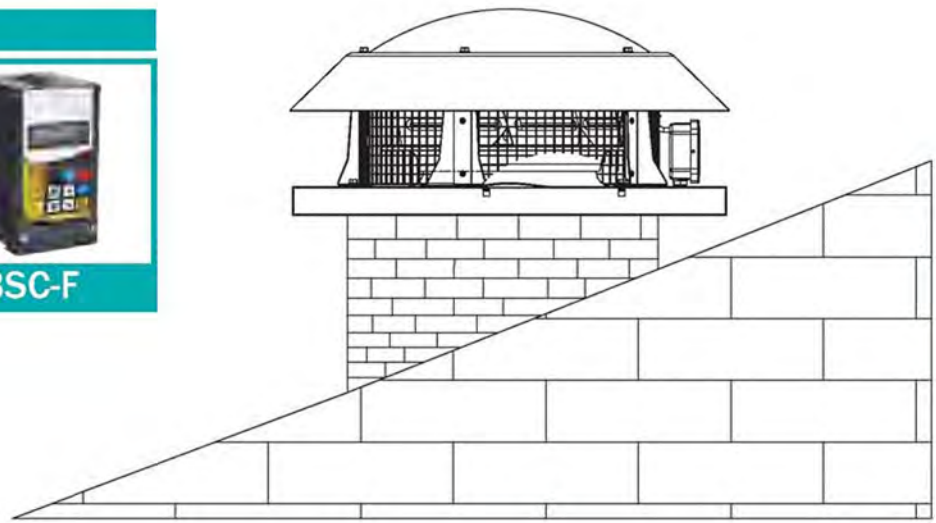

# ROOF FANS

# BRCF

AC DIRECT DRIVE ROOF FANS

Horizontal Outlet

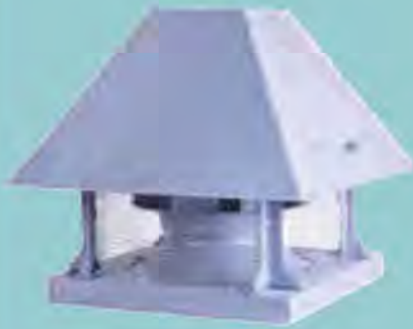

BRCF is used as a smoke exhaust fan in industrial and residential areas to vent out the hot gases through chimney, Max, transferred air temperature is 120°C,

## Technical Drawings

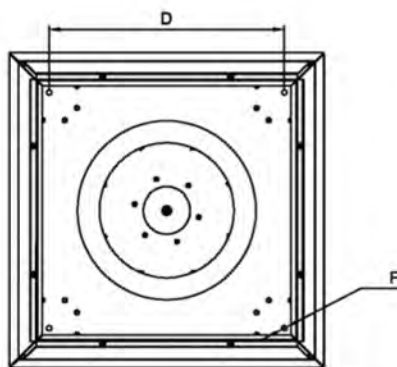
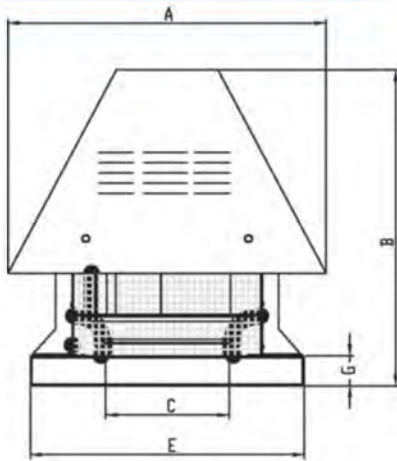

MATERIAL

: The housing is made of electrostatic powder coated sheet steel, fan is made of sheet steel with backward curved impeller and welded execution,

INSULATION CLASS

: Class F

MAX. AIR TEMPERATURE

: 120°C

DIRECTIVE

: EN 60335-1, EN 60335-2-80

SPEED CONTROL

: Speed can be adjusted using an optional controller

APPLICATION AREAS

: Fan series is perfect to use in residential, commercial and industrial environments, especially where hot air and smoke is needed to be transferred, For example cafes, restaurants, gymnasiums, shopping centers, hospitals, factories, offices etc,

## Accessories



BSC-F

TYPE	A			D	E	F	G
BRCF 280	524	505	165	354	404	10	44
BRCF315	593	546	185	404	454	10	44
BRCF355	655	546	234	450	500	10	44
BRCF 400	655	574	270	450	500	12	44
BRCF 450	730	568	282	530	580	12	44
BRCF 500	800	665	320	590	640	12	44
BRCF 560	856	723	360	650	700	12	44
BRCF 630	986	888	448	660	730	12	54
BRCF 710	1080	958	450	710	780	12	54
BRCF800	1190	1130	542	850	900	12	54

Dimensions are in (mm)

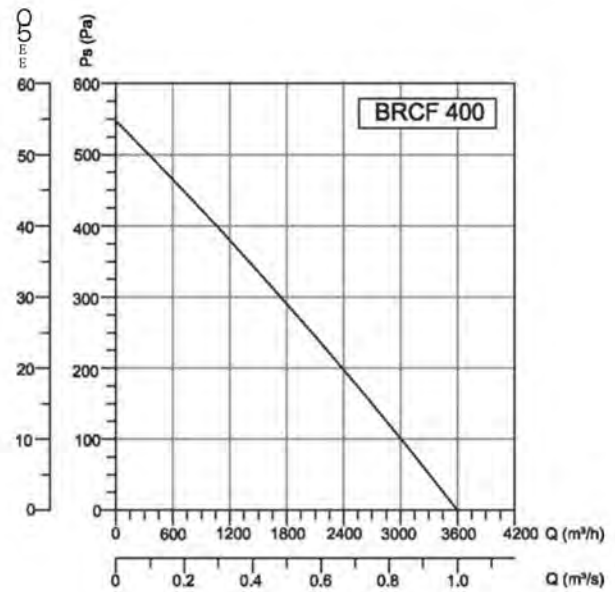
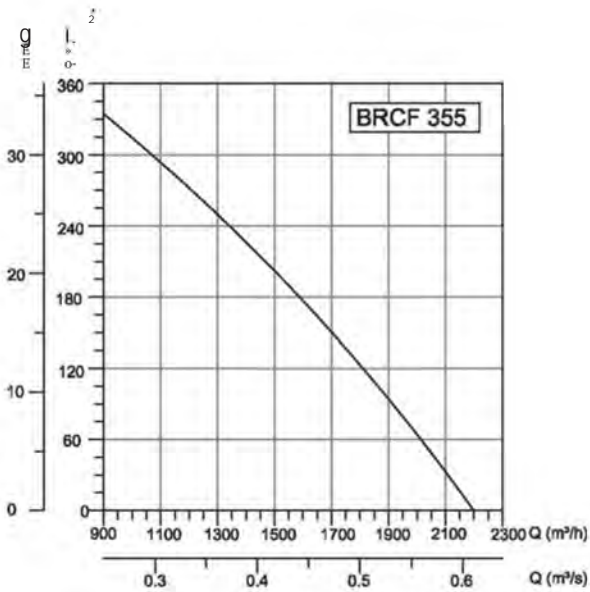
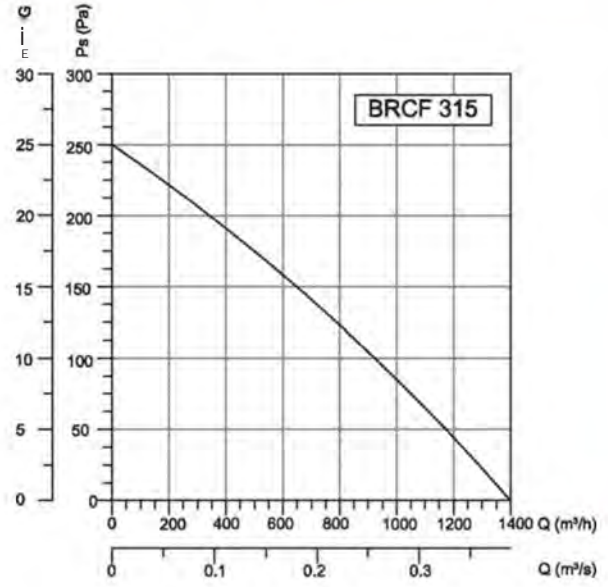
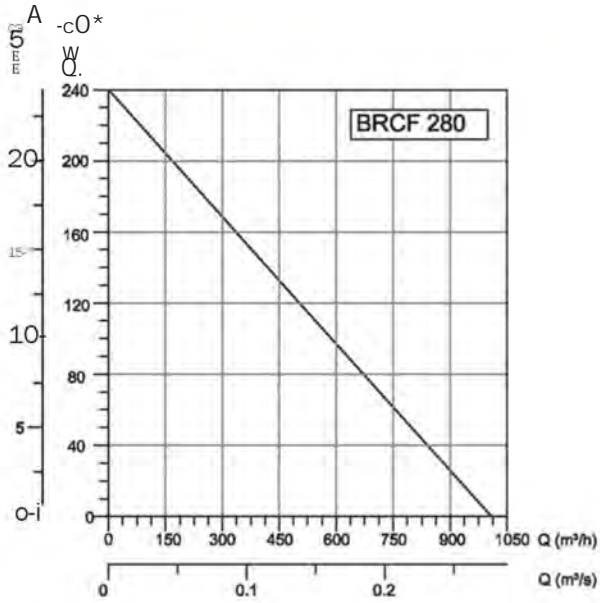

TYPE	SIZE	FREQUENCY	POWER	CURRENT	SPEED	AIR FLOW	SOUND PRESSURE LEVEL	WEIGHT
	V							
BRCF280M / BRCF280T	230/380	50	0,37	2,6/1,15	1400	1000	42	35
BRCF315M / BRCF315T	230/380	50	0,37	2,6/1,15	1400	1415	44	42
BRCF355M / BRCF 355T	230/380	50	0,37	2,6/1,15	1400	2200	45	50
BRCF 400M / BRCF 400T	230/380	50	0,55	3,3/1,5	1400	3600	48	55
BRCF 450M / BRCF 450T	230/380	50	0,75	4,6/2	1400	4400	55	62
BRCF 500M / BRCF 500T	230/380	50	1	7,1/2,6	1400	8500	60	68
BRCF 560M / BRCF 560T	230/380	50	1,5	9,3/3,5	1400	10000	65	75
BRCF 630T	380	50	3	6,45	1000	11200	80	127
BRCF 710T	380	50	4	8,2	1000	12800	83	150
BRCF 800T	380	50	7,5	15,3	1000	16000	85	216

# ROOF FANS

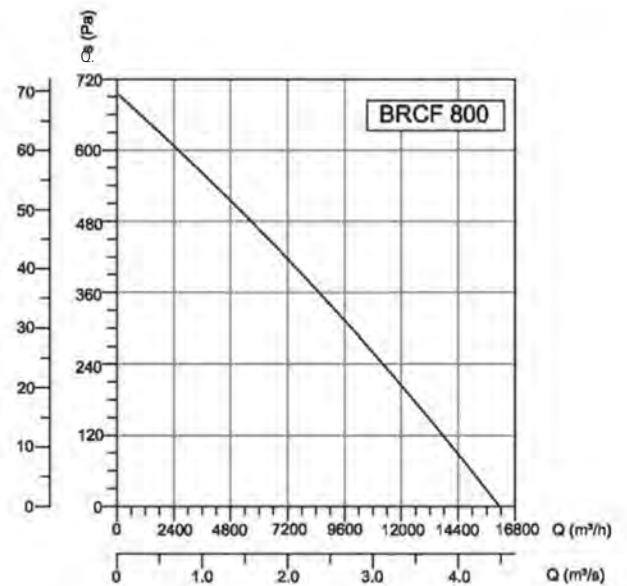
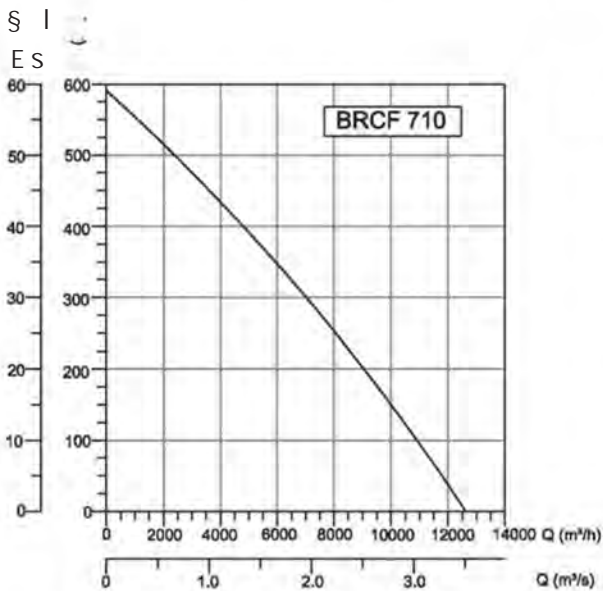
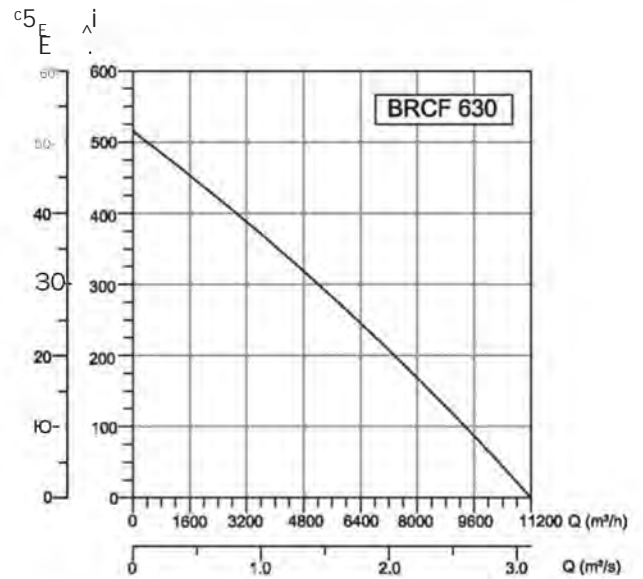
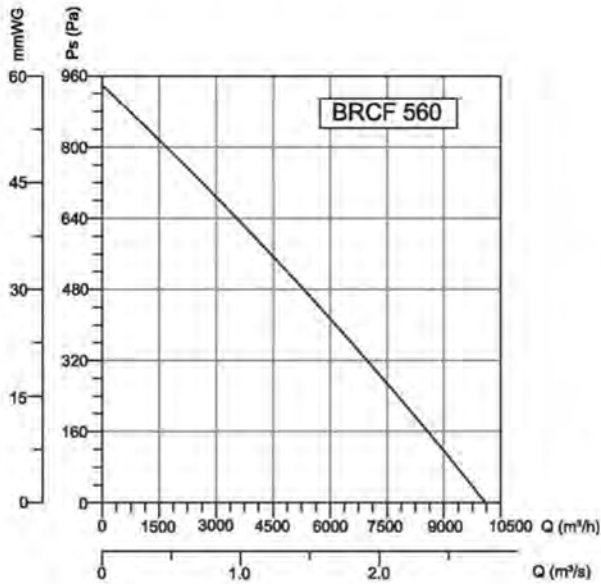
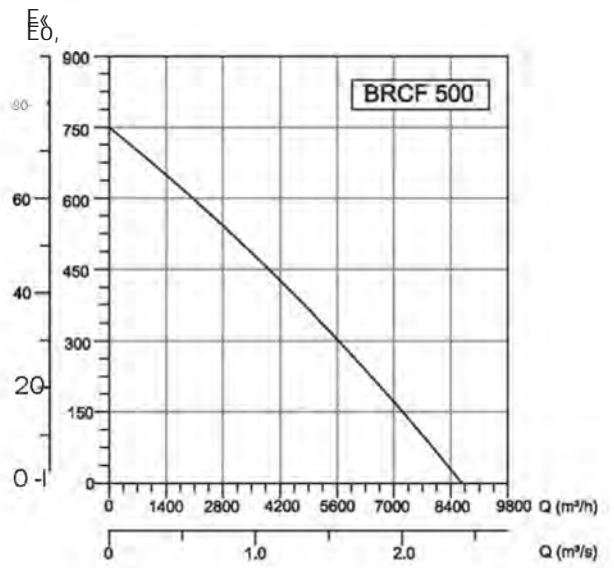
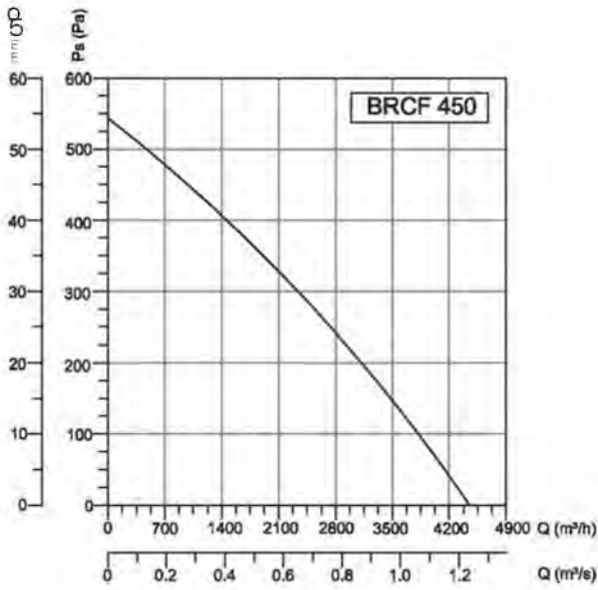



DUCT FANS

**ROOF FANS**

AXIAL FANS

RADIAL FANS

PLASTIC FANS

VENTILATORS

SMOKE EXHAUST SYSTEMS

ACCESSORIES

## ROOF FANS

# BRCF-M

## AC DIRECT DRIVE ROOF FANS Horizontal Outlet



BRCF-M is used as a smoke exhaust fan in industrial and residential areas to vent out the hot gases through chimney. Max. transferred air temperature is 120°C.

- MATERIAL** : The housing is made of electrostatic powder coated sheet iron, backward impeller is made of galvanized sheet metal,
- INSULATION CLASS : Class F
- MAX. AIR TEMPERATURE: 120°C
- DIRECTIVE : EN 60335-1, EN 60335-2-80
- SPEED CONTROL : Speed can be adjusted using an optional controller,
- APPLICATION AREAS : Fan series is perfect to use in residential, commercial and industrial environments, especially where hot air and smoke is needed to be transferred, For example cafes, restaurants, gymnasiums, shopping centers, hospitals, factories, offices etc,

### Technical Drawings

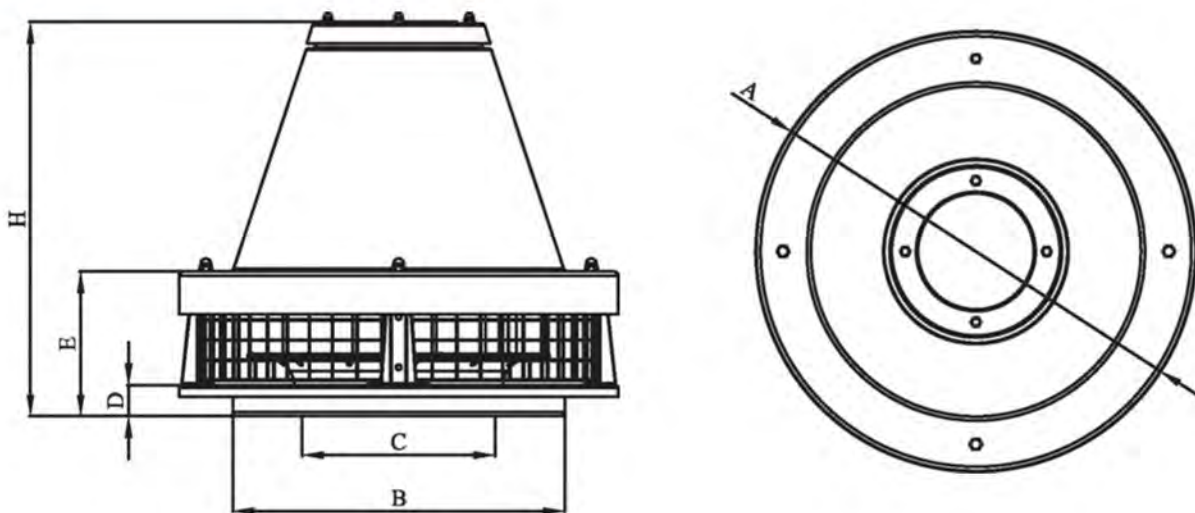

TYPE	A			D	E	H
BRCF-M 315	410	310	180	30	156	391

Dimensions are in (mm)

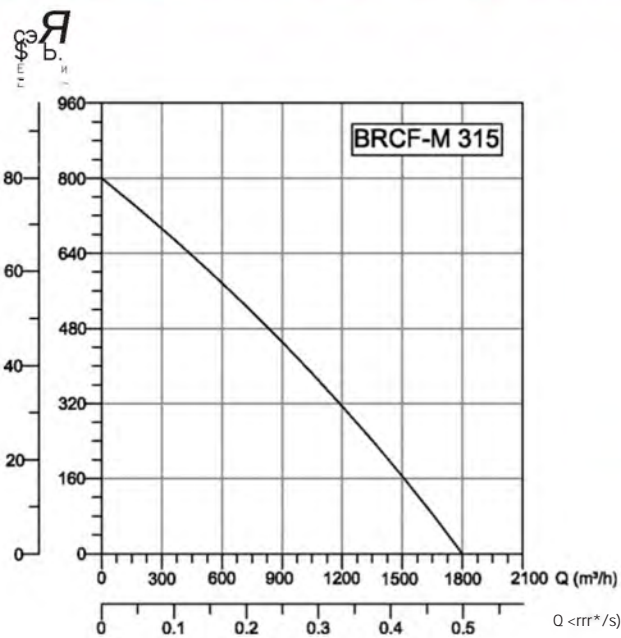

### Accessories



**BSC**

TYPE	VOLTAGE	FREQUENCY	$\rho$	CURRENT	CAPACITOR	SPEED	AIR FLOW	SOUND PRESSURE LEVEL	WEIGHT
	V	Hz	W	(A)	(MF)	d/d	m³/h	dB(A)	kg
BRCF-M 315	220	50	250	1,2	8	2900	1800	60	11,3

# ROOF FANS

## BRF-V

AC CENTRIFUGAL ROOF FANS

Vertical Outlet



Roof Mounted Fans are perfect solution for ventilation needs where "polluted air exhaust" is at a premium, BRF-V roof fans are perfect for the places where air can not be ventilated horizontally, Rain drops are vented out by venting holes to prevent them get inside the chimney,

### Technical Drawings

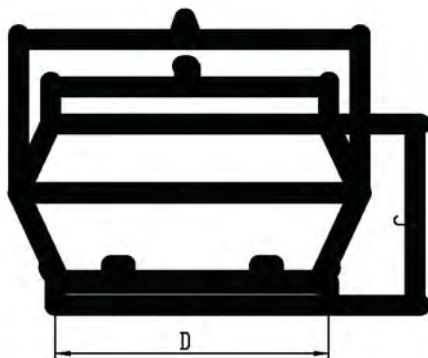
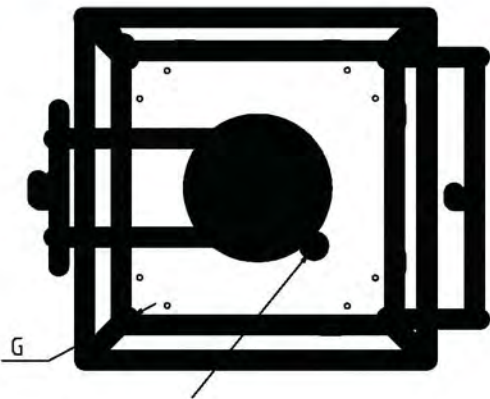

- MATERIAL : The housing is made of galvanized sheet, backward curved impeller is made of also galvanized sheet metal,
- INSULATION CLASS : Class G or Class F
- DIRECTIVE : EN 60335-1, EN 60335-2-80
- SPEED CONTROL : Speed can be adjusted using an optional controller,
- APPLICATION AREAS : For industrial and constructional applications, in factories, hospitals, nightclubs, offices, kitchens, bathrooms, theaters, condominiums, restaurants, etc,



TYPE	A			D	E	F	G
BRF-V 225	350	295	190	335	146	245	10
BRF-V 315	552	450	330	505	185	450	10
BRF-V 355	745	607	385	595	234	450	10
BRF-V 400	745	607	385	595	270	450	10
BRF-V 450	900	742	512	665	282	630	10
BRF-V 500	900	742	512	665	320	630	12
BRF-V 560	1190	955	595	946	360	740	12

Dimensions are in (mm)



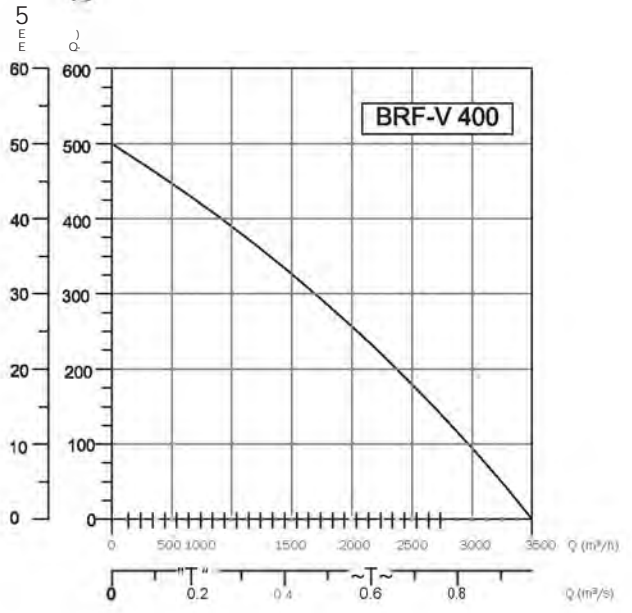
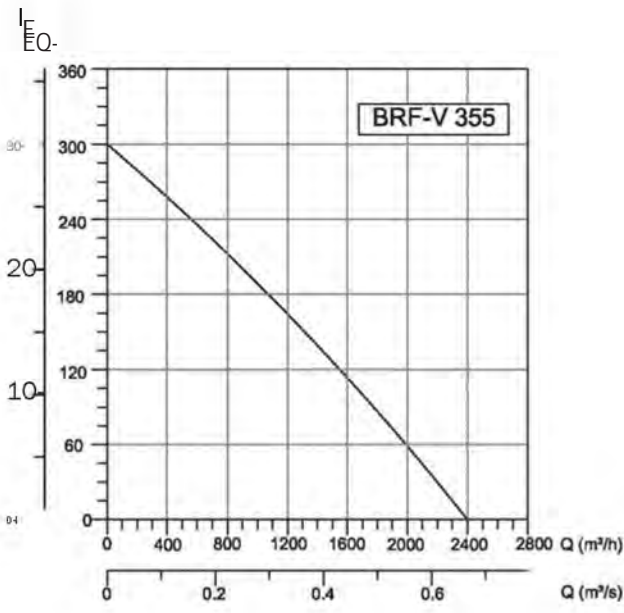
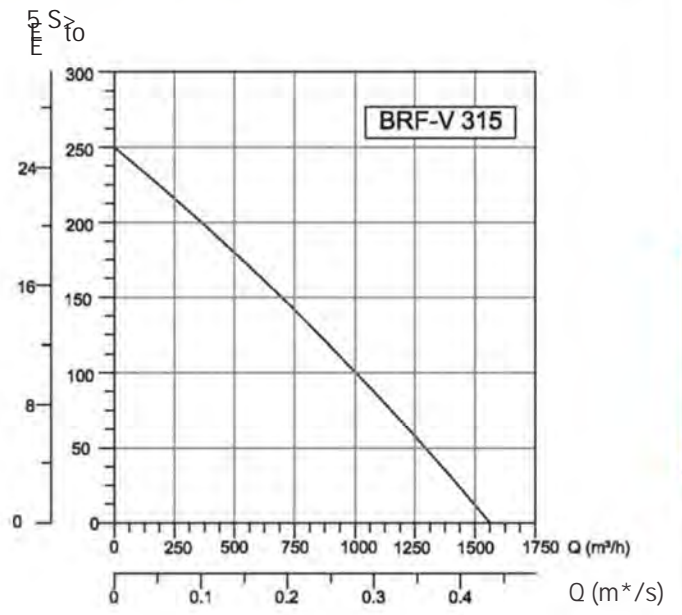
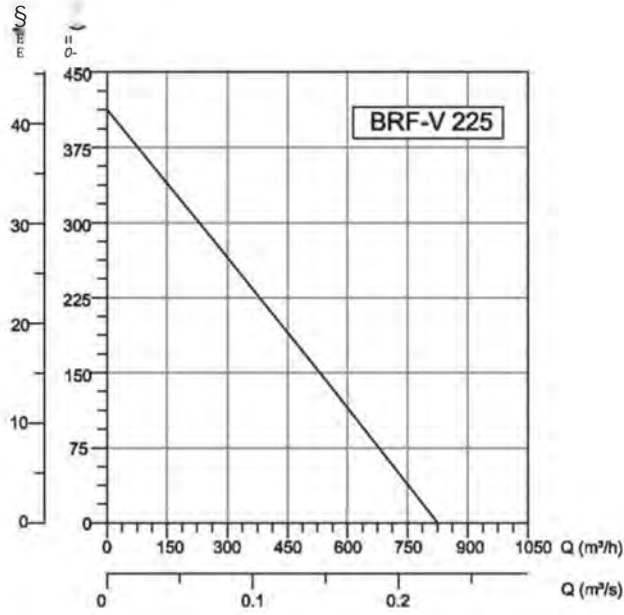

TYPE	V	FREQUENCY Hz	ac b, w	CURRENT (A)	DC 8 I (MF)	Ø <sub>1</sub> d/d	Q <sub>DC</sub> m³/h	S <sub>1</sub> * vfa-J dB(A)	WEIGHT kg
BRF-V 225	230	50	130	0,6	5	2640	850	40	7
BRF-V315	230	50	180	0,5	4	1430	1550	54	22
BRF-V 355	230	50	220	1	6	1400	2400	56	34
BRF-V 400	230	50	360	1,5	12	1420	3500	59	39
BRF-V 450	230	50	620	2,2	18	1410	5000	60	51
BRF-V 500	380	50	950	2,4	-	1400	7550	62	60
BRF-V 560	380	50	1550	3,1	-	1380	9600	75	99

# ROOF FANS

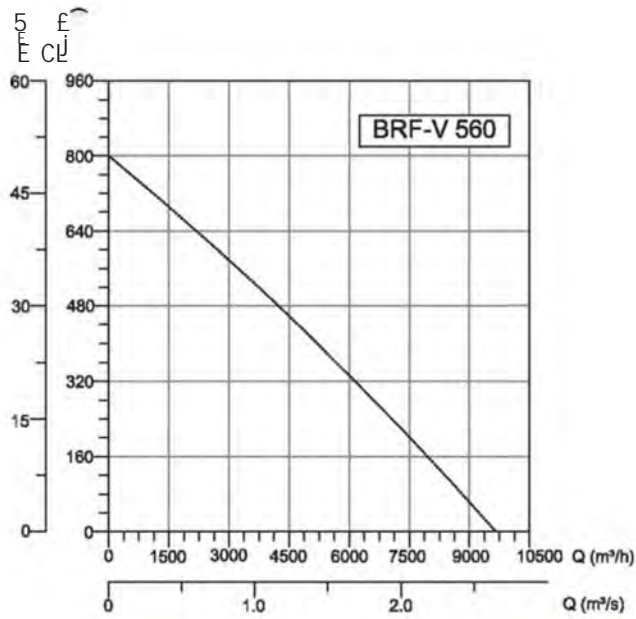
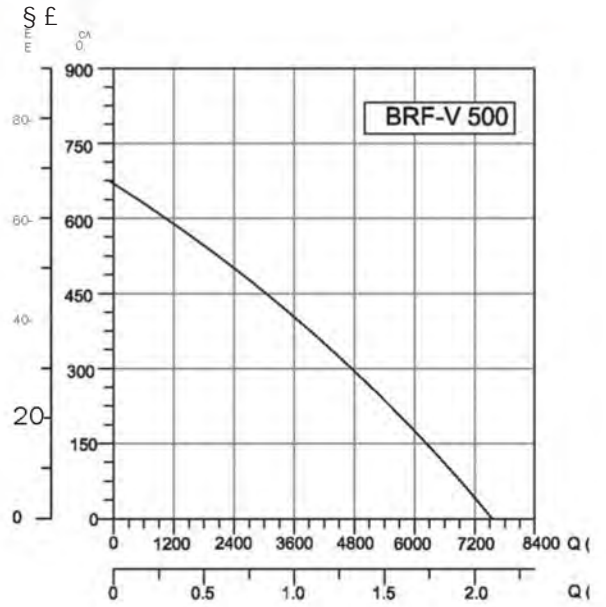
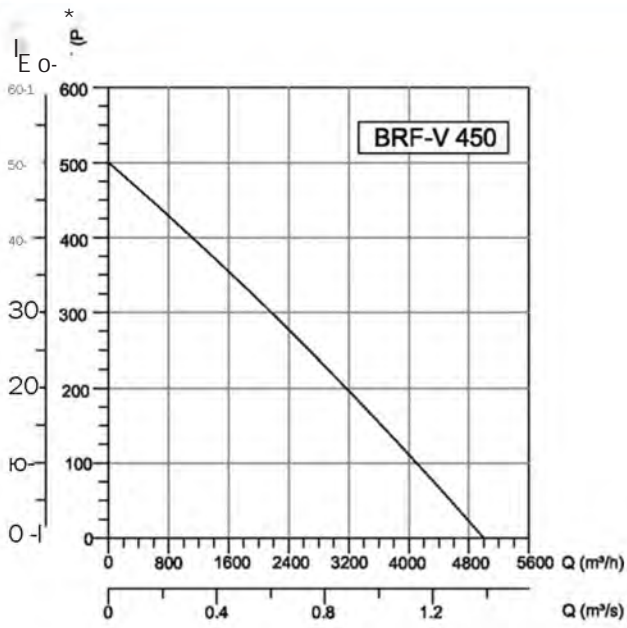



# ROOF FANS

## BRDV

### AC DIRECT DRIVE ROOF FANS Vertical Outlet



Backward curved and direct coupled motors are used in BRDV vertical outlet radial roof fans. Max. Transferred air temperature is 120°C. Low noise level.

#### Technical Drawings

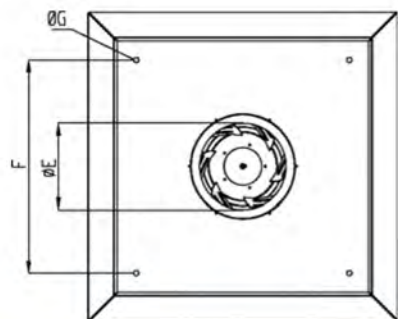
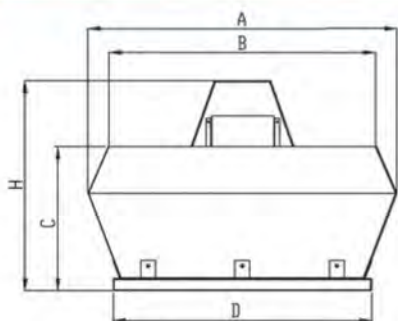

- MATERIAL : The housing is made of galvanized sheet iron, backward curved impeller is made of galvanized sheet metal.
- INSULATION CLASS : Class F
- MAX. AIR TEMPERATURE : 120°C
- DIRECTIVE : EN 60335-1, EN 60335-2-80
- SPEED CONTROL : Speed can be adjusted using an optional controller.
- APPLICATION AREAS : The BRDV fan series is perfect to use in residential, commercial and industrial environments, especially where hot air and smoke is needed to be transferred.

#### Accessories



BSC-F

TYPE	VOLTAGE V	FREQUENCY Hz	POWER IW	H# B (A)	CAPACITOR (MF)	SPEED d/d	AIR FLOW m/h	SOUND PRESSURE LEVEL dB(A)	WEIGHT kg
BRDV 315	230/380	50	0,25	1,8/0,81	10/-	1420	1700	47	22
BRDV 355	230/380	50	0,37	2,6/1,15	12/-	1410	2500	49	27
BRDV 400	230/380	50	0,37	2,6/1,15	12/-	1400	3600	52	33
BRDV 450	380	50	0,75	2	-	1370	5000	54	38
BRDV 500	380	50	1,5	3,5	-	1350	8000	57	49
BRDV 560	380	50	2,2	5,1	-	1350	10500	65	58

TYPE	A			D	E	F	G	H
BRDV 315	840	730	390	700	185	576	14	575
BRDV 355	840	730	390	700	234	576	14	575
BRDV 400	890	785	425	750	270	576	14	596
BRDV 450	960	850	445	800	282	626	14	655
BRDV 500	1030	910	490	850	320	676	14	720
BRDV 560	1190	960	600	950	360	740	14	850

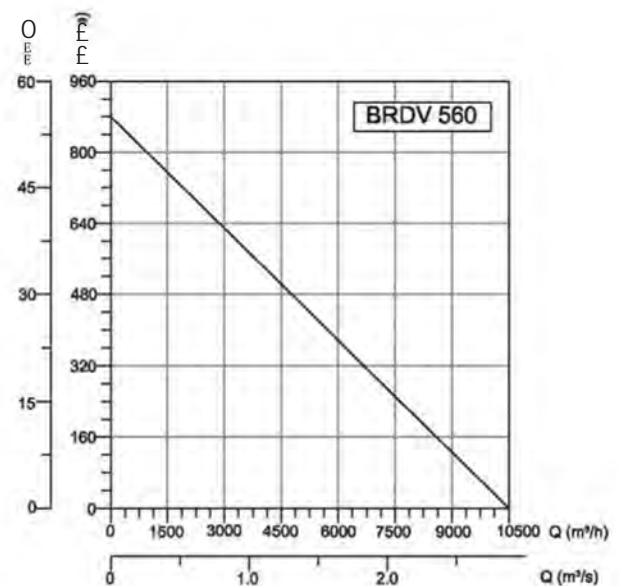
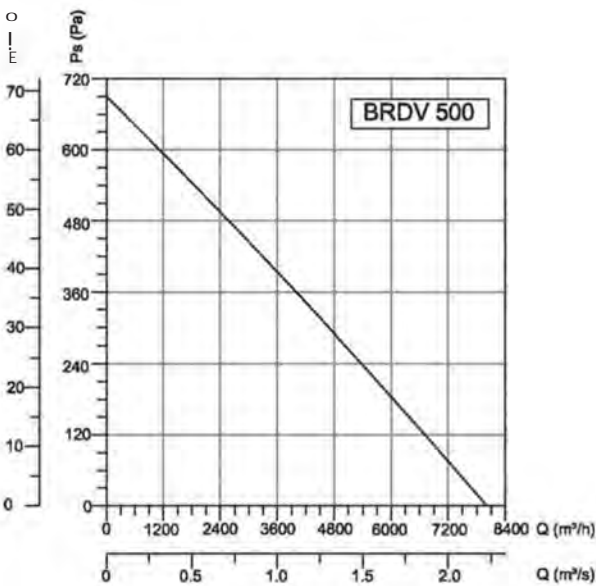
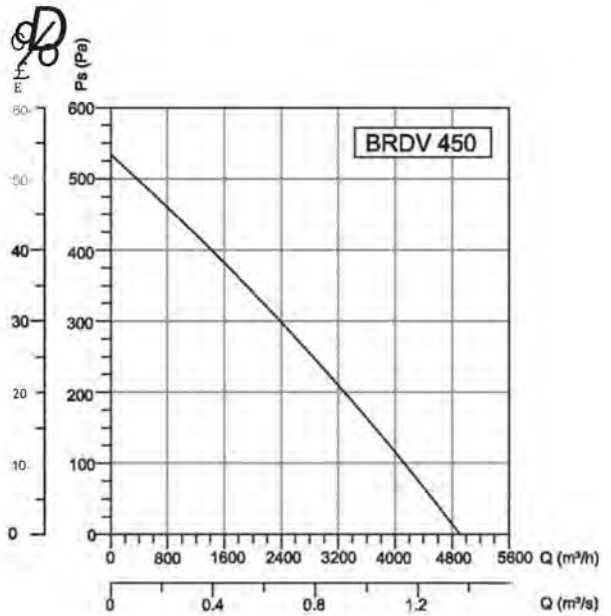
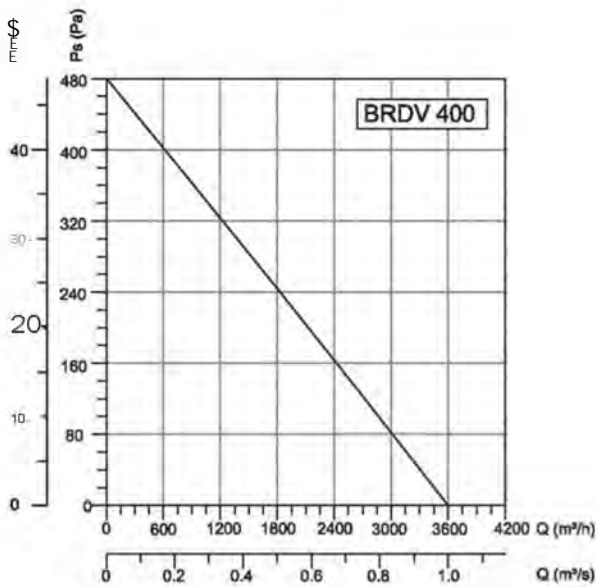
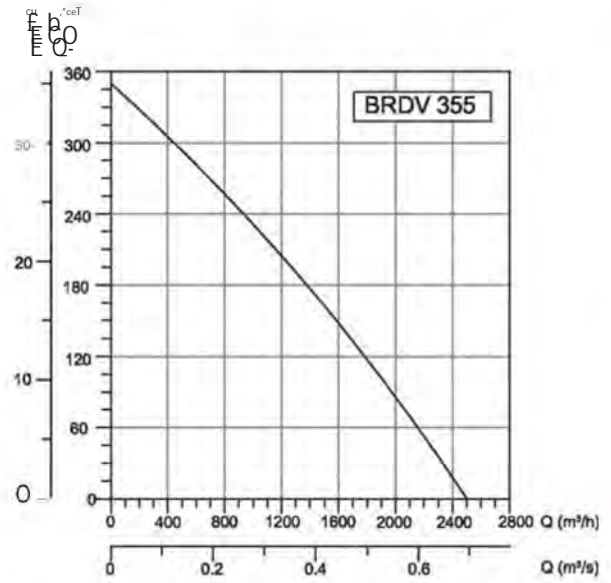
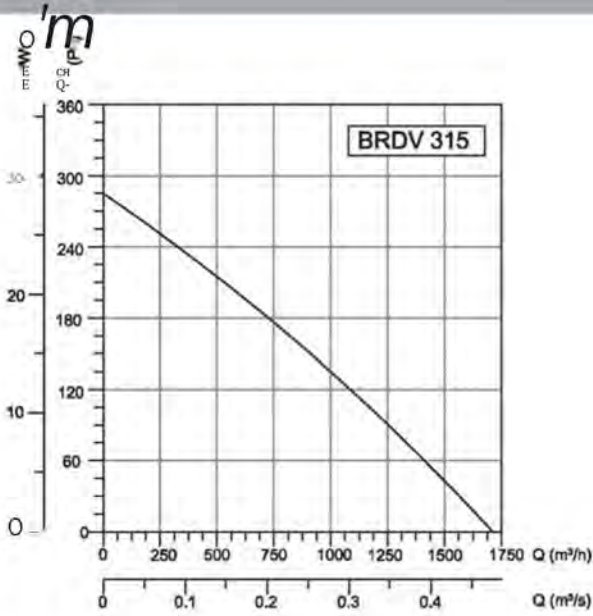

# ROOF FANS



## BACF

### AC AXIAL ROOF FANS Horizontal Outlet

It is designed as maintenance-free for a long time. With highly efficient and esthetic structure, it can be mounted at a desired angle. With the ability of both suction and blowing, these fans provide suction and air supply.

#### Technical Drawings

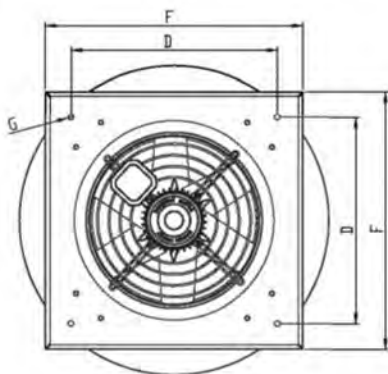
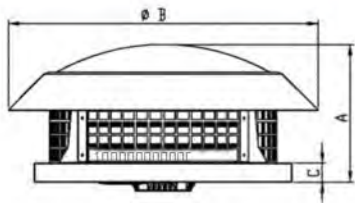

Between BACF 300 and BACF 500

#### MATERIAL

: The housing is made of electrostatic powder coated sheet iron; axial impeller is made of glass fiber mixed plastic.

#### INSULATION CLASS

: Class F

#### DIRECTIVE

: EN 60335-1, EN 60335-2-80

#### SPEED CONTROL

: Speed can be adjusted using an optional controller.

#### APPLICATION AREAS

: Residential; bathrooms, toilets, utility rooms, indoor swimming pools, gyms, and storerooms. Commercial; cafes, bars, restaurants, shops, schools, offices, factories, buildings, warehouses, night clubs, pubs, hotels, shopping centers, and leisure centers. Industrial; Equipment cooling, workshops, and spot ventilation.

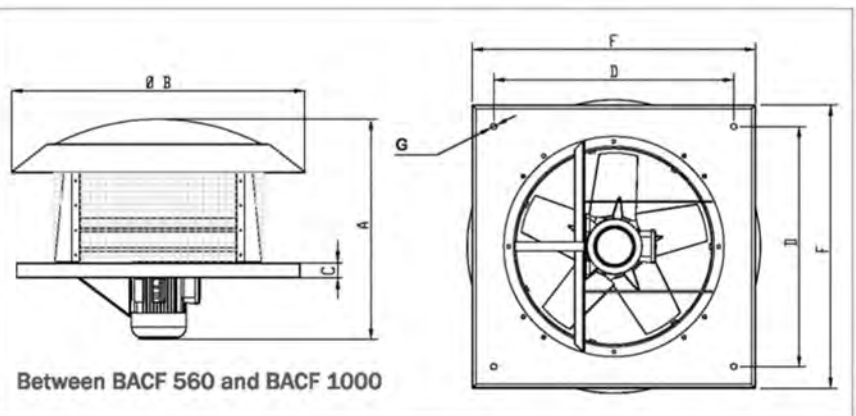

Between BACF 560 and BACF 1000

TYPE	A			D	F	G
BACF 300	340	685	40	450	560	12
BACF 350	340	685	40	450	560	12
BACF 400	470	824	40	530	630	12
BACF 450	480	824	40	590	710	12
BACF 500	480	824	40	680	740	12
BACF 560	710	1150	40	750	800	15
BACF 630	710	1150	40	750	850	15
BACF 710	800	1150	40	750	850	15
BACF 800	900	1450	40	900	1000	15
BACF 900	900	1450	40	900	1000	15
BACF 1000	950	1450	40	1000	1100	15

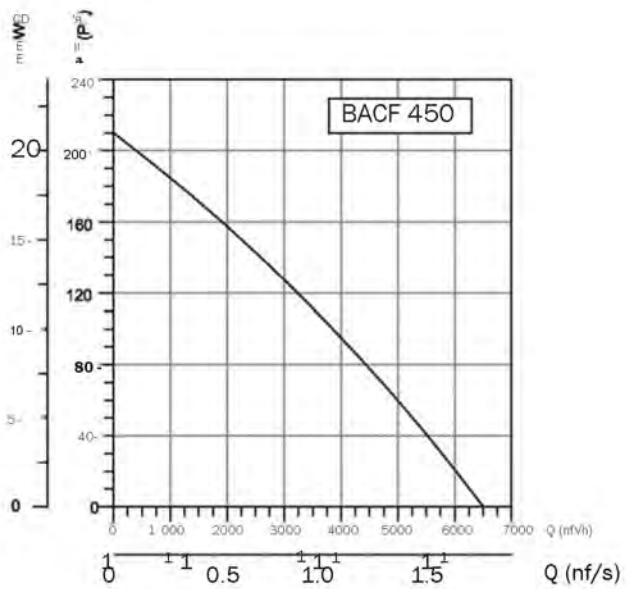
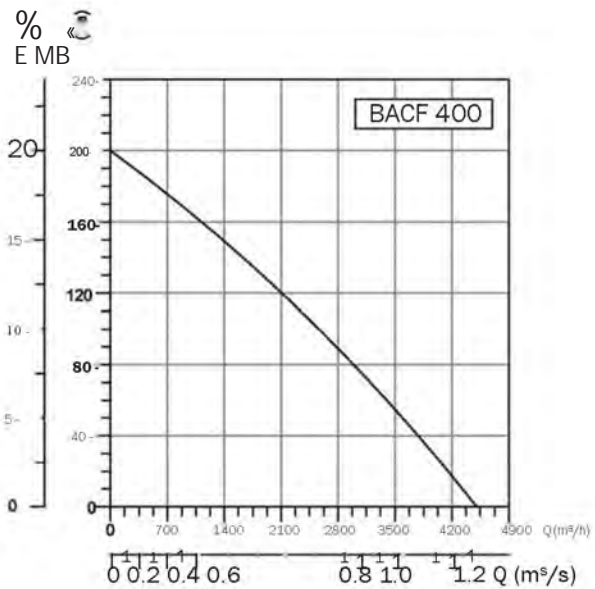
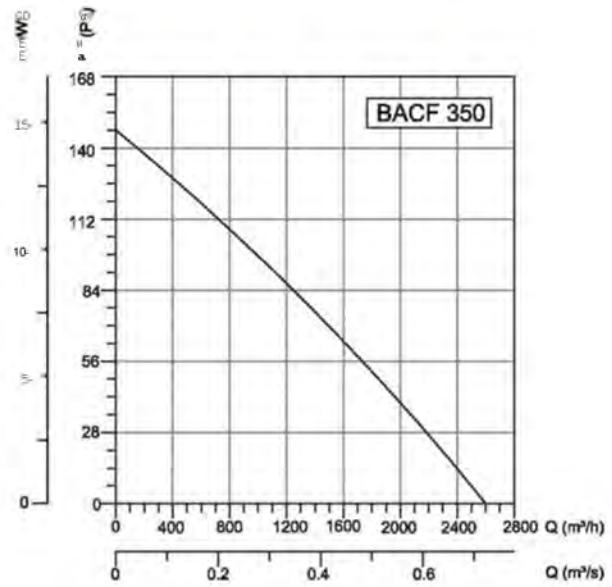
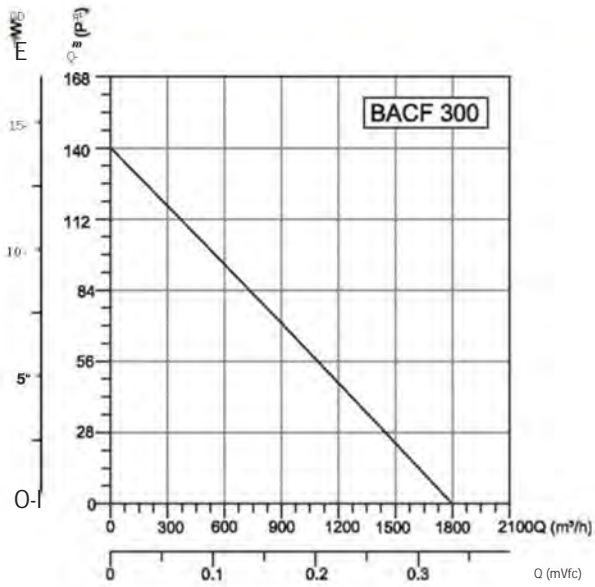

TYPE	VOLTAGE V	FREQUENCY Hz	a. w	a 1 6 (MF)	SPEED d/d	AIR FLOW m³/h	SOUND PRESSURE LEVEL dB(A)	WEIGHT kg
BACF 300M / BACF 300T	230/380	50	200	8/-	1430	1800	48	16
BACF 350M / BACF 350T	230/380	50	250	8/-	1360	2600	49	18
BACF 400M / BACF 400T	230/380	50	290	8/-	1400	4500	51	20
BACF 450M / BACF 450T	230/380	50	325	8/-	1375	6500	54	25
BACF 500M / BACF 500T	230/380	50	430	8/-	1350	8500	57	30
BACF 560M / BACF 560T	230/380	50	0,75	20/-	1450	10400	62	37
BACF 630M / BACF 630T	230/380	50	1	30/-	1450	14000	63	45
BACF 710M / BACF 710T	230/380	50	1,5	40/-	1450	18000	68	53
BACF 800M / BACF 800T	230/380	50	2,2	50/-	1450	26000	72	75
BACF 900T	380	50	3	-	1450	32000	77	80
BACF 1000T	380	50	5,5	-	1400	42000	91-100	105

# ROOF FANS

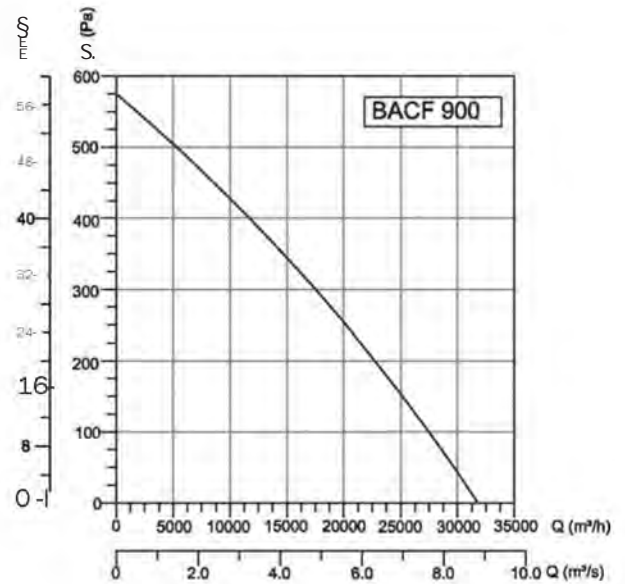
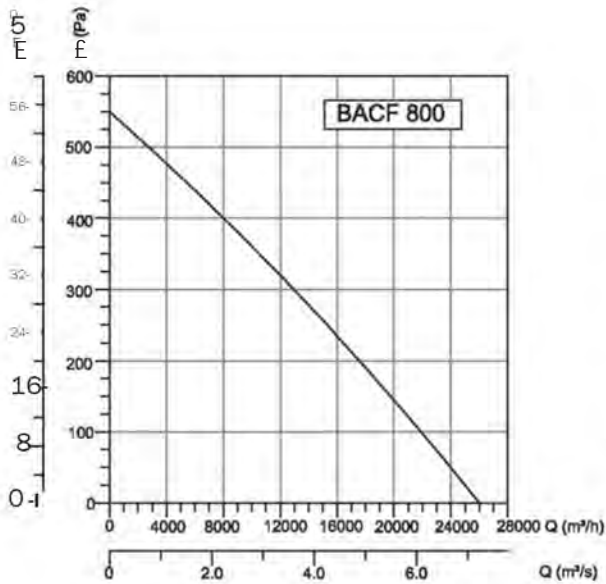
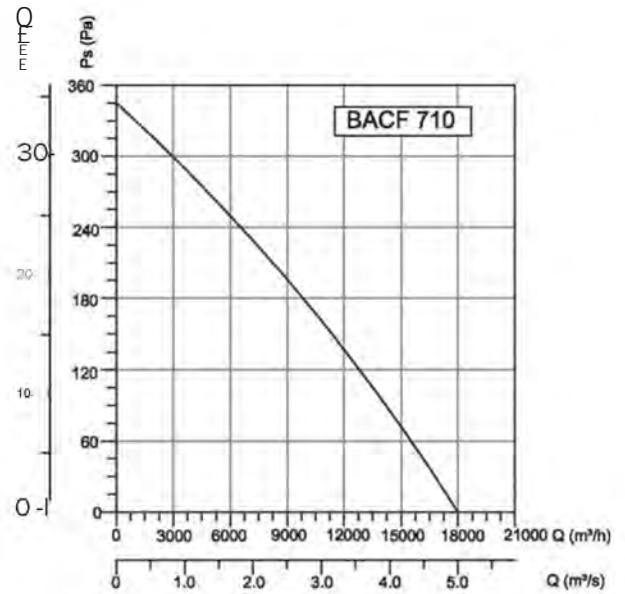
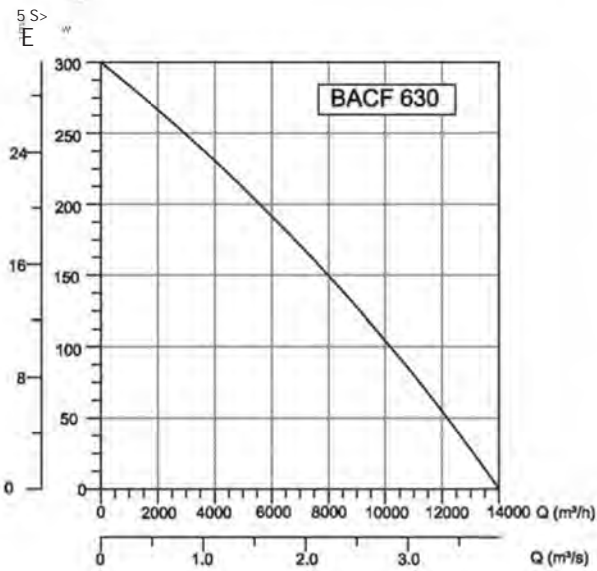
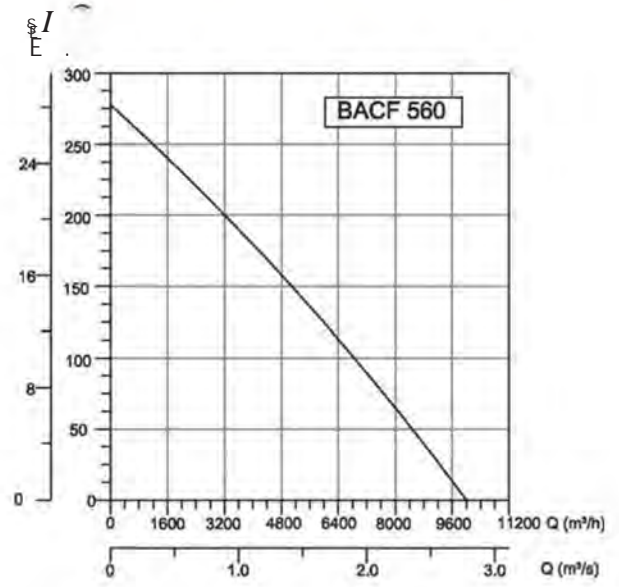
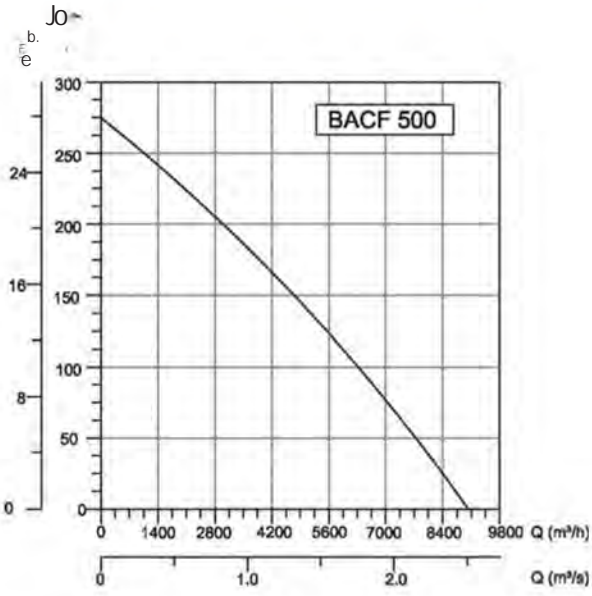



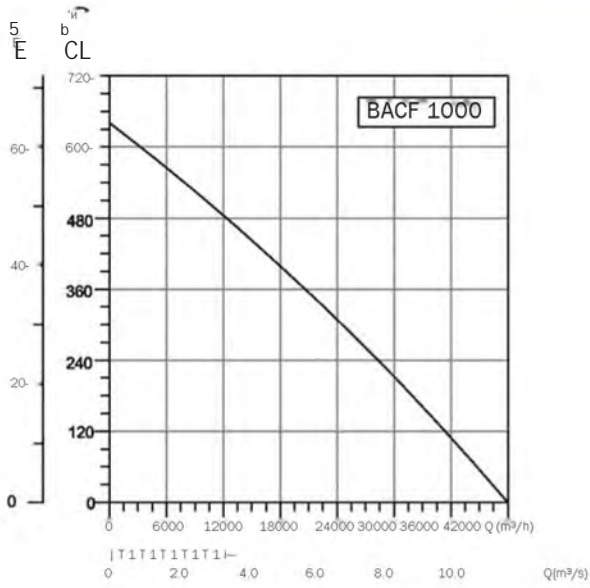



# AXIAL FANS

BK

BB

BDRAX

BORAX

4M-4T

B5P-B6P

B6PA

B5PA

BSM-BST

BSMS-BSTS

BTF-M



# BK

## AC AXIAL FANS Lid Option

Provides a strong air circulation in silence with the ideal vane angles.  
Can be mounted easily to windows and walls. With its lid, it is not affected from outer environmental factors when the fan is out of order.

### Technical Drawings

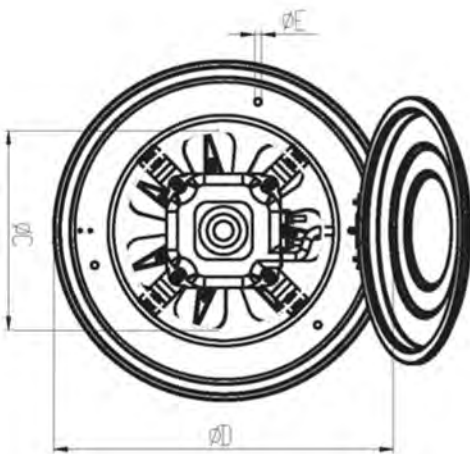
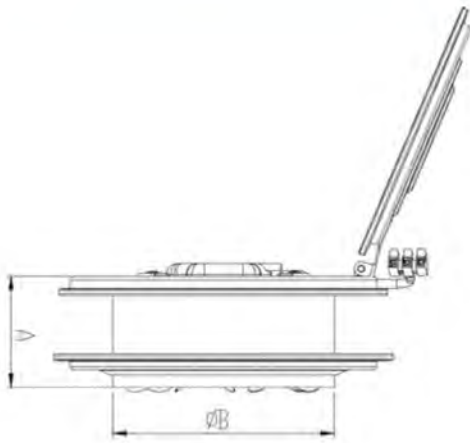

#### MATERIAL

- The housing is made of electrostatic powder coated sheet steel, impeller is made of aluminium.

#### INSULATION CLASS

- Class

#### DIRECTIVE

- EN 60335-1, EN 60335-2-80

#### SPEED CONTROL

- Speed can be adjusted using an optional controller.

#### APPLICATION AREAS

- Kitchens, bathrooms, offices, etc. for taking polluted air, smoke and undesired smells out.

### Accessories



### BSC

TYPE	A	B	C	D	E
BK160	80	162	148	236	5
BK 200	102	202	178	282	5
BK 250	102	248	234	332	5
BK300	102	298	284	380	5

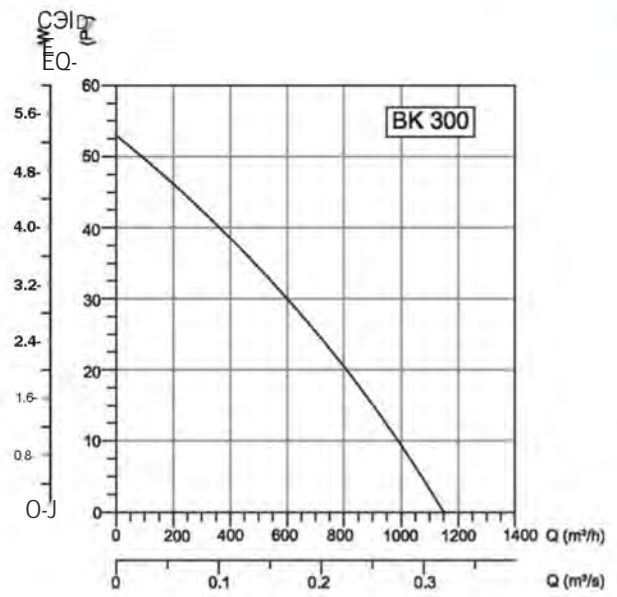
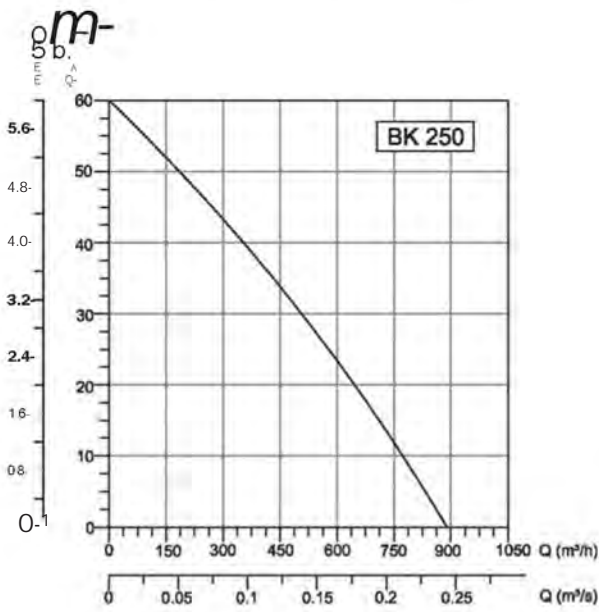
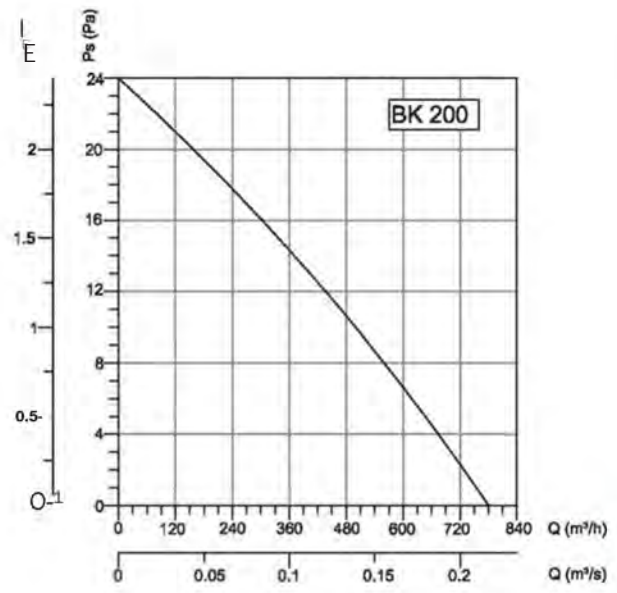
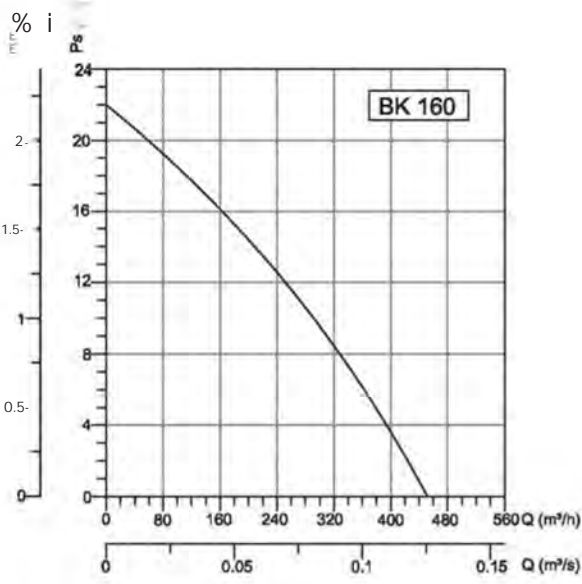

TYPE	VOLTAGE	FREQUENCY	POWER	CURRENT	SPEED	AIR FLOW	SOUND PRESSURE LEVEL	WEIGHT
	V	Hz	w	(A)	d/d	m³/h	dB(A)	kg
BK160	230	50	27	0,2	1340	450	50	1,8
BK 200	230	50	28	0,2	1250	780	53	2,1
BK 250	230	50	48	0,36	1390	890	57	3,1
BK300	230	50	70	0,53	1200	1150	65	3,6

# AXIAL FANS



## BB AC AXIAL FANS

Provides a strong air circulation in silence with the ideal vane angles. Can be mounted easily to windows and walls.

### Technical Drawings

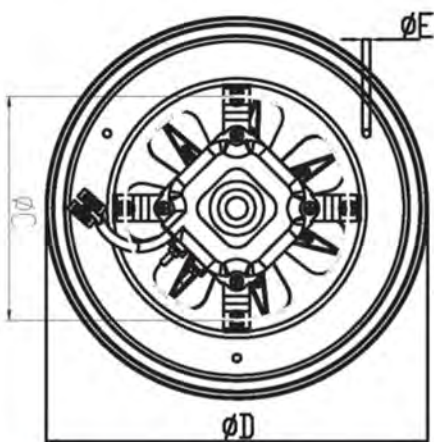
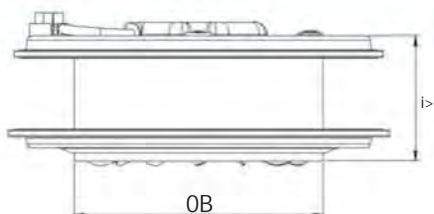

#### MATERIAL

- The housing is made of electrostatic powder coated sheet steel, impeller is made of aluminum,

#### INSULATION CLASS

- Class

#### DIRECTIVE

- EN 60335-1, EN 60335-2-80

#### SPEED CONTROL

- Speed can be adjusted using an optional controller,

#### APPLICATION AREAS

- Kitchens, bathrooms, offices, etc, for taking polluted air, smoke and undesired smells out,

### Accessories



BSC

TYPE	A			D	E
BB160	80	162	148	236	5
BB 200	102	202	178	282	5
BB 250	102	248	234	332	5
BB 300	102	298	284	380	5

Dimensions are in (mm)

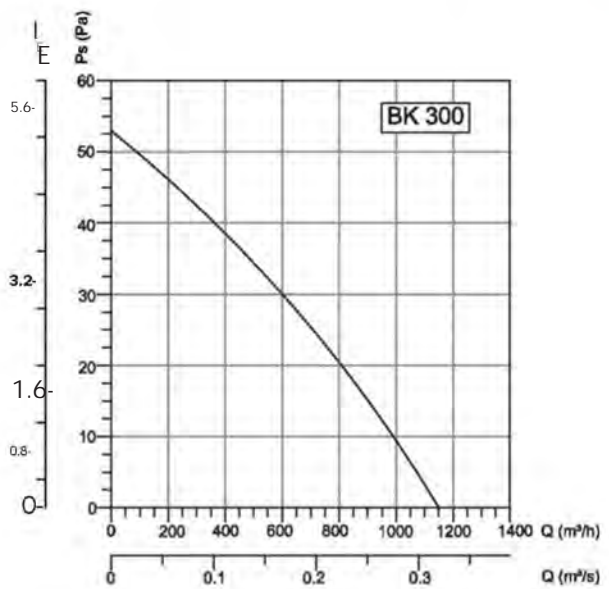
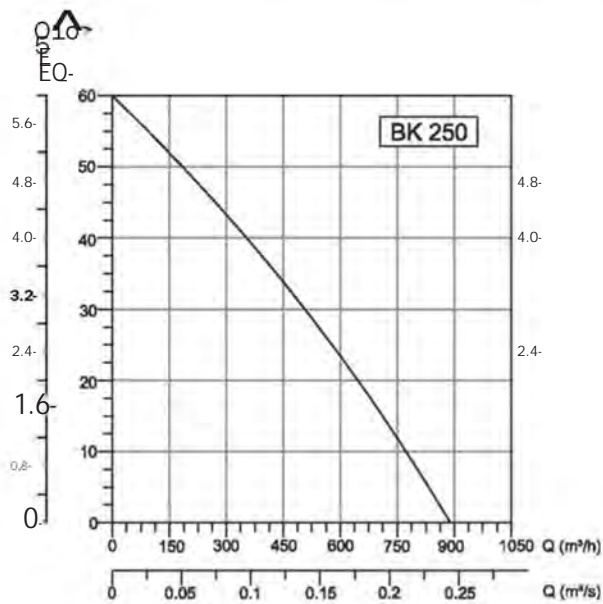
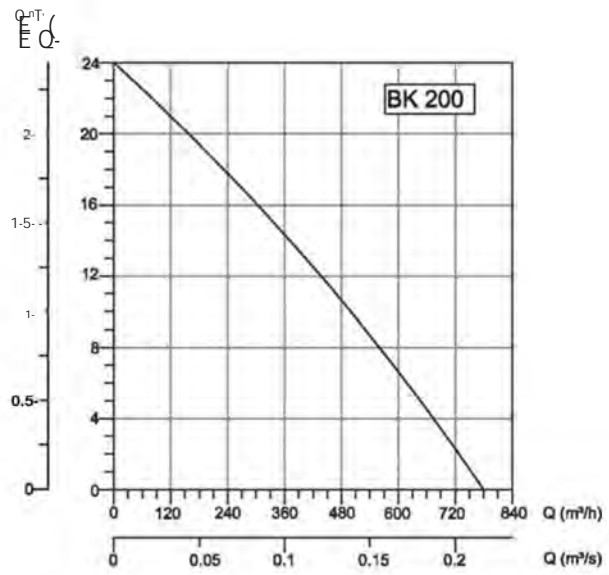
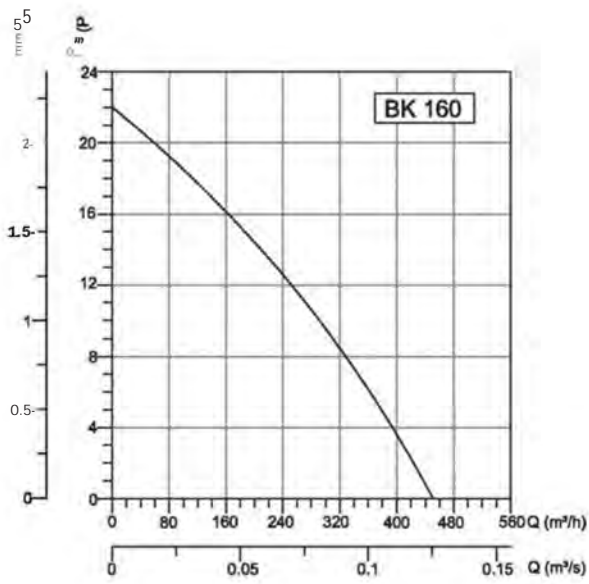

TYPE	VOLTAGE	FREQUENCY	POWER	CURRENT	SPEED	AIR FLOW	SOUND PRESSURE LEVEL	WEIGHT
	V	Hz						
BB160	230	50	25	0,16	1370	450	50	1,5
BB 200	230	50	30	0,2	1220	780	52	1,7
BB 250	230	50	55	0,4	1360	890	60	2,5
BB300	230	50	70	0,5	1225	1150	65	2,8



# BDRAX

## AC AXIAL FANS

They are ideal for applications where space is limited and high volume of airflow is needed.  
BDRAX fans work at minimum noise level.

### Technical Drawings

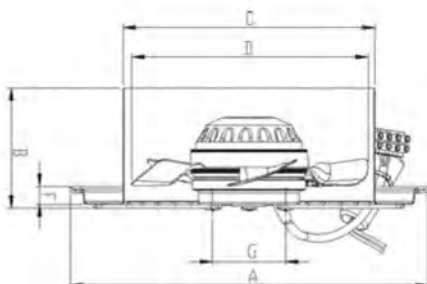
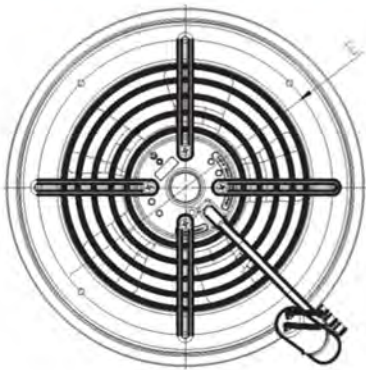

MATERIAL

: Casing is made of black powder coated sheet steel, impeller is made of electrostatic powder coated sheet and coupled with external rotor motor,

INSULATION CLASS

: Class

DIRECTIVE

: EN 60335-1, EN 60335-2-80

SPEED CONTROL

: Speed can be adjusted using an optional controller,

APPLICATION AREAS

: Electrical Panel Cooling, UPS Systems, Air Conditioning & Refrigeration, Welding Sets and Rectifiers Industrial & Domestic Exhaust Fans, other applications that need cooling with high air volume and low pressure,

### Accessories



**BSC**

TYPE	A			$\Delta$ D	E	F	G
BDRAX 200-2K	284	95	200	189	229	14	58
BDRAX 200-4K	284	95	200	189	229	14	58
BDRAX 250-2K	335	95	250	238	284	14	58
BDRAX 250-4K	335	95	250	238	284	14	58
BDRAX 300-2K	390	95	300	288	332	14	58
BDRAX 300-4K	390	95	300	288	332	14	58
BDRAX 350-2K	427	100	350	338	398	2	58
BDRAX 350-4K	427	100	350	338	398	2	58

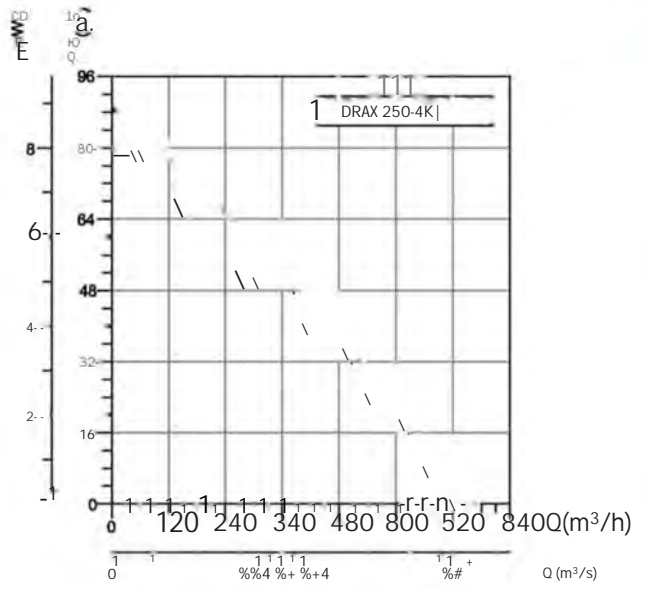
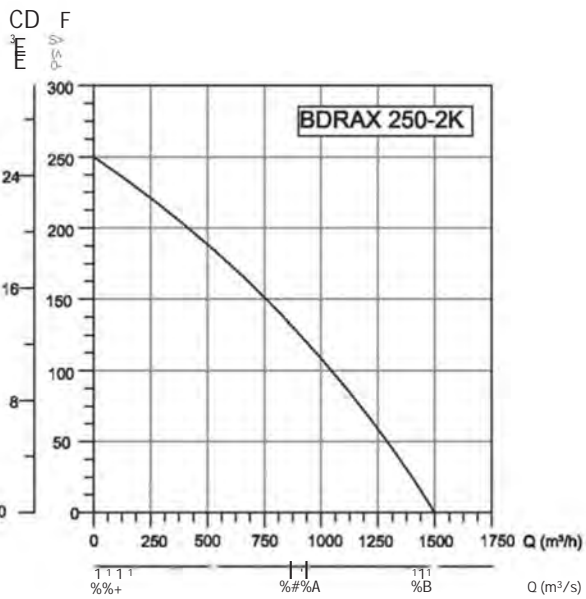
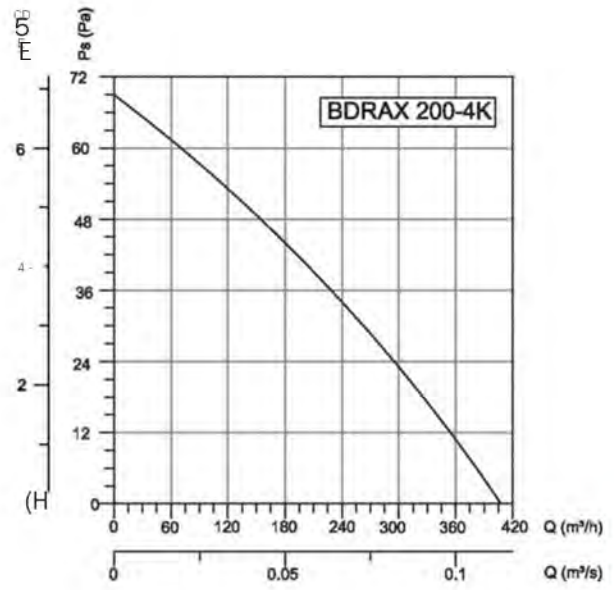
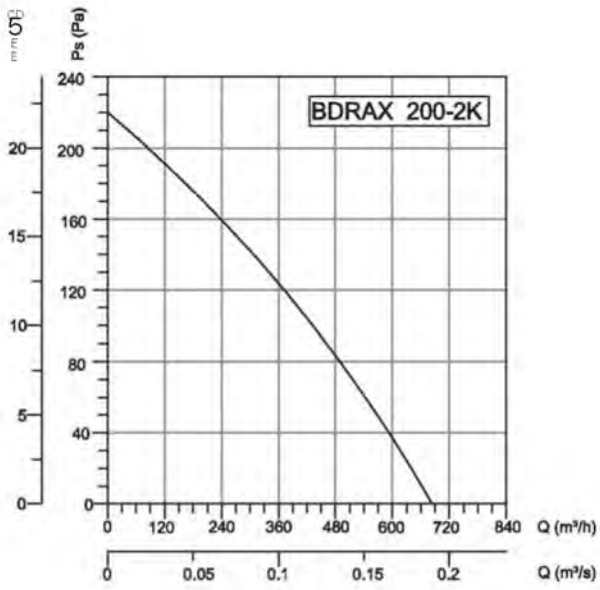

TYPE	V	FREQUENCY Hz	POWER KW	3 (A)	CAPACITOR (MF)	SPEED d/d	1 m³/h	SOUND PRESSURE LEVEL dB(A)	5 i*
BDRAX 200-2K	230	50	67	0,32	2,5	2700	680	60	2
BDRAX 200-4K	230	50	52	0,3	1,5	1420	407	50	2,2
BDRAX 250-2K	230	50	110	0,5	4	2640	1500	70	2,7
BDRAX 250-4K	230	50	56	0,3	1,5	1380	760	60	2,7
BDRAX 300-2K	230	50	160	0,63	5	2630	2020	72	3,5
BDRAX 300-4K	230	50	63	0,3	2	1360	1410	60	3,5
BDRAX 350-2K	230	50	240	1,08	5	2280	3110	78	4,6
BDRAX 350-4K	230	50	72	0,32	3	1330	2340	65	4,6



# AXIAL FANS

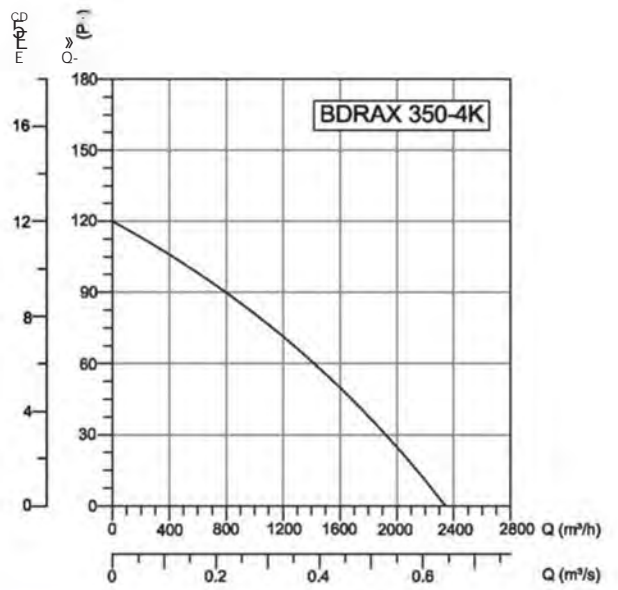
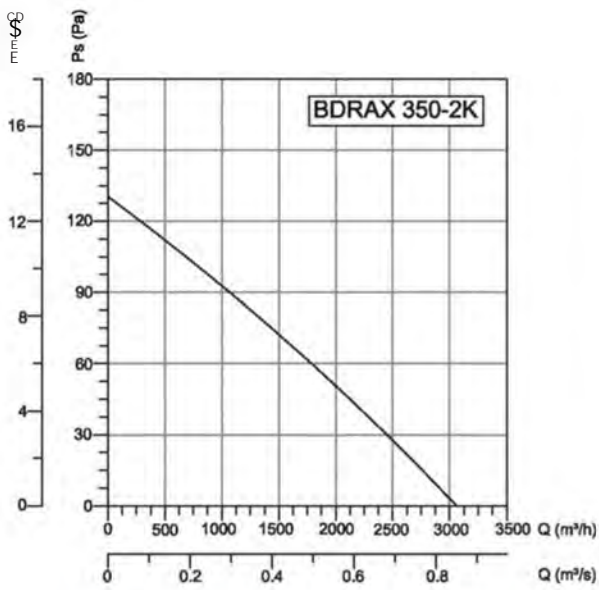
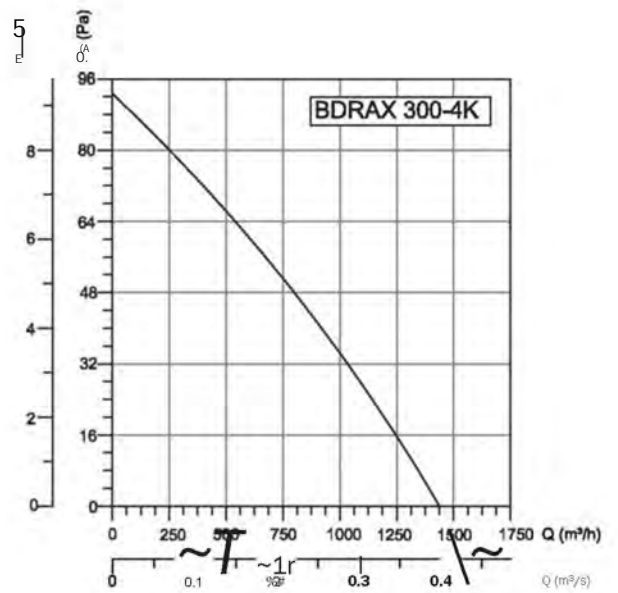
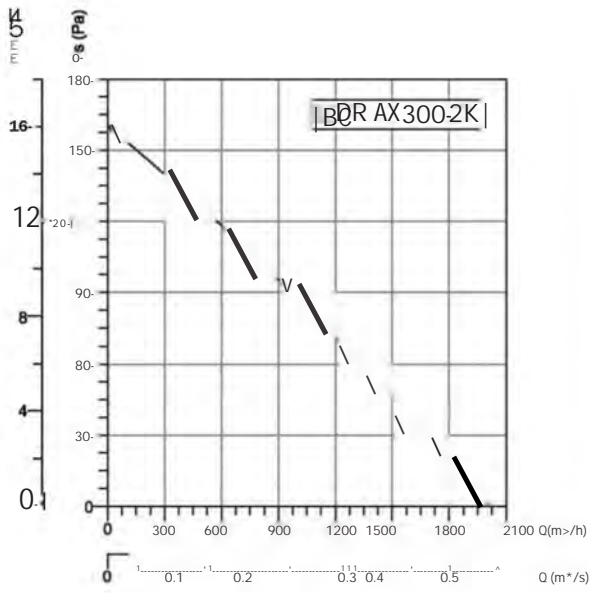

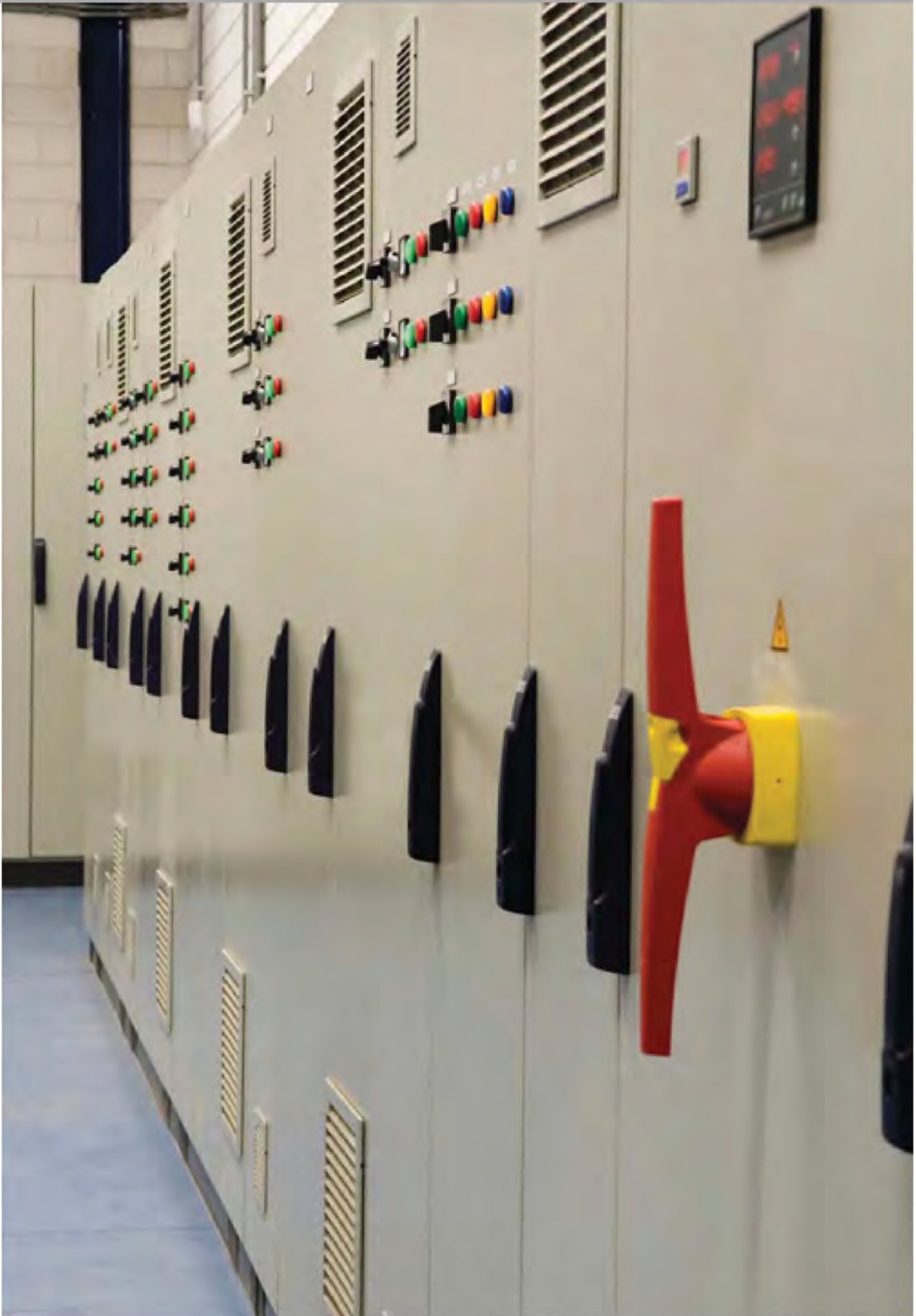

## AXIAL FANS



# BORAX

## AC AXIAL IN LINE DUCT FAN

BORAX fans are perfect for in-line ventilation applications. Protection grill prevent materials reach to blade, provides safe working.

### Technical Drawings

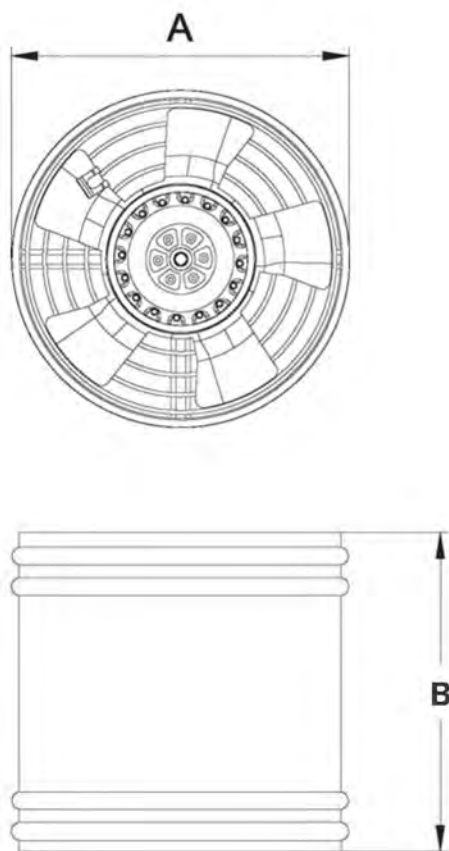

- MATERIAL** : Electrostatic Powder Coated impeller is made of sheet steel, Housing is galvanized sheet steel,
- INSULATION CLASS** : Class
- DIRECTIVE** : EN 60335-1, EN 60335-2-80
- SPEED CONTROL** : Speed can be adjusted using an optional controller,
- APPLICATION AREAS** : Electrical Panel Cooling, UPS systems, deep-freezers, cooling welding machines, residential ventilations etc,

### Accessories



BSC

TYPE	A	
BORAX 200-2K	200	200
BORAX 250-2K	250	250
BORAX 300-2K	300	250
BORAX 350-2K	355	250

Dimensions are in (mm)

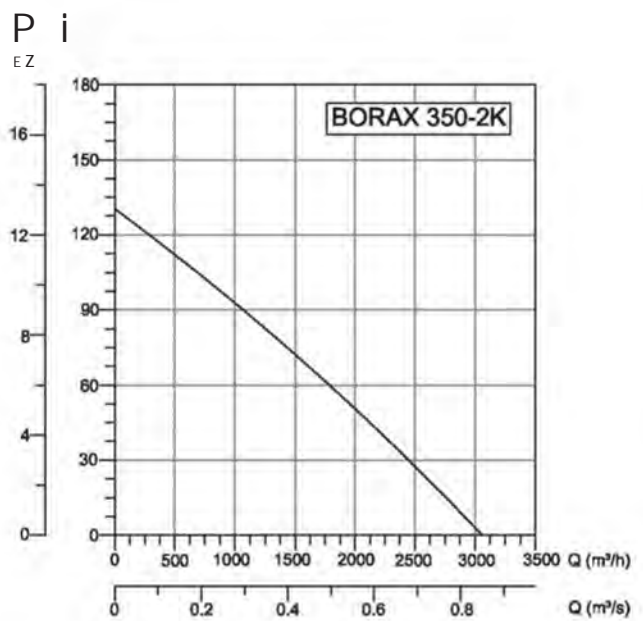
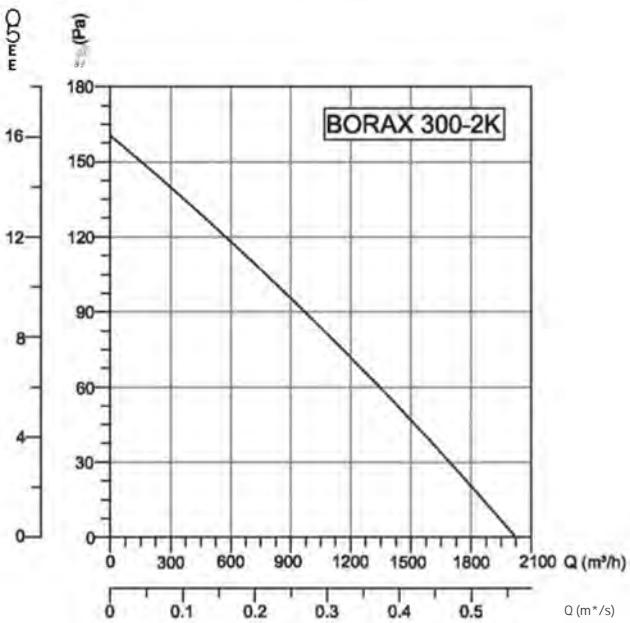
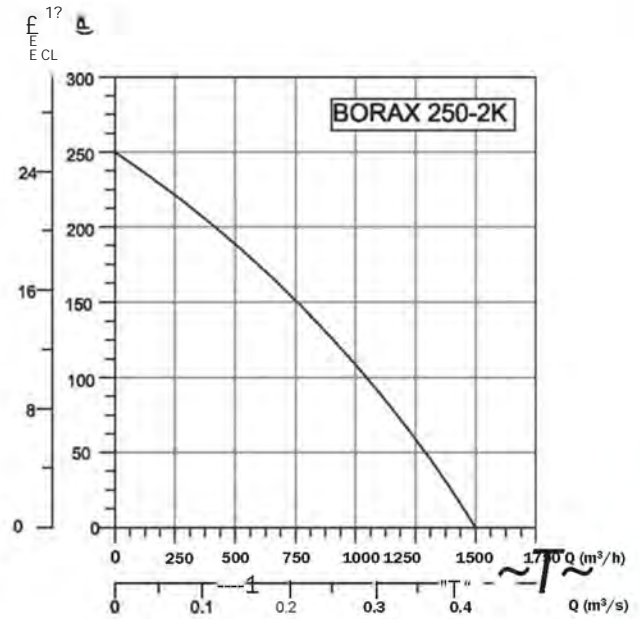
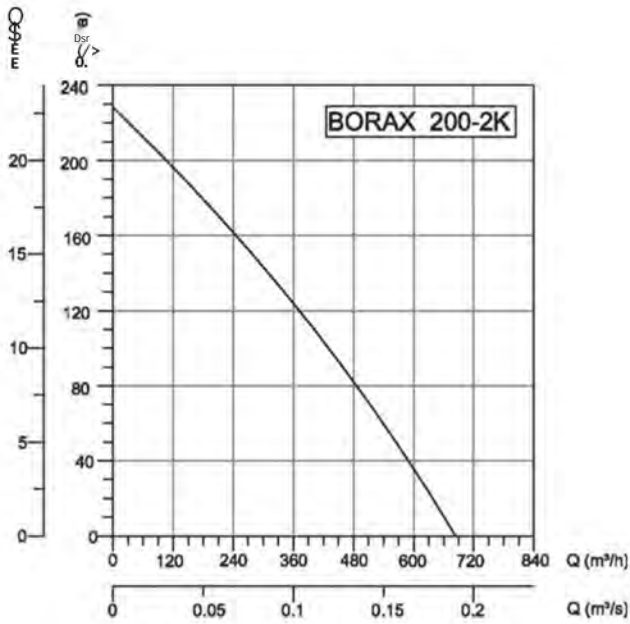

TYPE	VOLTAGE	FREQUENCY	POWER	CURRENT	CAPACITOR	SPEED	AIR FLOW	SOUND PRESSURE LEVEL	WEIGHT
	V	Hz	KW	(A)	(MF)	d/d	m³/h	dB(A)	kg
BORAX 200-2K	230	50	70	0,3	2,5	2650	680	50	2,7
BORAX 250-2K	230	50	100	0,46	4	2700	1500	52	3,6
BORAX 300-2K	230	50	163	0,63	5	2550	2025	54	4,6
BORAX 350-2K	230	50	240	1,1	5	2250	3110	58	5,6

# AXIAL FANS



## 4M-4T

AC COOLING FANS  
Single Phase & Three Phase

With suction and blowing types, 4M-4T cooling fans work trouble-free at high performance.

### Technical Drawings

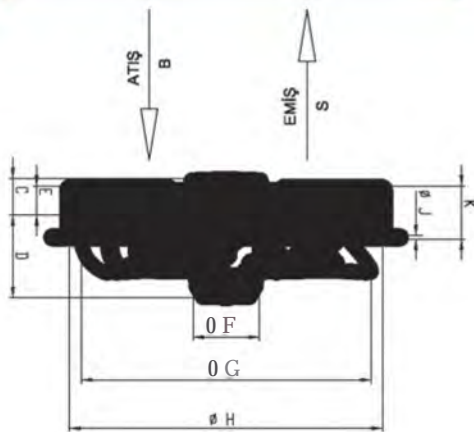

- MATERIAL** : Casing is made of electrostatic (black) powder coated sheet steel; impeller is made of sheet steel with an aerodynamic structure and connected to the motor,
- ROTATION** : CW (Clockwise)
- INSULATION CLASS** : Class & Class F
- DIRECTIVE** : EN 60335-1, EN 60335-2-80
- APPLICATION AREAS** : Cooling units, laboratories, cooling towers, cold stores etc,

TYPE	V	FREQUENCY	POWER	CURRENT	CE	SPEED	AIR FLOW	SOUND PRESSURE LEVEL	WEIGHT
	V	Hz	W	(A)	(MF)				
4M 250B/S	230	50	50	0,22	1,5	1380	1000	50	2,5
4M 300B/S	230	50	90	0,38	3	1370	1700	55	4
4M 350B/S	230	50	138	0,68	4	1370	2900	62	4,7
4M 400B/S	230	50	190	0,7	6	1350	3830	67	6,1
4M 450B/S	230	50	220	1,2	8	1380	4800	71	6,9
4M 500B/S	230	50	420	1,85	12	1320	6900	72	9,5
4T300B/S	380	50	95	0,26	-	1400	1750	55	4
4T350B/S	380	50	145	0,38	-	1390	2900	62	4,7
4T 400B/S	380	50	190	0,48	-	1380	3980	67	6,1
4T 450B/S	380	50	250	0,58	-	1400	4800	71	6,9
4T 500B/S	380	50	450	0,9	-	1320	6900	72	9,5

TYPE	A			D	E	F	G	H	J	
4M 250	7	310	55	75	30	92	250	275	3	80
4M 300	7	360	55	82	30	92	300	322	4	80
4M 350	9	422	55	108	30	102	350	375	5	80
4M 400	9	470	55	121	30	102	391	422	5	90
4M 450	9	522	55	133	30	102	446	475	5	90
4M 500	10	567	65	127	30	138	449	525	6	90
4T300	7	360	55	82	30	92	300	322	4	80
4T350	9	422	55	108	30	102	350	375	5	80
4T400	9	470	55	121	30	102	391	422	5	90
4T450	9	522	55	133	30	102	446	475	5	90
4T500	10	567	65	127	30	138	449	525	6	90

Dimensions are in (mm)

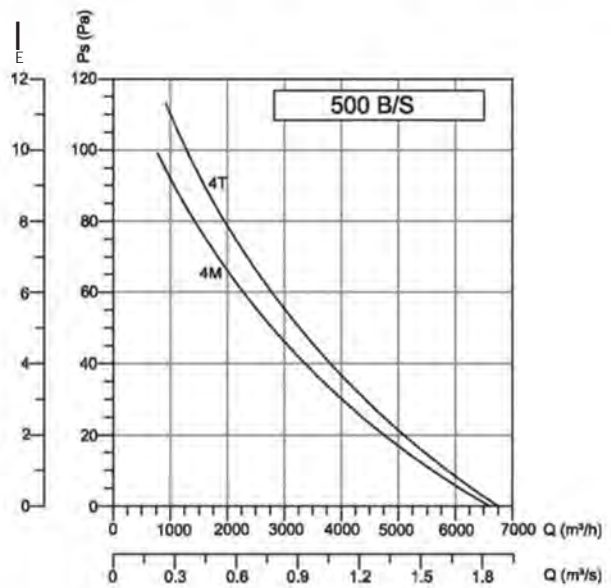
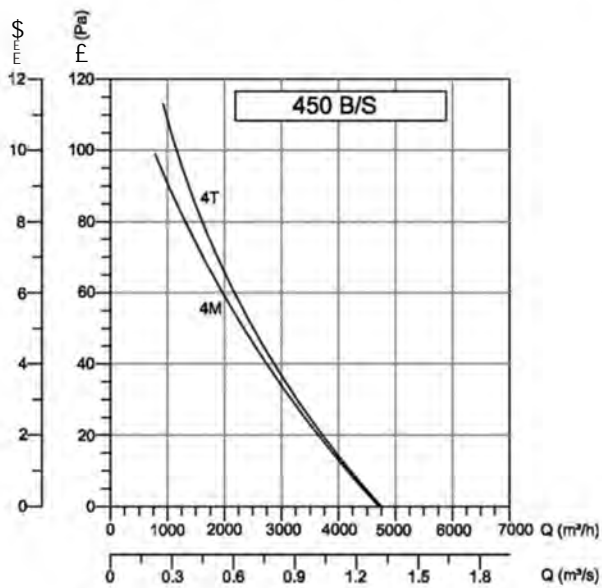
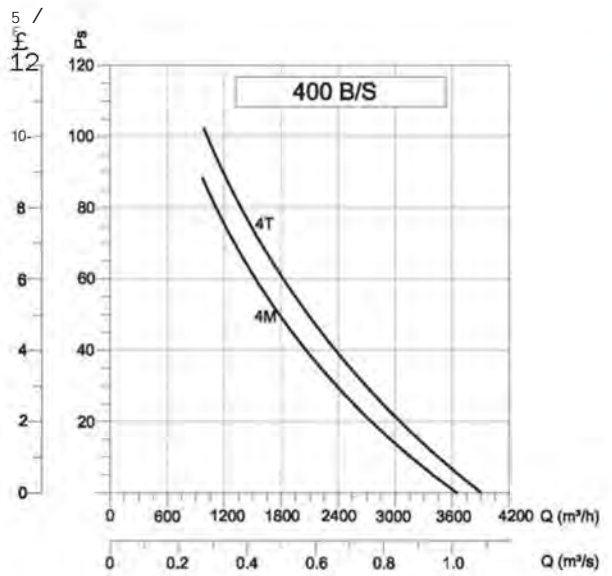
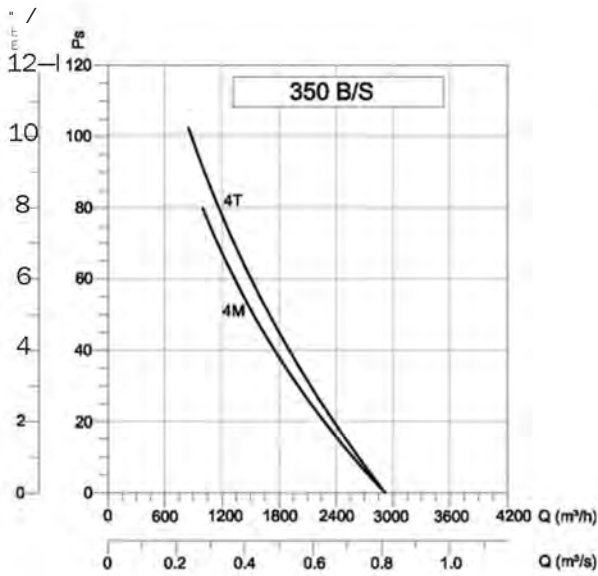
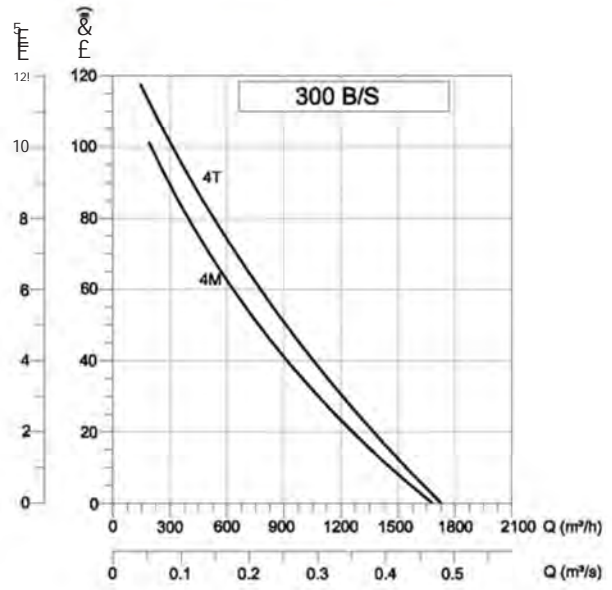
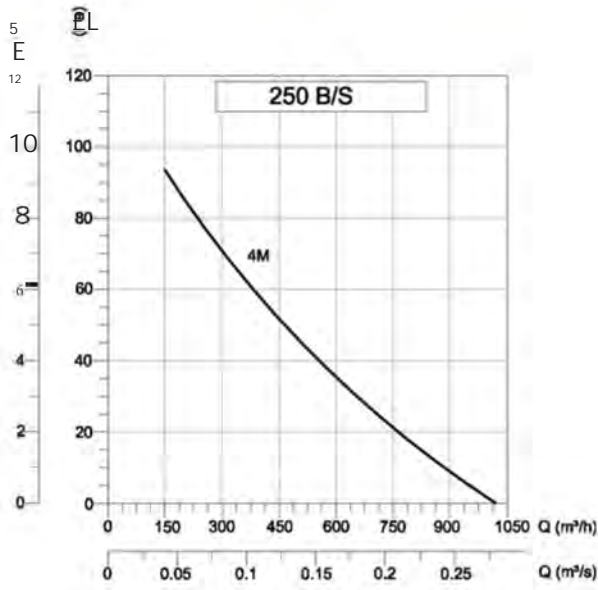

# AXIAL FANS



# 5 / 6

AC PLASTIC AXIAL BLADES

Adjustable Angles

The B5P, B6P Series of Axial Blades utilize wings with an airfoil profile. This profile is chosen for a wide range of applications including HVAC. Impeller has high diameter range to meet your specific application requirements. Temp. Range: -40°C + 100°C

## Technical Drawings

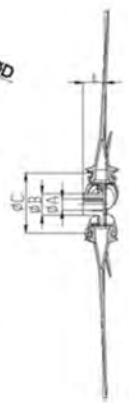
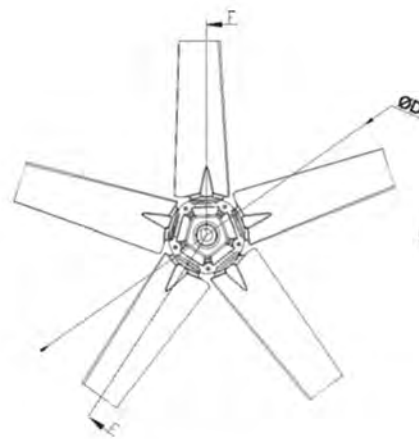
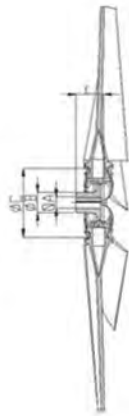
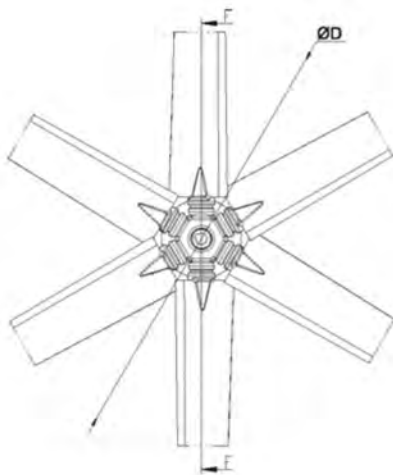

TYPE	ANGLE (a)	D	A		E
B6P 250	25 ° - 35 °	-42.5242	14	34	100 30
B6P300	25 ° - 35 °	-42.5292	14	34	100 30
B6P350	25 ° - 35 °	-42.5342	14	34	100 30
B6P400	25 ° - 35 °	-42.5392	14	34	100 30
B6P450	25 ° - 35 °	-42.5442	14	34	100 30
B6P500	25 ° - 35 °	-42.5	492	14 34	100 30
B6P600	25 ° - 30 ° - 35 °	-42.5	592	14 34	100 30

TYPE	ANGLE (a)	D	A		E
B5P600	25°-30°-35°-42.5°	592	14	44	155 43
B5P 700	25°-30°-35°-42.5°	692	19	44	155 43
B5P800	250-300-350-42.50	792	24	44	155 43
B5P900	250-300-350-42.50	892	28	56.5	155 43
B5P 1000	250-300-350-42.50	992	32	56.5	155 43
B5P1000B	25°-30°-35°-42.5°	992	38	56.5	155 43



DUCT FANS

ROOF FANS

**AXIAL FANS**

RADIAL FANS

PLASTIC FANS

VENTILATORS

SMOKE EXHAUST SYSTEMS

ACCESSORIES



# AXIAL FANS



## B6PA

### AC WALL MOUNTED AXIAL FANS Plastic Blade

Propellers are manufactured in ideal dimension and got maximum air flow. Designed to be installed directly into walls, ceiling or panels with it's square plate.

#### Technical Drawings

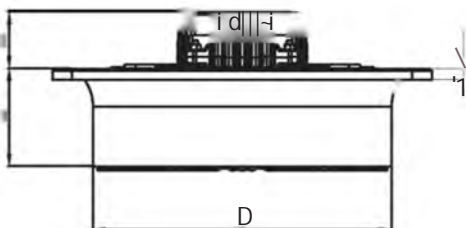
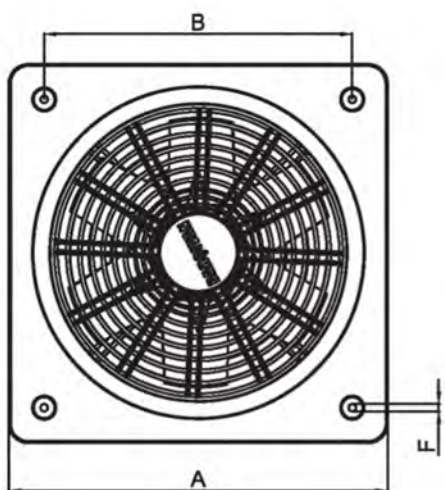

#### MATERIAL

: The casing is made of electrostatic powder coated sheet metal, impeller is made of plastic.

#### INSULATION CLASS

: Class and Class F

#### DIRECTIVE

: EN 60335-1, EN 60335-2-80

#### SPEED CONTROL

: Speed can be adjusted using an optional controller.

#### APPLICATION AREAS

: Factories, stock depots, dye-houses, shopping centers, big halls, etc.

#### Accessories



#### BSC

TYPE	1 g V	j B? Hz	(£ i W (A)	B? 4	a N d/d	i CE m³/h	LU dB(A)	kg
B6PAM 250/B6PAT 250230	50	190	1	8/-	1475	1500	60	7.3
B6PAM 300/B6PAT 300230	50	210	1,1	8/-	1445	2390	60	8.5
B6PAM 350/B6PAT 350230	50	270	1,3	8/-	1400	4080	63	9.9
B6PAM 400/B6PAT 400230	50	310	1,4	8/-	1350	5200	65	10.4
B6PAM 450/B6PAT 450230	50	360	1,6	8/-	1240	6100	63	11.4
B6PAM 500/B6PAT 500230	50	440	2	8/-	1130	7200	68	13.6

TYPE	A			D	E	F	G
B6PA 250	333	275	80	261	80	8.25	10
B6PA300	412	336	80	307	80	8.25	10
B6PA350	465	390	90	365	80	8.25	10
B6PA 400	500	420	100	403	80	8.25	10
B6PA 450	560	480	105	462	80	8.25	10
B6PA 500	630	561	110	513	90	8.25	10

Dimensions are in (mm)

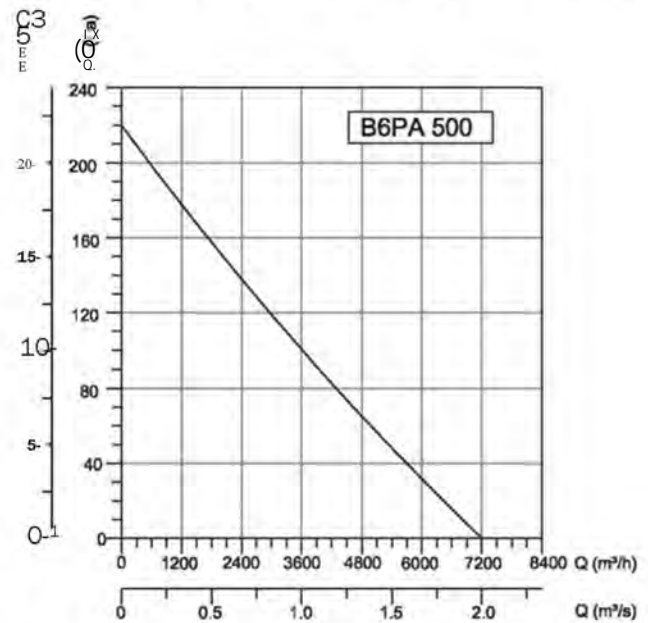
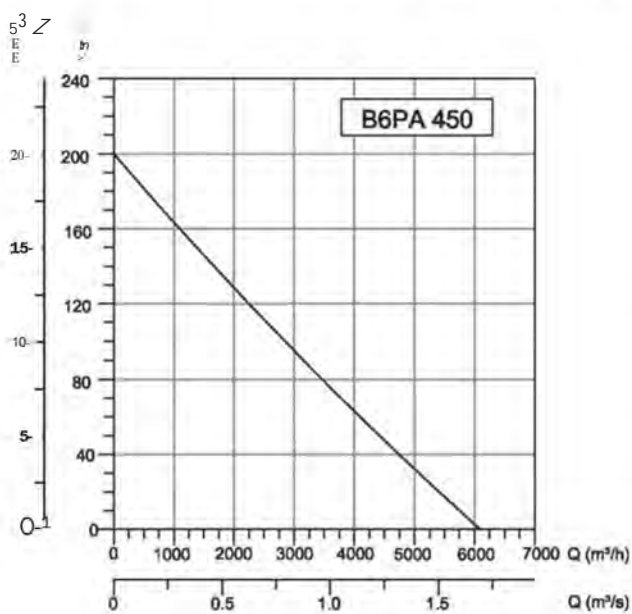
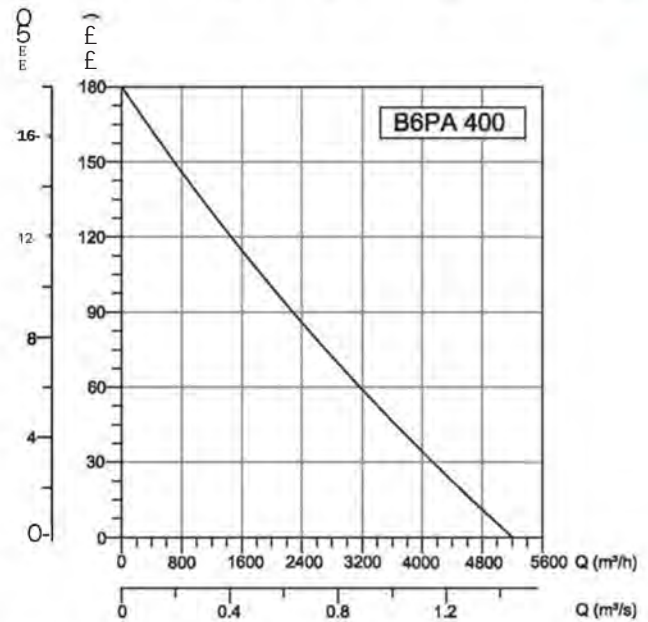
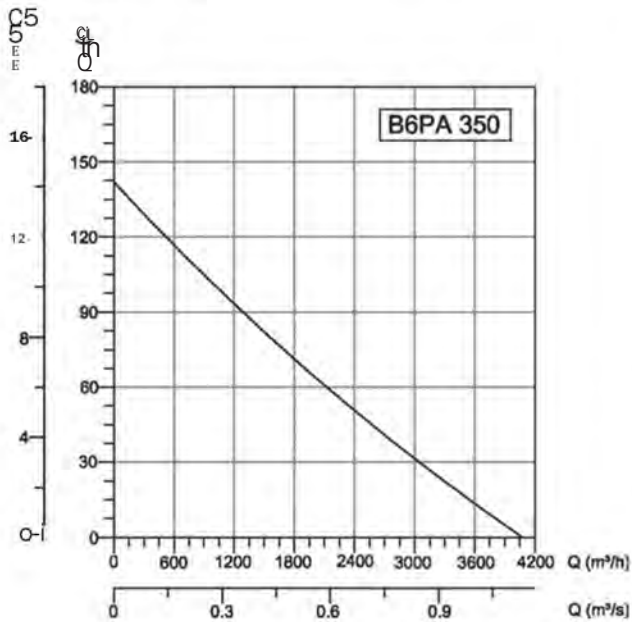
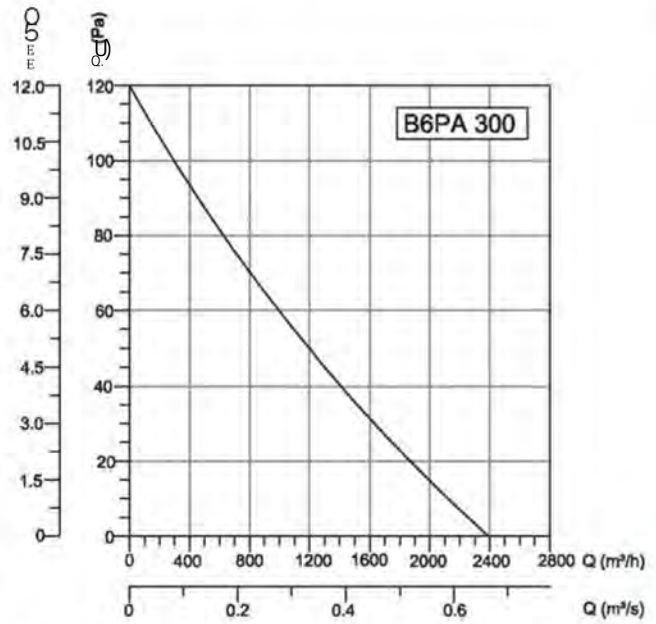
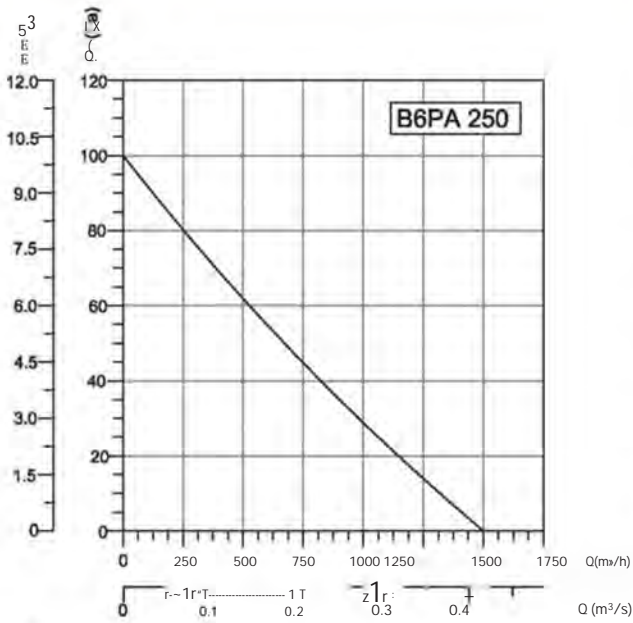



# B5PA

## AC WALL MOUNTED AXIAL FANS Plastic Blade

Propellers are manufactured in ideal dimension and got maximum air flow. Designed to be installed directly into walls, ceiling or panels with it's square plate.

### Technical Drawings

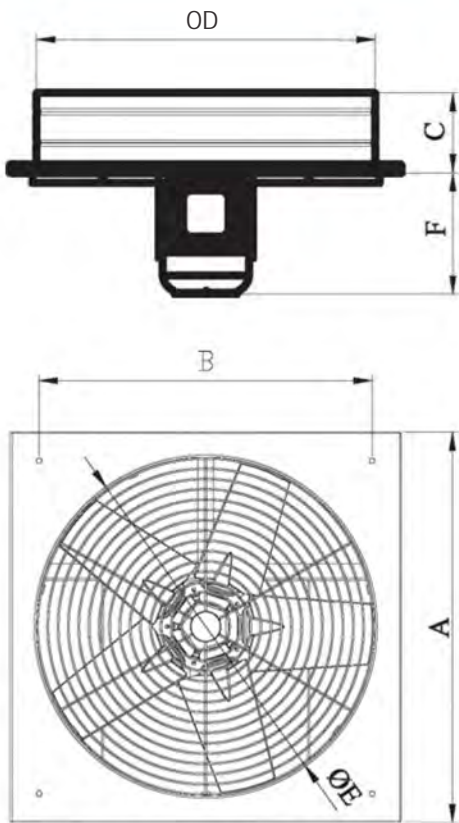

- MATERIAL** : The casing is made of electrostatic powder coated sheet metal, impeller is made of plastic.
- INSULATION CLASS** : Class and Class F
- DIRECTIVE** : EN 60335-1, EN 60335-2-80
- 3SPEED CONTROL** : 3speed can be adjusted using an optional controller.
- APPLICATION AREA** : Factories, stock depots, dye-houses, shopping centers, big halls, etc.

### Accessories



TYPE	A			D	e	F
B5PA 500	600	460	125	510	492	239
B5PA 600	700	550	125	610	592	239
B5PA 700	800	640	170	730	690	259
B5PA 800	950	770	220	830	780	284
B5PA 900	1100	900	250	930	880	336
B5PA 1000	1200	960	250	1030	990	375

Dimensions are in (mm)

TYPE	VOLTAGE	FREQUENCY	POWER	CURRENT	3SPEED	AIR FLOW	300UND PRESSURE LEVEL	WEIGHT
	V	HZ	lw	(A)	d/d	m/h	dB(A)	kg
B5PAM 500/ B5PAT 500	230/380	50	0.55	3,3/1,5	1400	8500	69	16.6
B5PAM 600/ B5PAT 600	230/380	50	0.75	4,6/2	1400	10500	75	20.5
B5PAM 700/ B5PAT 700	230/380	50	1.1	7,1/2,6	1400	14000	82	33
B5PAM 800/ B5PAT 800	230/380	50	2.2	13,4/5,1	1400	20000	85	52
B5PAT900	230/380	50	4	8,2	1400	32000	88	61
B5PAT 1000	230/380	50	5.5	11,3	1400	37000	91	90



mmHg a.

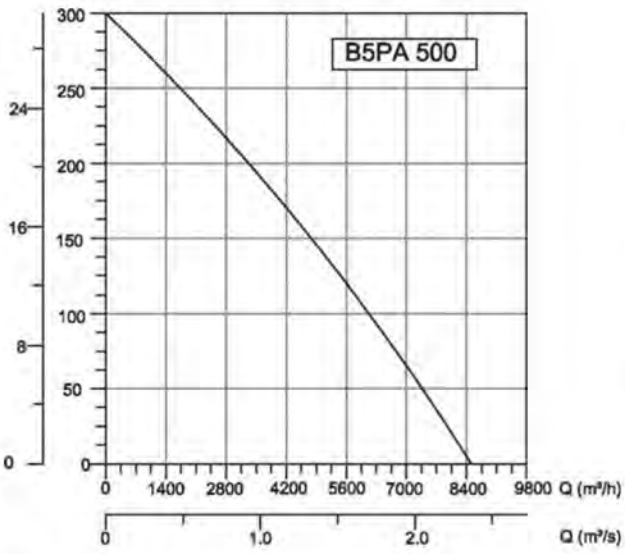

mmHg CD1=

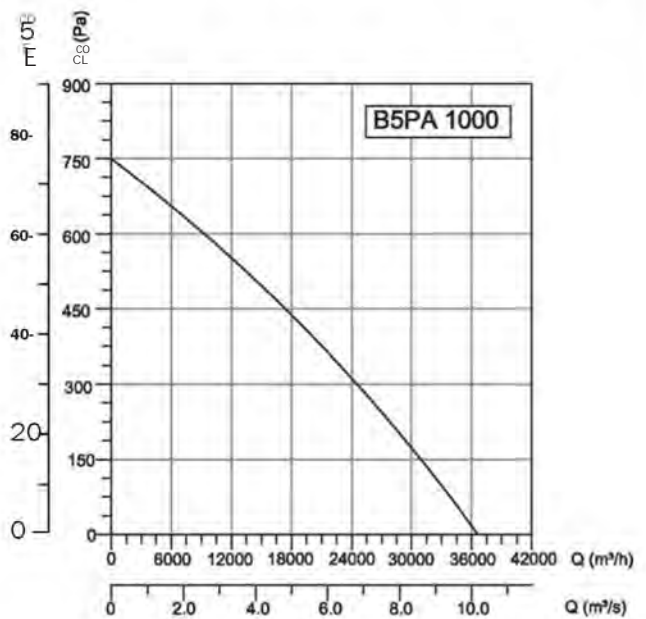
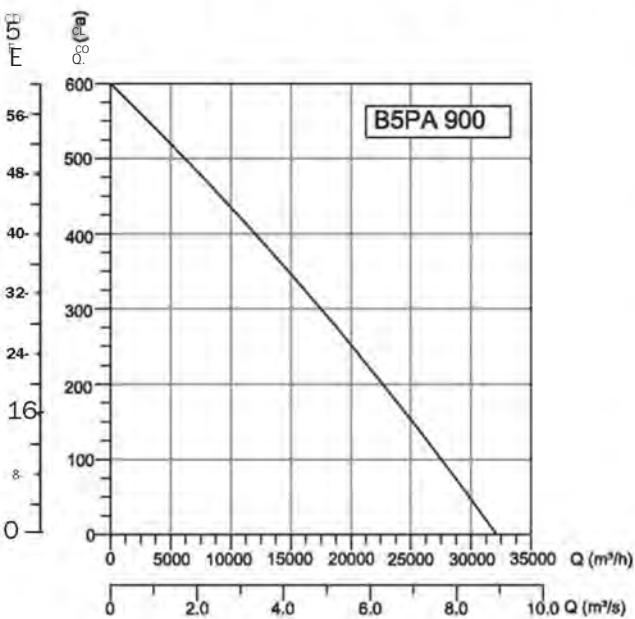
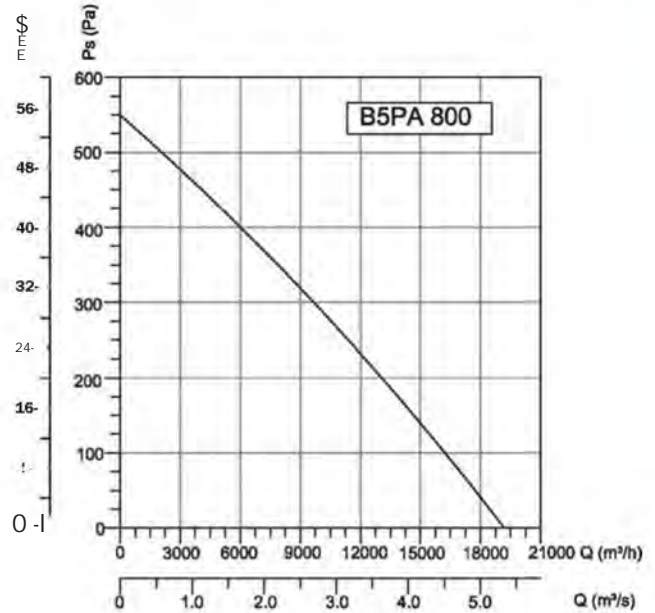
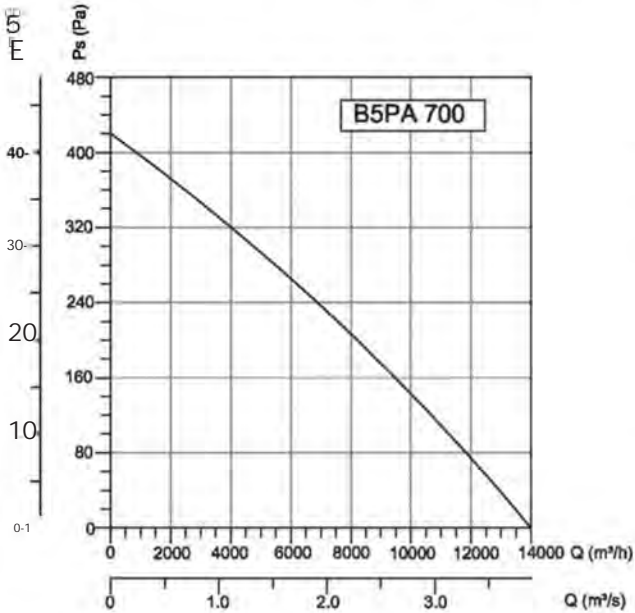
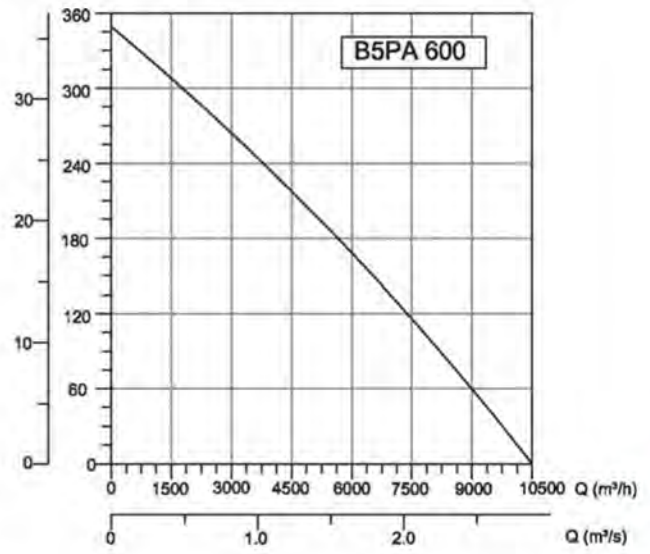

# AXIAL FANS



# BSM - BST

## AC INDUSTRIAL AXIAL FANS

Directly coupled motor, (single phase-three phase) 6 blades with concave blade system, Suitable for mounting on wall and window,

### Technical Drawings

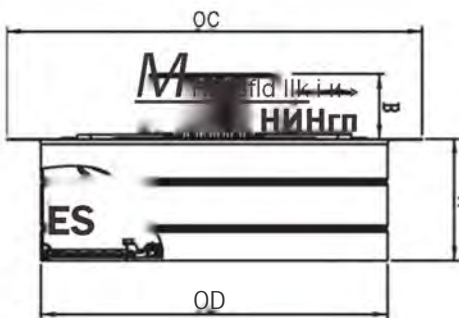
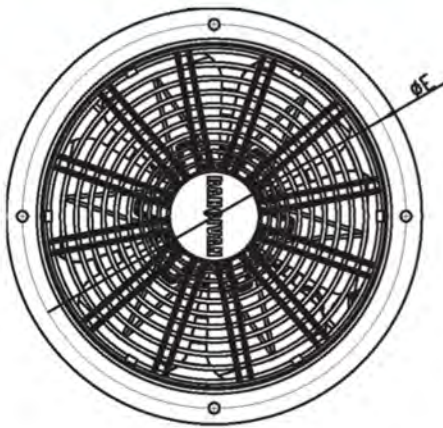

#### MATERIAL

- Housing is made of electrostatic powder coated sheet metal, impeller is made of sheet metal with concave blade system

#### INSULATION CLASS

- Class

#### DIRECTIVE

- EN 60335-1, EN 60335-2-80

#### SPEED CONTROL

- Speed can be adjusted using an optional controller.

#### APPLICATION AREAS

- Factories, depots, dyehouses, shopping centers, workshops(plants) etc.

TYPE	VOLTAGE	FREQUENCY	POWER	CURRENT	КАПАЦИТОРА	SPEED	AIR FLOW	SOUND PRESSURE LEVEL	WEIGHT
	V	Hz	W	(A)	(MF)	d/d	m <sup>3</sup> /h	dB(A)	kg
BSM 250-2K/BST 250-2K	230/380	50	1985	0,8	2900	2200	70	7.4	
BSM 250/BST 250	230/380	50	170	1,08	8	1465	1200	52	7.4
BSM 300/BST 300	230/380	50	210	1,2	8	1400	2000	60	8
BSM 350/BST 350	230/380	50	200	1,18	8	1400	3250	58	8.2
BSM 400/BST 400	230/380	50	230	1,2	8	1420	4500	65	8.8
BSM 450 /BST 450	230/380	50	240	1,2	8	1385	5000	65	10
BSM 500/BST 500	230/380	50	245	1,2	8	1335	5500	70	11
BSM 550 /BST 550	230/380	50	240	1	10	1350	6000	60	14.6
BSM 600/BST 600	230/380	50	235	1	10	1370	8000	65	15.6

TYPE	A	B	C	D	E
BSM 250-2K / BST 250-2K	114	61	304	251	277
BSM 250/BST 250	114	61	304	251	277
BSM 300/BST 300	114	61	390	325	360
BSM 350 /BST 350	114	61	435	374	405
BSM 400 /BST 400	114	61	485	427	455
BSM 450 /BST 450	114	61	546	470	516
BSM 500 /BST 500	125	61	590	518	560
BSM 550 /BST 550	130	160	624	560	595
BSM 600 /BST 600	130	160	674	610	645

Dimensions are in (mm)

# BSMS - BSTS

AC WALL MOUNTED AXIAL FANS

Directly coupled motor, (single phase-three phase) 6 blades with concave blade system, Suitable for mounting on wall and window, Easy installation due to its square plate,



**MATERIAL**

- Housing is made of electrostatic powder coated sheet metal as square shaped, impeller is made of sheet metal with concave blade system,

**INSULATION CLASS**

- Class

**DIRECTIVE**

- EN 60335-1, EN 60335-2-80

**SPEED CONTROL**

- Speed can be adjusted using an optional controller,

**APPLICATION AREAS**

- Factories, depots, dyehouses, shopping centers, workshops(plants) etc,

## Technical Drawings

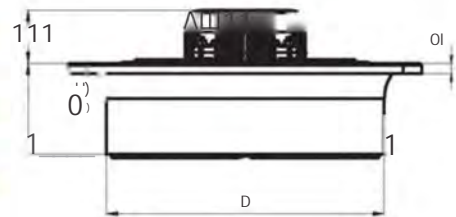
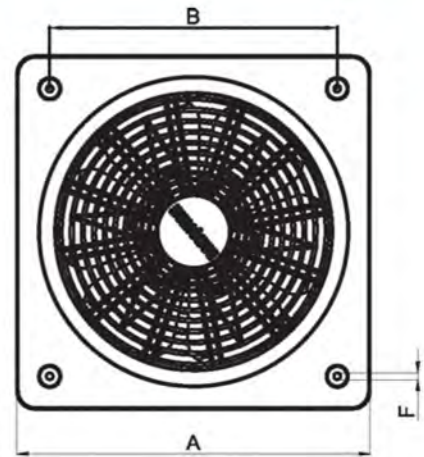

TYPE	v Hz	W	(A)(MF)	d/d	m <sup>3</sup> /h	dB(A)	kg
------	------	---	---------	-----	-------------------	-------	----

BSMS2502K/BS1S2502K 230/380 50 195 0,87	8	2900	2200	70	6,3		
BSMS 250/BSTS 250 230/380 50 170 1,08	8	1465	1200	52	6		
BSMS 300/BSTS 300 230/380 50 210 1,2	8	1400	2000	60	7		
BSMS 350/BSTS 350 230/380 50 200	1,1	8	1400	3250	58	8,2	
BSMS 400/BSTS 400 230/380 50 230			1,2	8	1420	4500	8
BSMS 450/BSTS 450 230/380 50 240			1,2	8	1385	5000	70
BSMS 500/BSTS 500 230/380 50 245			1,2	8	1335	5500	75
BSMS 550/BSTS 550 230/380 50 240			1	10	1350	6000	70
BSMS 600/BSTS 600 230/380 50 235	10				1370	8000	75

TYPE	A	D	E	F	G
BSMS 250-2K/ BSTS 250-2K	333	275	80	261	80
BSMS 250/ BSTS 250	333	275	80	261	80
BSMS 300/BSTS 300	412	336	80	307	80
BSMS 350/BSTS 350	465	390	90	365	80
BSMS 400/BSTS 400	500	420	100	403	80
BSMS 450/BSTS 450	560	480	105	462	80
BSMS 500/ BSTS 500	630	561	110	513	90
BSMS 550/ BSTS 550	660	585	145	565	135
BSMS 600/ BSTS 600	700	631	145	612	135

Dimensions are in (mm)

# AXIAL FANS

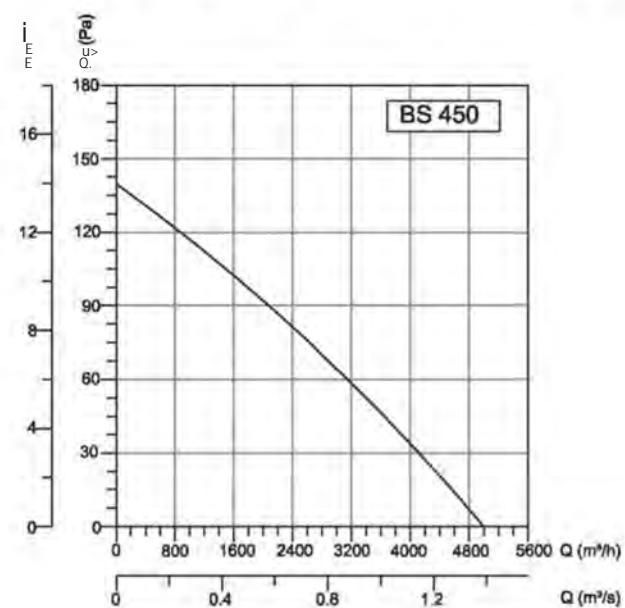
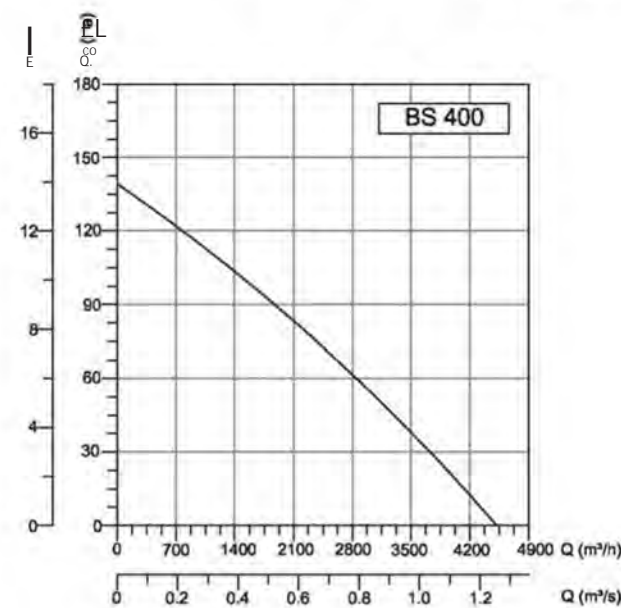
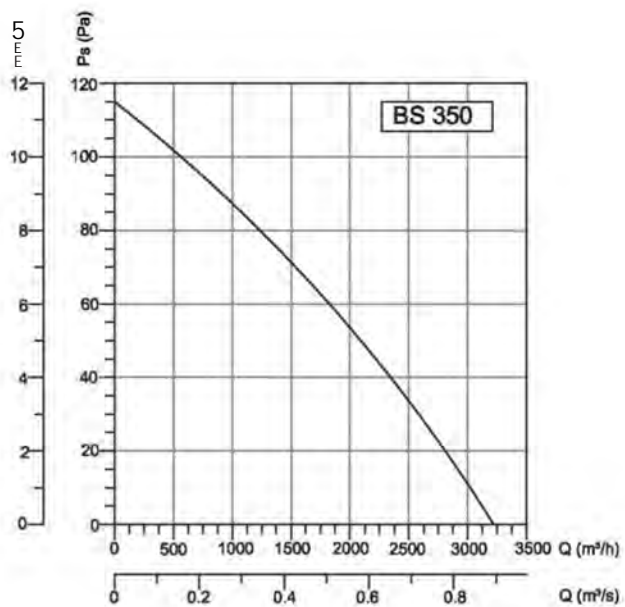
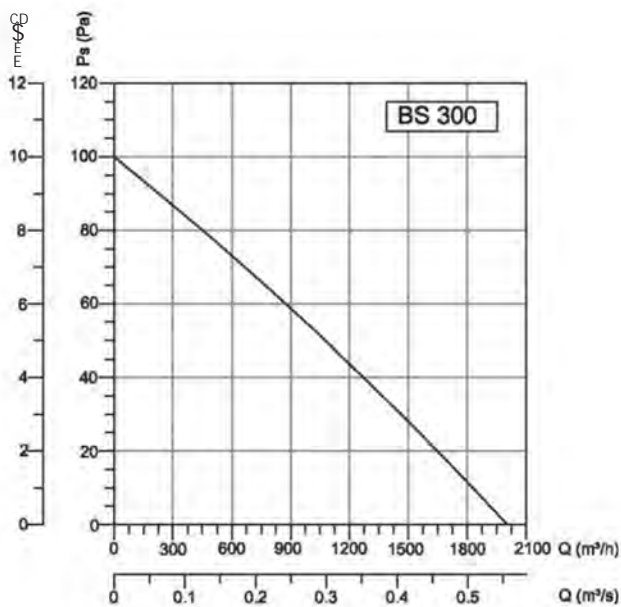
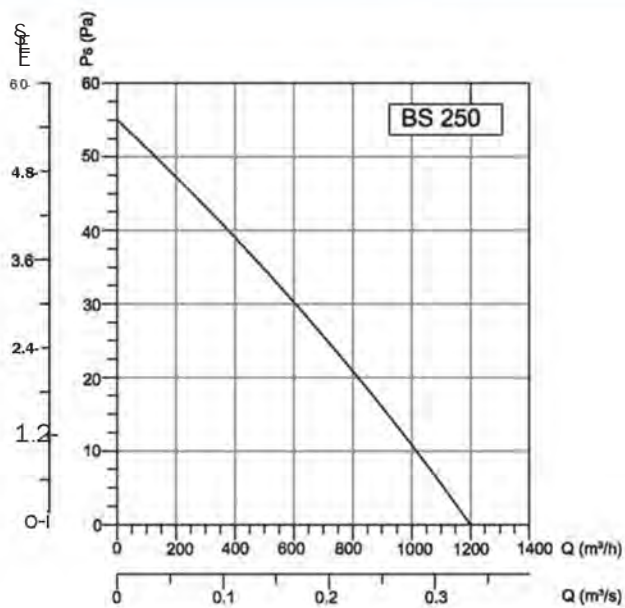
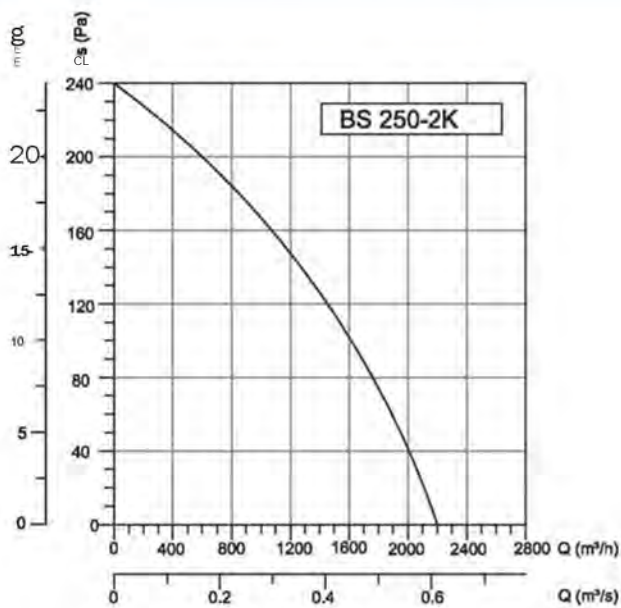

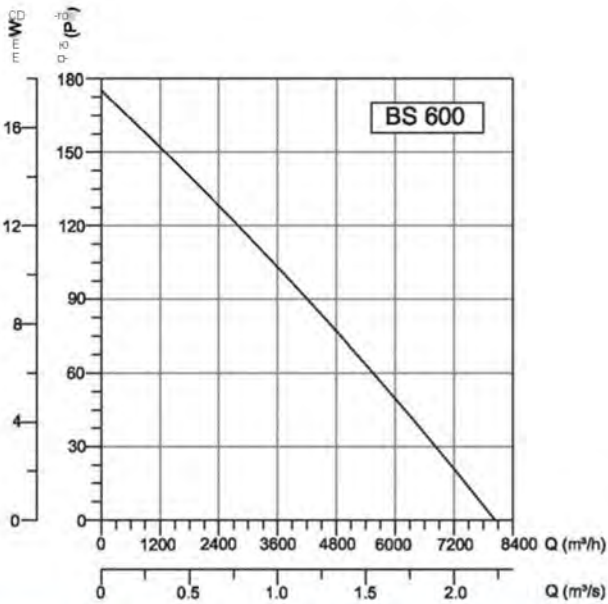
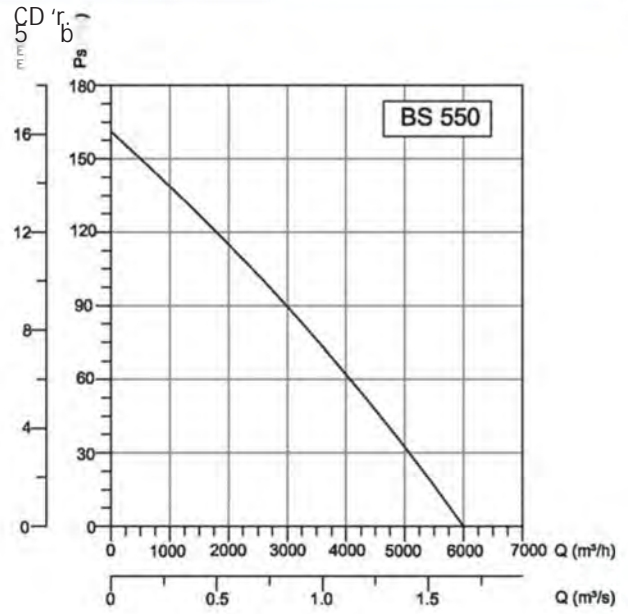
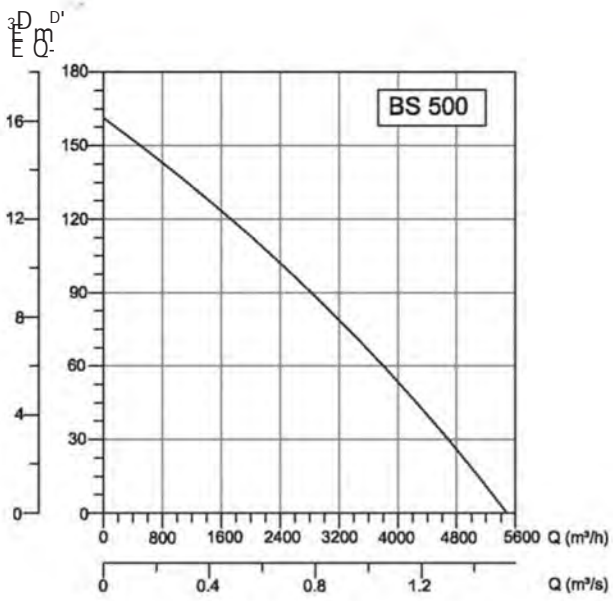



# AXIAL FANS



## BTF-M

### AC TUBE FANS

Tube Fans are manufactured between diameters 400 mm - 1000 mm and with different blade angles combinations. Direct coupled motor (Single Phase-Three Phase)

#### Technical Drawings

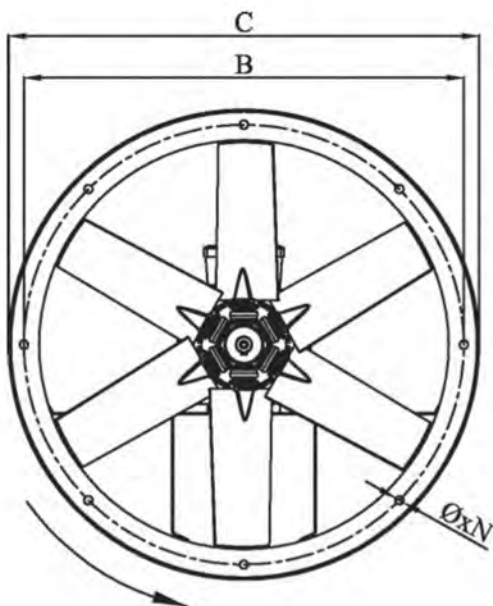
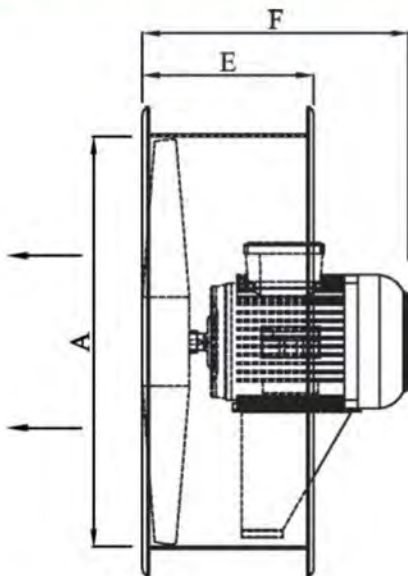

#### MATERIAL

: Housing is made of electrostatic powder coated St 37.2 sheet steel, Can be manufactured with legs upon request. Impeller is made of special mixed aluminum injected (RA-MAX) material. Also can be manufactured reversible and adjustable angles option.

#### INSULATION CLASS

: Class F

#### DIRECTIVE

: EN 60335-1, EN 60335-2-80

#### SPEED CONTROL

: Speed can be adjusted using an optional controller.

#### APPLICATION AREAS

: In the middle or at the end of duct applications, technical, industrial, commercial applications, wet and dusty areas, foundries, paper or wood factories, cooling towers etc.

TYPE	MOTOR			E	F	NxØ
BTFM 400	71	435	470	200	312	8x10
BTFM 450	80	485	520	200	340	8x10
BTFM 500	80	535	570	270	350	8x10
BTFM 560	90S	595	630	270	390	8x10
BTFM 630	90L	665	700	270	415	8x10
BTFM 710	100L	745	780	300	460	8x10
BTFM 800	100L	835	870	300	460	8x10
BTFM 900	132S	935	970	350	555	8x10
BTFM 1000	132 M	1035	1070	415	555	8x10

Dimensions are in (mm)



TYPE	POWER	SPEED	FREQUENCY	SOUND PRESSURE LEVEL	AIR FLOW	WEIGHT
	Kw	d/d	Hz	dB(A)	m <sup>3</sup> /h	cg
BTFM 400	0,37	1350	50	65	4000	20
BTFM 450	0,55	1350	50	70	6000	23
BTFM 500	0,75	1400	50	72	8000	30
BTFM 560	1,1	1400	50	73	11000	36
BTFM 630	1,5	1400	50	74	15000	40
BTFM 710	2,2	1400	50	74	20500	50
BTFM 800	3	1400	50	92	27300	63
BTFM 900	5,5	1400	50	76	35000	90
BTFM 1000	7,5	1450	50	79	51000	115

# AXIAL FANS

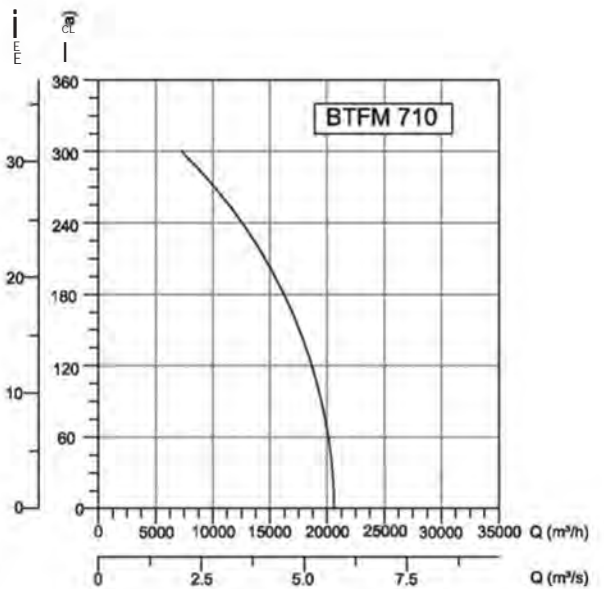
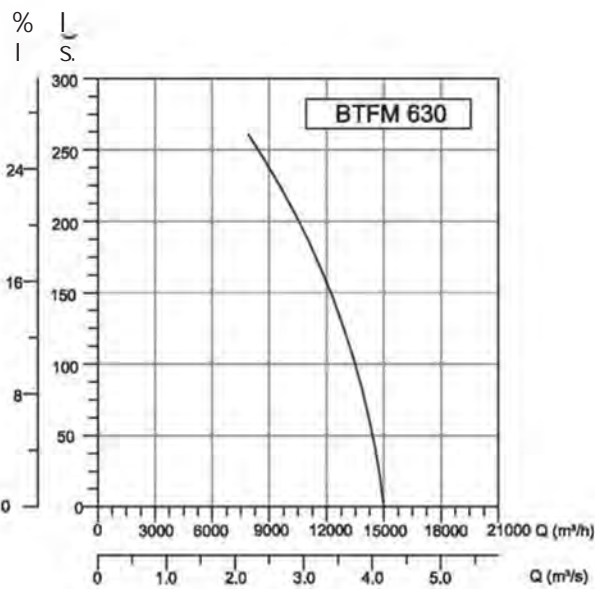
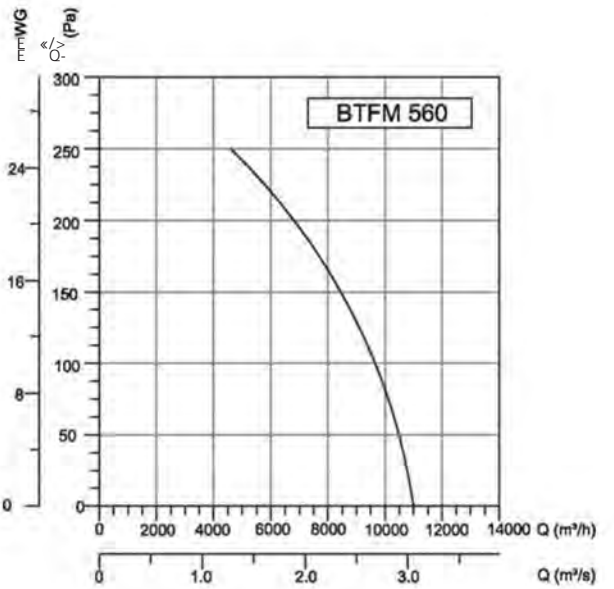
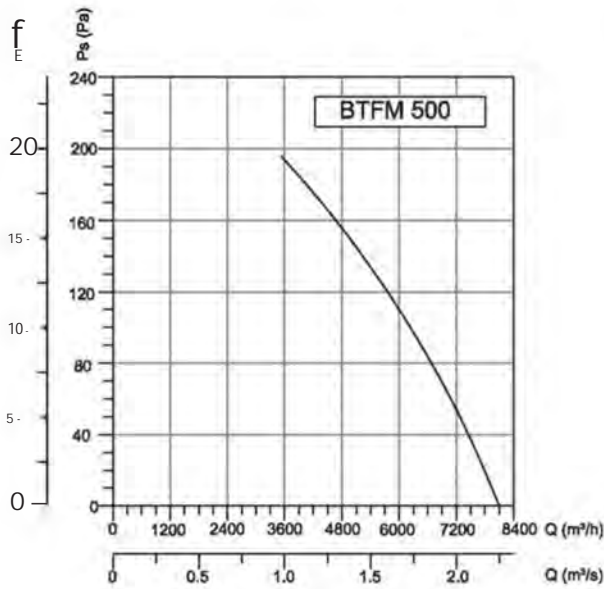
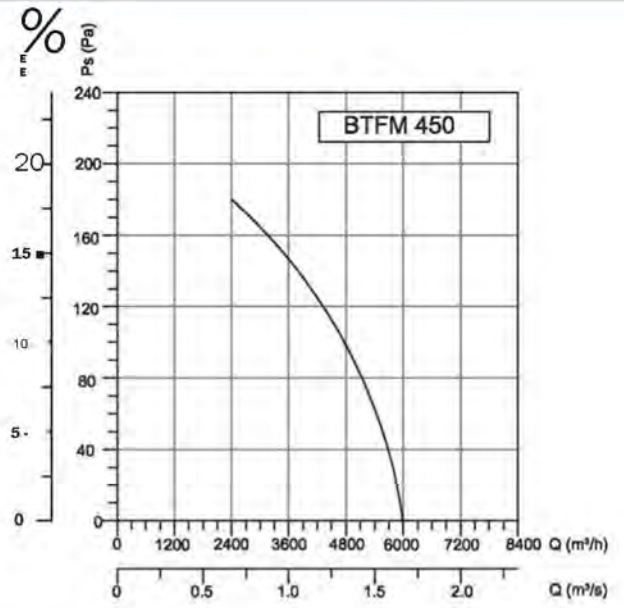
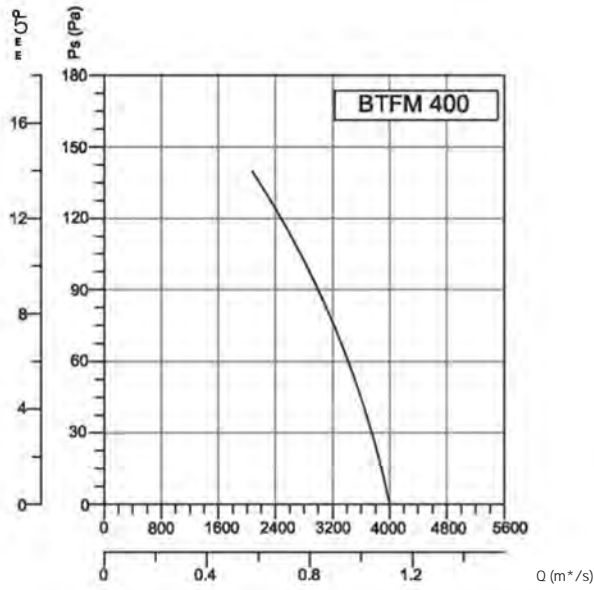

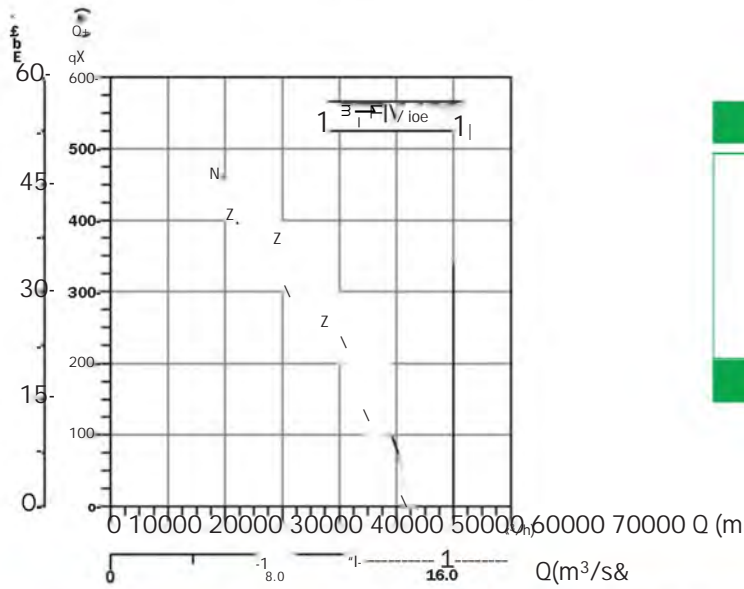
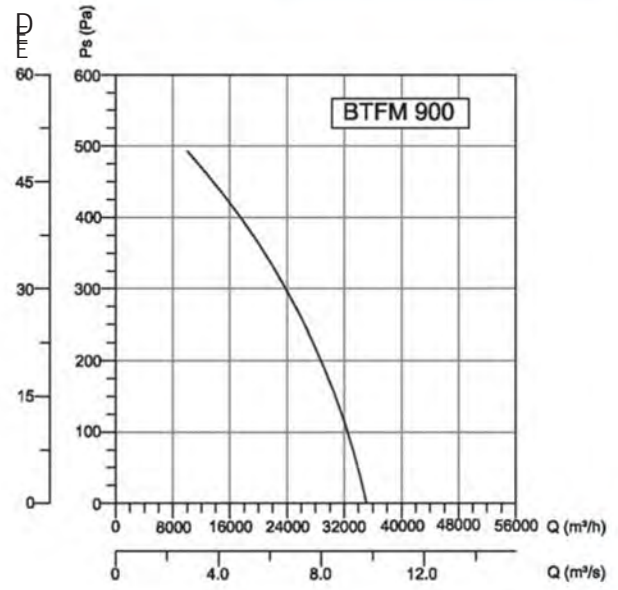
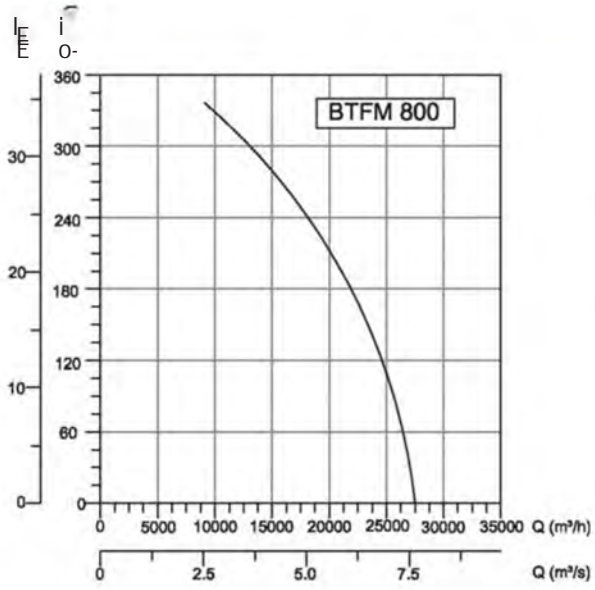

# RADIAL FANS

BASSF	OBR 140	OOES	BGSS
BDRAS	OBR 200	BRV/BRV-K	BORKA
BDRS	OBR 260	BRV-D	ORB
BPS 140-60	KMS/KTS	BRV-S	YB
BPS-B 140-60	BDS	BSK	
BPSB150100	BFC	BPF	
AORB	QES	ALO	

# RADIAL FANS



# BASSF

AC CENTRIFUGAL MOTORIZED IMPELLERS  
**Forward Curved**

High static pressure / laminar air flow / low noise level / powerful design / high efficiency / space saving due to their compact structure.

## Technical Drawings

### MATERIAL

### INSULATION CLASS

### DIRECTIVE

### SPEED CONTROL

### APPLICATION AREAS

- ⌘ Blade is made of galvanized sheet steel.
- ⌘ Class B and Class F
- ⌘ EN 60335, EN 60335-2-80
- ⌘ Speed can be adjusted using an optional controller.
- ⌘ Duct fans, centrifugal fans, machines cooling and boilers, elevator motor cooling, yacht air conditioning, electric board cooling, laboratories, residential and industrial areas etc.

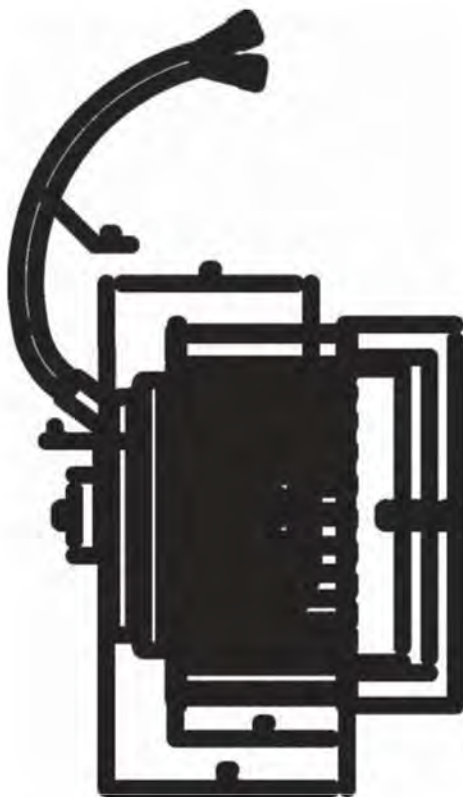

TYPE	A			D	E	F	G		L	M	N
BASSF 120-60	120	102	92	27	78	62	64	220	2	6	58
BASSF 140-60	140	124	92	27	80	59	71	220	2	6	58
BASSF 160-60	160	137	92	27	83	62	81	220	2	6	58

(E) Dimension is variable according to motor stator

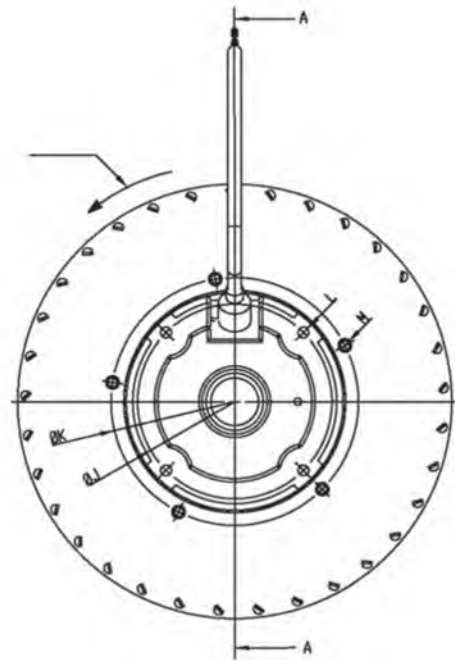
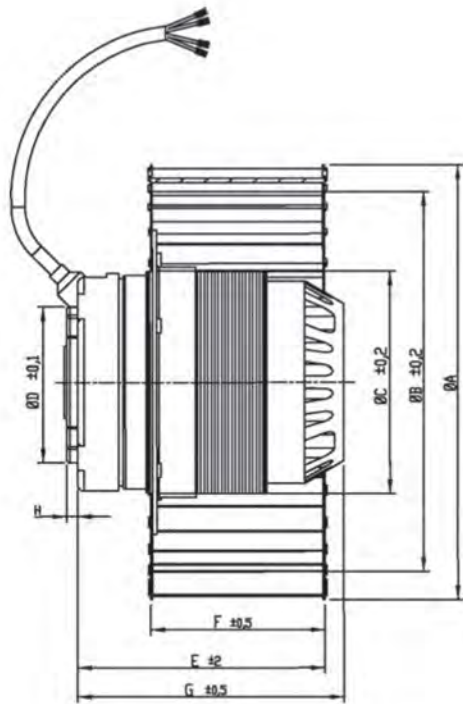

TYPE	A		D	E	F	G	H	J		L	M	
BASSF 200-80	200	172	102	74	114	80	122,5	5	89,5	120	M6	M5
BASSF 225-90	225	179	137	105	136	90	140	6	122	154	M6	M5
BASSF 250-100	250	203	137	105	164	98	160	6	122	154	M6	M5
BASSF 280-112	280	234	188	140	150	112	159	6	161,5	210	M10	M8
BASSF 315-125	315	259	188	140	163	125	159	6	161,5	210	M10	M8
BASSF 355-138	355	298	188	140	176	138	185	6	161,5	210	M10	M8

(E) Dimension is variable according to motor stator dim

TYPE	$v_{L-T^{\wedge}B}$	FREQUENCY	POWER	CURRENT	$(i)$	SPEED	AIR FLOW	SOUND PRESSURE LEVEL	WEIGHT
	V	Hz	W	(A)	1				
BASSF 120-60	230	50	80	0,33	2,5	2680	275	60	1,4
BASSF 140-60	230	50	120	0,5	4	2630	485	61	1,8
BASSF 160-60	230	50	150	0,6	5	2630	600	65	2,1
BASSF 200-80	230	50	200	0,9	6	1250	1000	53	12
BASSF 225-90	230	50	230	0,15	8	1400	1600	55	16
BASSF 250-100	230	50	295	2,1	14	1250	1900	58	19
BASSF 280-112	380	50	950	2,6	-	1350	2850	61	23
BASSF 315-125	380	50	1230	2,7	-	1280	4000	64	33
BASSF 355-140	380	50	2500	1,5	-	915	6000	70	40

# RADIAL FANS

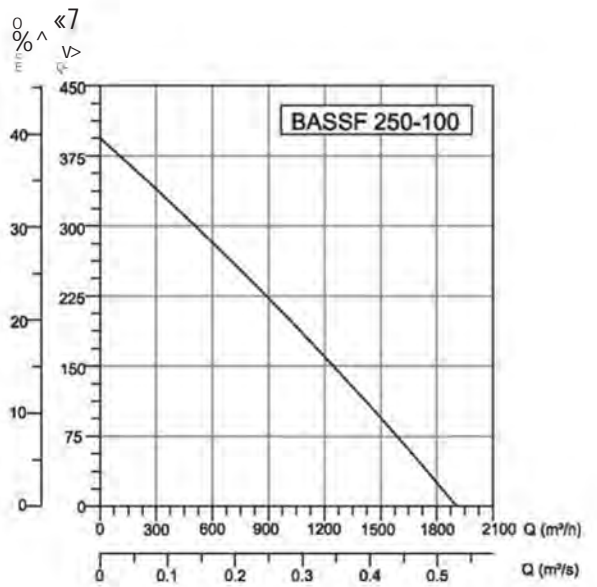
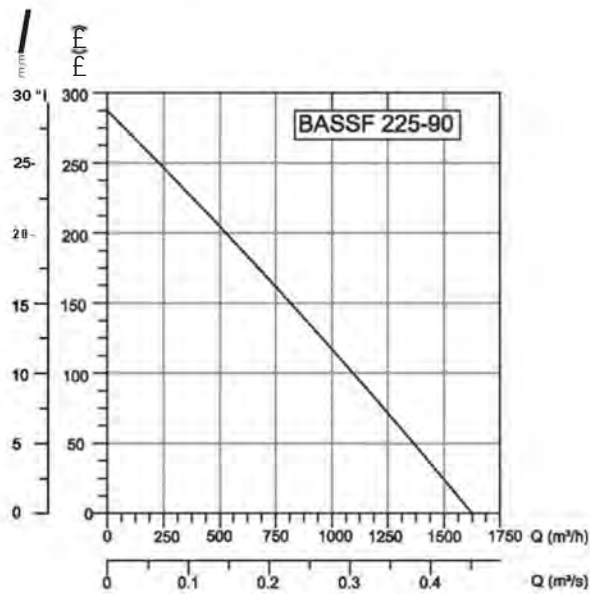
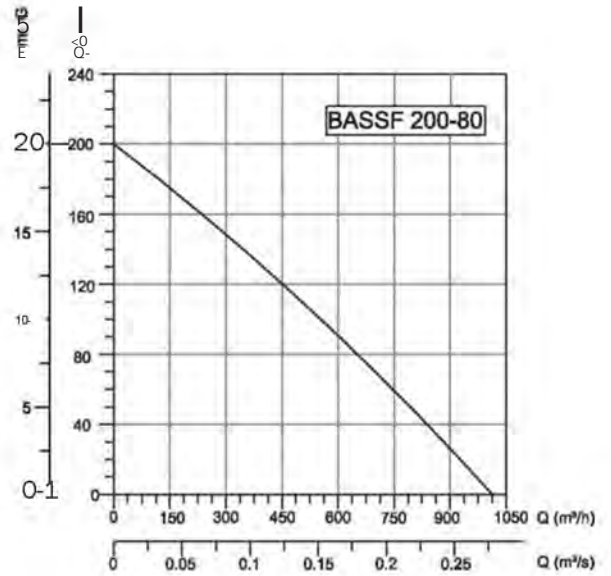
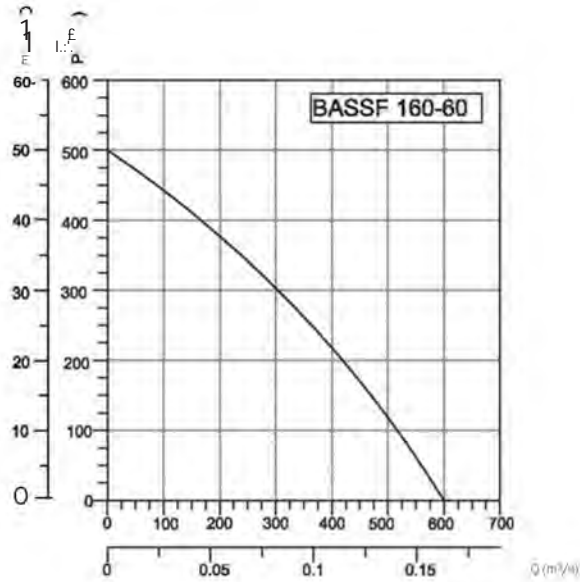
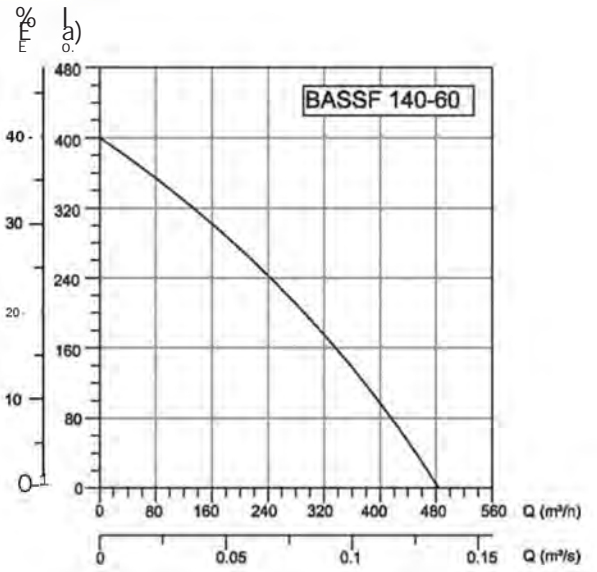
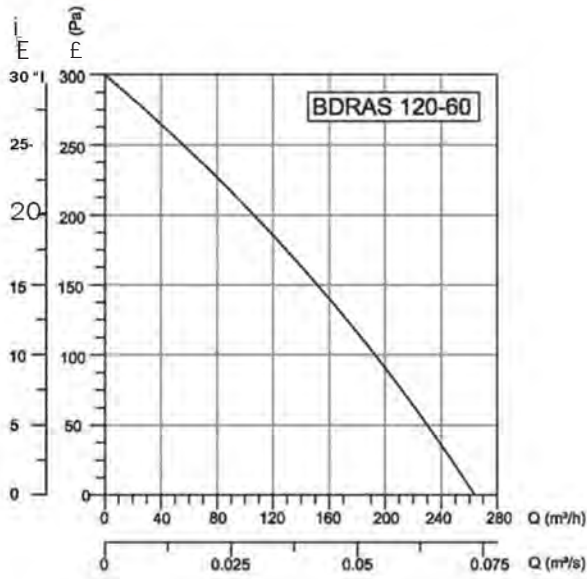



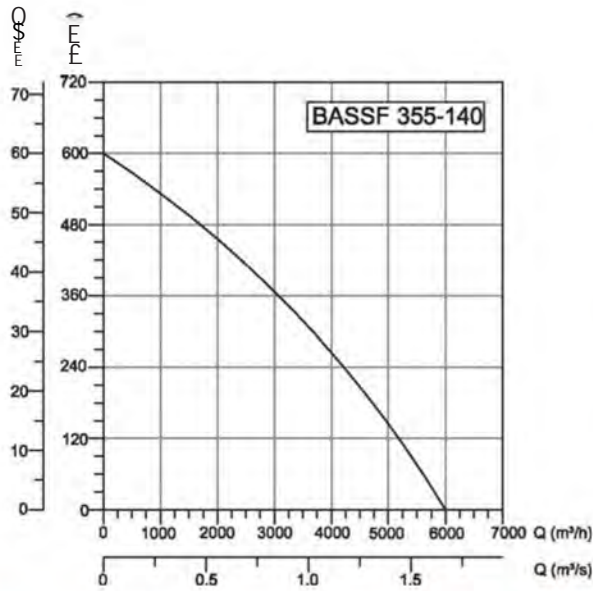
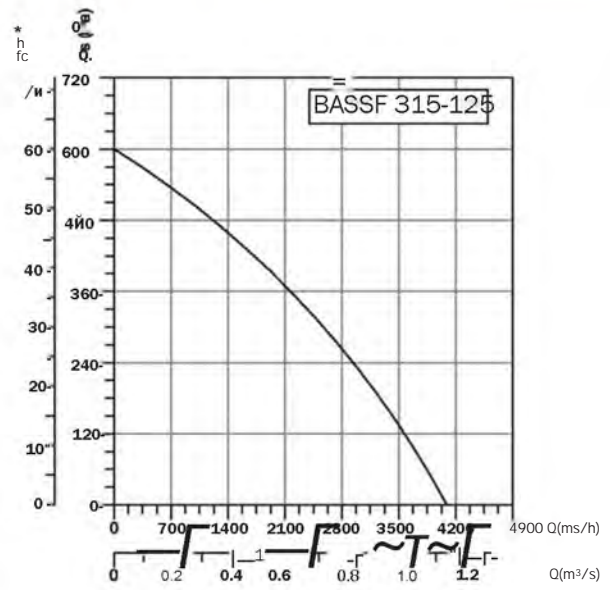
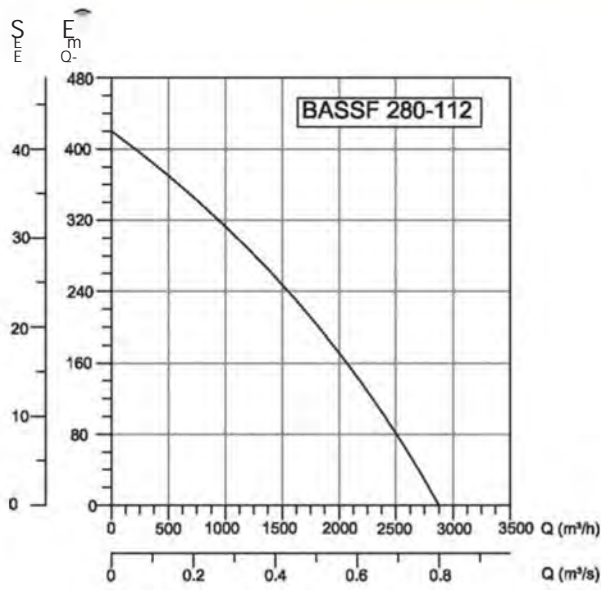

#### Accessories



BSC



BSC-F



## RADIAL FANS



# BDRAS

## AC CENTRIFUGAL BLOWERS Aluminum Body

Low noise, resistant housing structure, high pressure. Single Inlet BDRAS fans compact structure benefits space saving for various cooling and ventilation applications.

### Technical Drawings

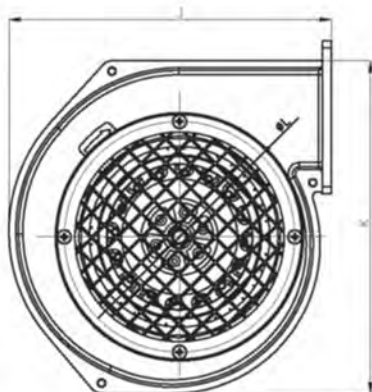
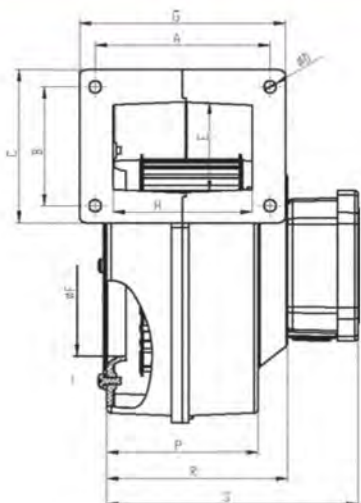

#### MATERIAL

- ; Casing is made of Aluminium, impeller is forward curved and made of galvanized sheet iron.

#### INSULATION CLASS

- ; Class

#### DIRECTIVE

- ; EN 60335-1, EN 60335-2-80

#### SPEED CONTROL

- ; Speed can be adjusted using an optional controller. (BSC-1/ BSC-2)

#### APPLICATION AREAS

- ; Perfect for industrial and commercial applications, especially local cooling applications and heating systems. Machines cooling, boilers, yacht air conditioning, DC motor cooling, plastic machines, sock machines, electric board cooling, laboratories, residential and industrial areas etc.

TYPE	A	B	C	D	E	F	G	H	J	K	L	P	R	S
BDRAS 85-40	66	58	68	5,5	42	63	76	56	117,5	127,5	84	80	-	120
BDRAS 108-50	96	66	83	6,5	50	87	115	76	159	183	118	82	-	122
BDRAS 120-60	99	67,5	88	6,5	49	103,5	118,5	80	190	184	132	87	104	145
BDRAS 140-60	123	84	125	6,5	78	110	154	79	197	203	144,5	100	110	151
BDRAS160-60	114	105	120	8	90	117,5	130	93,5	229	248	158	100	-	135

Dimensions are in (mm)

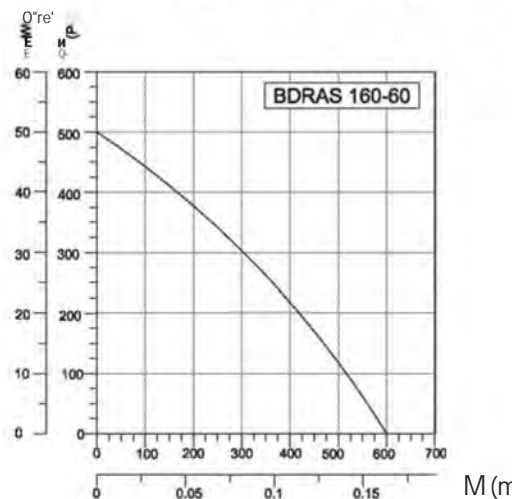
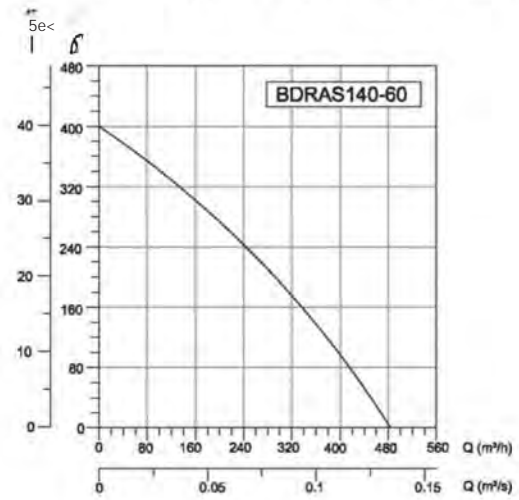
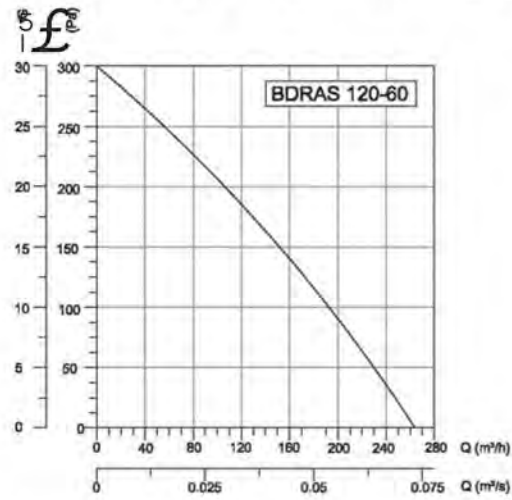
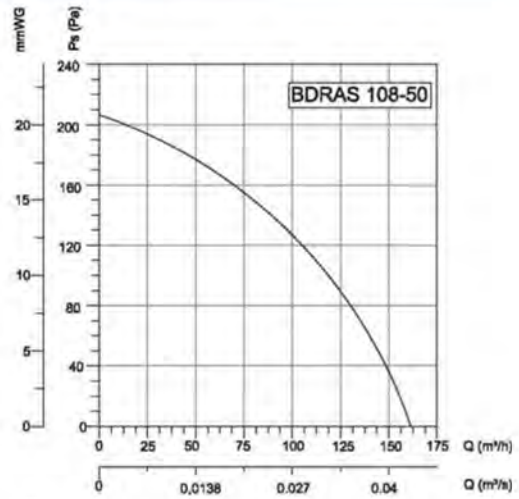
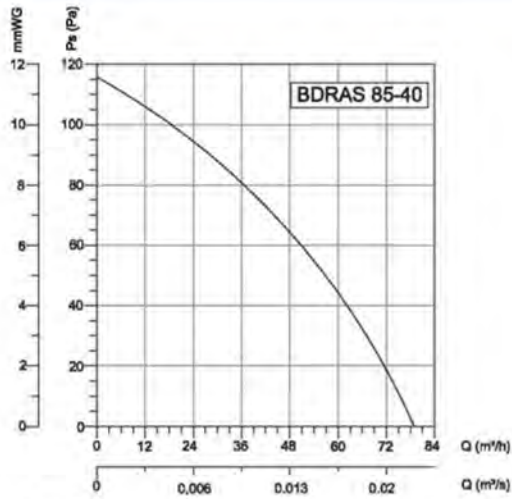

M (m³/s & M (m³/s &

TYPE	VOLTAGE	FREQUENCY	POWER	CURRENT	CAPACITOR	SPEED	AIR FLOW	SOUND PRESSURE LEVEL	WEIGHT
	V	Hz	W	(A)	(MF)	d/d	m³/h	dB(A)	kg
BDRAS 85-40	230	50	33	0,16	1	2355	80	53	1,1
BDRAS 108-50	230	50	42	0,2	1,5	1660	155	53	1,4
BDRAS 120-60	230	50	84	0,37	2,5	2450	275	60	2,5
BDRAS 140-60	230	50	137	0,6	4	2265	485	70	3
BDRAS 160-60	230	50	193	0,85	5	2100	600	72	3,9

## BDRAS FLANGE TYPES

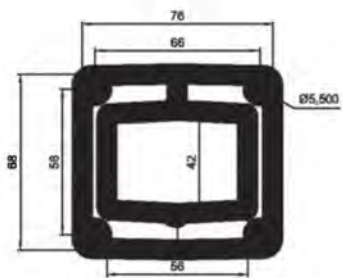

BDRAS 85-40

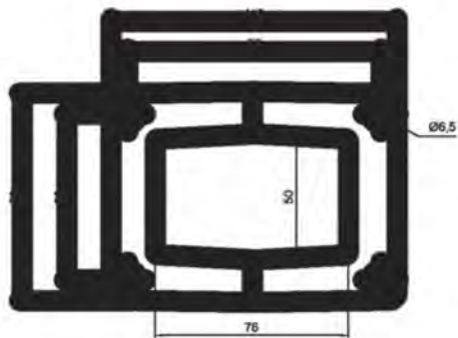

BDRAS 108-50

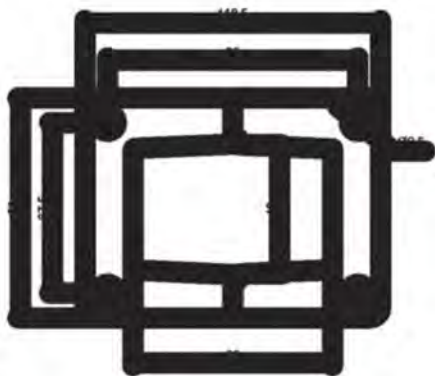

BDRAS 120-60

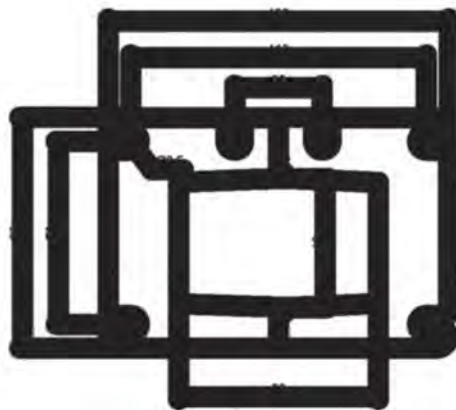

BDRAS 120-60

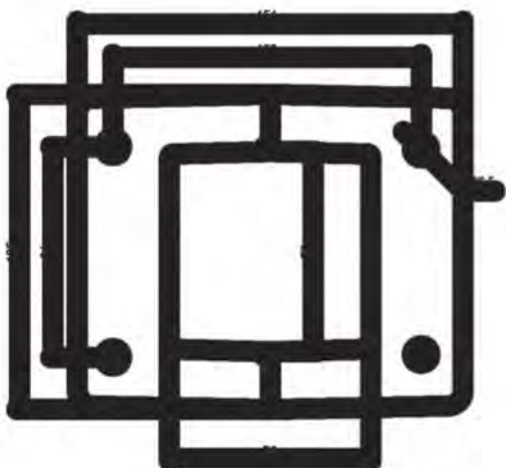

BDRAS 140-60



BDRAS 160-60



Accessories



m  
BSC



# RADIAL FANS



## BDRS

AC CENTRIFUGAL BLOWERS

Sheet Metal Body

BDRS Single Inlet blower's compact structure benefits space saving for various cooling and ventilation applications.

### Technical Drawings

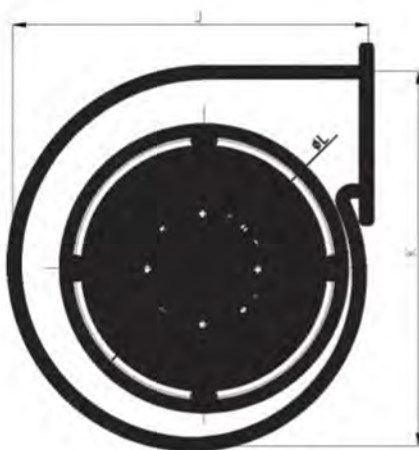
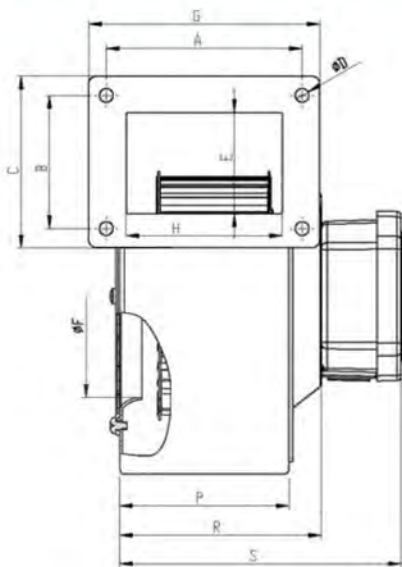

- MATERIAL : Housing is electrostatic powder coated sheet steel. Impeller is forward curved, galvanized.
- INSULATION CLASS : Class
- DIRECTIVE : EN 60335-1, EN 60335-2-80
- SPEED CONTROL : Speed can be adjusted using an optional controller. (BSC-1/ BSC-2)
- APPLICATION AREAS : The BDRS centrifugal fan series are perfect to use in industrial and commercial environments, mainly for local cooling applications, blowing in heating systems. Machines cooling, boilers, yacht air conditioning, dc motor cooling, plastic machines, sock machines, electric board cooling, laboratories, residential and industrial areas etc.



### Accessories



**BSC**

TYPE	A			D	E	F	G	H	J		L	P	R	S
BDRS 125-50	72	77	88	5	62	98	86	66	170	180	128	66	68	94
BDRS 120-60	98.5	69.5	100	6	67.5	97.5	115.5	81	173	183	133	83	93	134
BDRS 140-60	112	112	129.3	6.5	91.5	112	129	83.5	206	216	151	86	92	133
BDRS 160-60	112	112	129.3	6.5	92.5	130	129	84	270	260	165	94	100	141

Dimensions are in (mm)

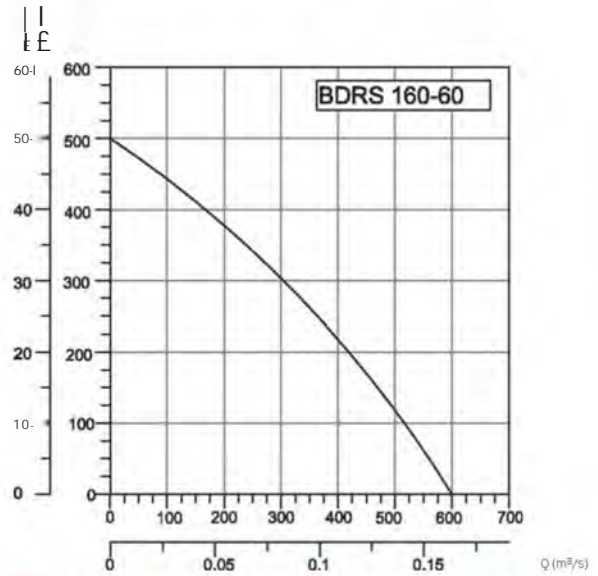
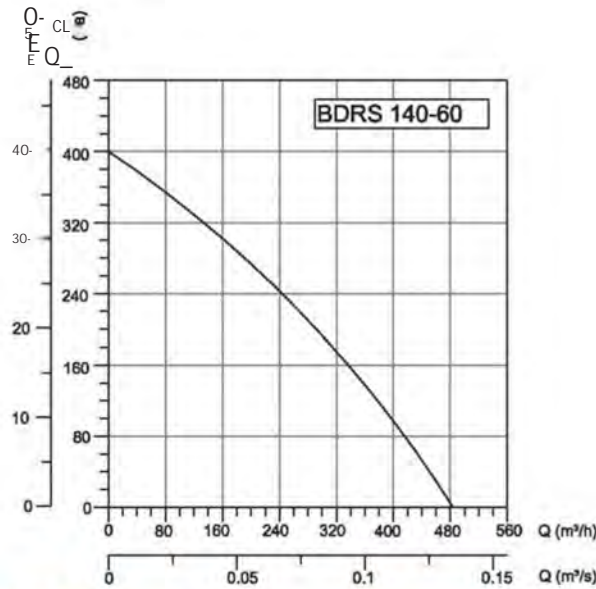
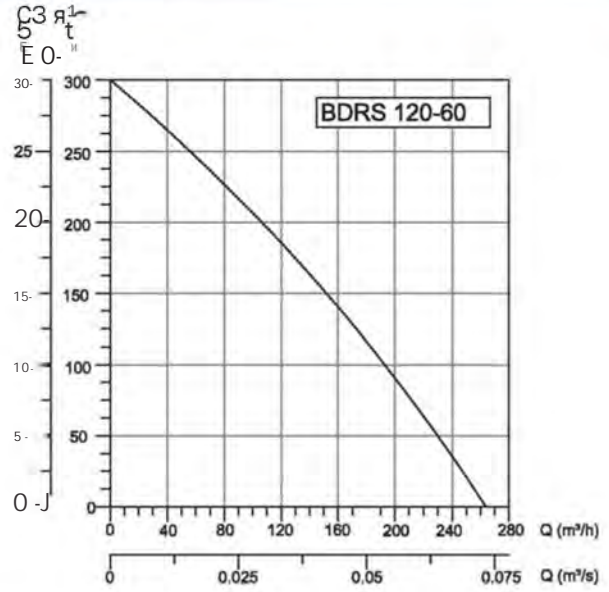
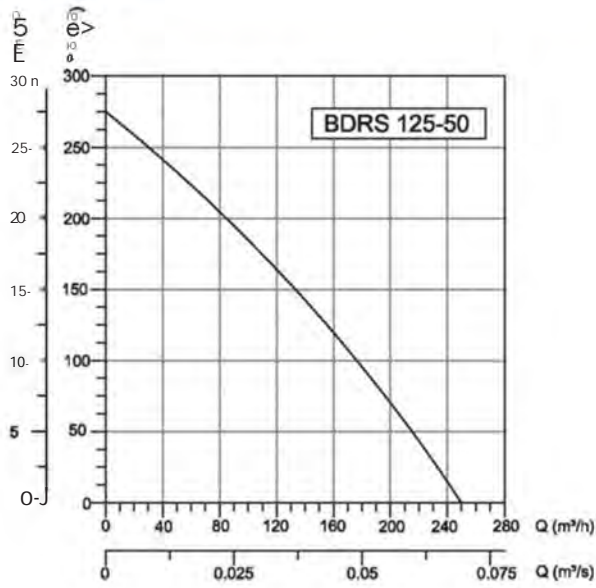

TYPE	VOLTAGE	FREQUENCY	POWER	CURRENT	CAPACITOR	SPEED	AIR FLOW	SOUND PRESSURE LEVEL	WEIGHT
	V	Hz	W	(A)	(μF)	d/d	m³/h	dB(A)	kg
BDRS 125-50	230	50	85	0,38	2,5	2285	250	65	2,1
BDRS 120-60	230	50	90	0,4	2,5	2325	275	66	2,3
BDRS 140-60	230	50	140	0,6	4	2215	485	70	2,9
BDRS 160-60	230	50	205	0,8	5	2000	600	74	4

# RADIAL FANS



# BPS 140-60

AC CENTRIFUGAL BLOWER

Plastic Housing

Plastic housing of Single Inlet BPS fan allows operating the fan where corrosive and inflammable airflow is subjected to put in operation.

## Technical Drawings

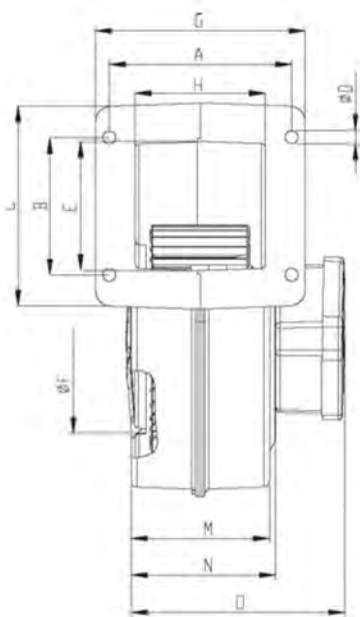
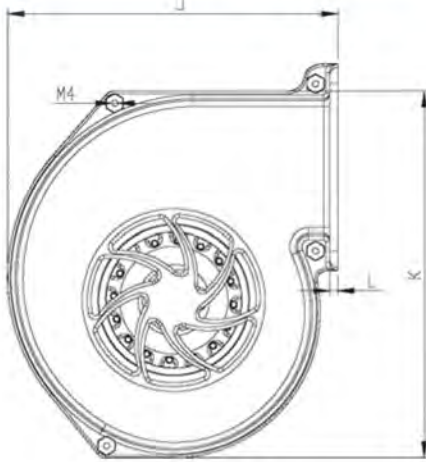

**MATERIAL** : Scroll housing is made of from injected white plastic. Both forward curved plastic or metal impeller is available.

**INSULATION CLASS** : Class

**DIRECTIVE** : EN 60335-1, EN 60335-2-80

**SPEED CONTROL** : Speed can be adjusted using an optional controller.

**APPLICATION AREAS** : Acetic environments, laboratories, residential areas, packing machines, yacht air conditioning, dc motor cooling, sock machines, industrial and commercial areas, etc.

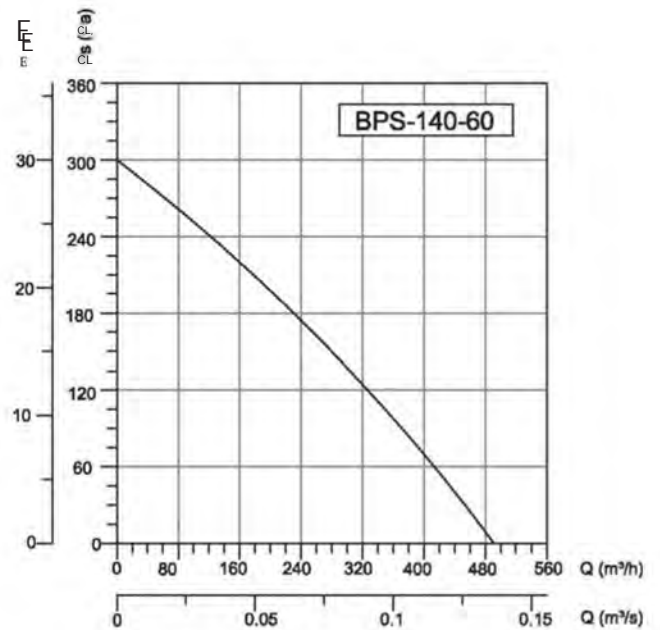

TYPE	VOLT ^ E	FREQUENCY	CL WER	CU ENT	/	SPEED	$\frac{Q}{V}$	$\frac{Q}{V}$	WEIB x T
	V Hz W (A) (MF)	d/d m <sup>3</sup> /hdB(A)kg							
BPS 140-60	230	50	113	0,5	4	2590	500	702	

TYPE	A		D	E	F	G	H	J		L	M	N	O	
BPS 140-60	110.5	83.5	123	6	76	110	128.5	79.5	201	225	5	85.5	90	130

Dimensions are in (mm)



# BPS-B 140-60

AC CENTRIFUGAL BLOWER

Plastic Body



Plastic housing of Single Inlet BPS-B fan allows operating the fan where corrosive and inflammable airflow is subjected to put in operation,

- MATERIAL: Scroll Housing made of plastic, Forward curved impeller is sheet metal,
- INSULATION CLASS: Class
- DIRECTIVE: EN 60335-1, EN 60335-2-80
- SPEED CONTROL: Speed can be adjusted using an optional controller,
- APPLICATION AREAS: In Heat Exchangers, Acetic environments, laboratories, residential areas, packing machines, yacht air conditioning, DC motor cooling, sock machines, industrial and commercial areas, etc,

## Technical Drawings

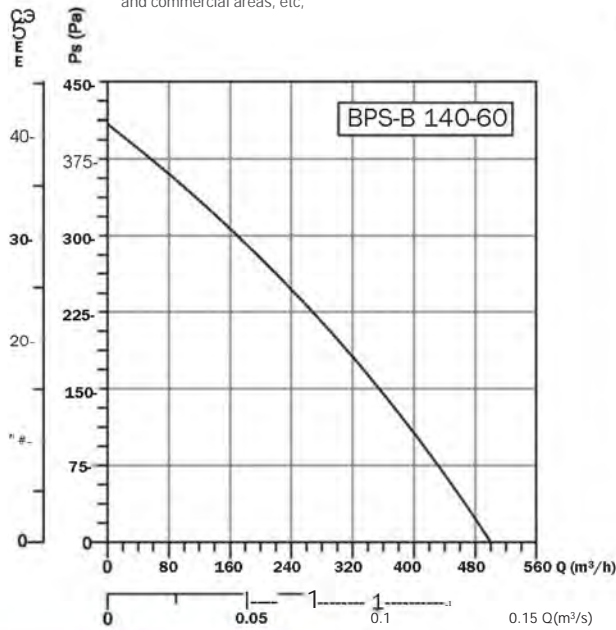
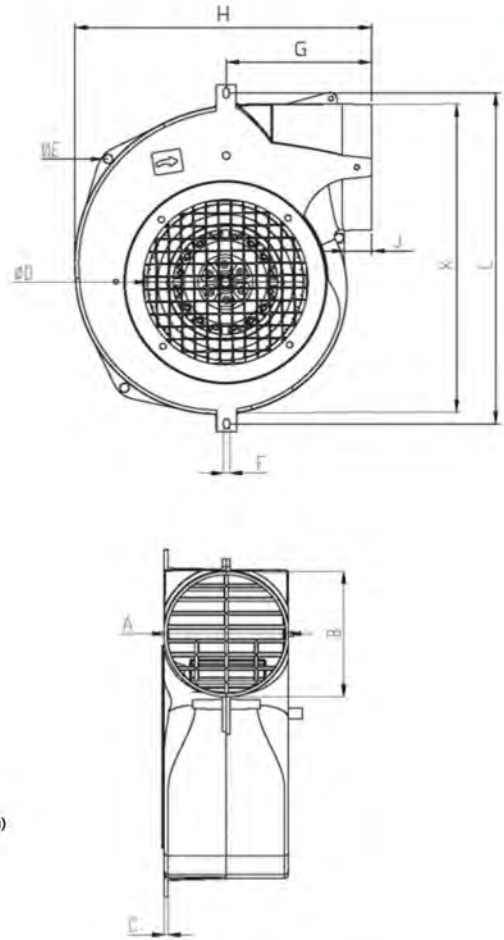

## Accessories



BSC

TYPE	VOLTAGE	FREQUENCY	5	CURRENT	1	SPEED	AIR FLOW	SOUND PRESSURE LEVEL	WEIGHT
	V	Hz	α	(A)	(MF)	d/d	m³/h	dB(A) kg	
BPS-B 140-60	230	50	125	0,56	4	2460	500	652,2	

TYPE	A			D	E	F	G	H	J	L
BPS-B 140-60	96	100	3	126	7	5	113	239	22 246	264

# RADIAL FANS



# BPS-B 150-100

AC DOUBLE INLET CENTRIFUGAL BLOWER  
Plastic Housing

BPS-B 150-100 double inlet fans are usually used for cooker hoods. They are preferred for wet and oily environments.

## Technical Drawings

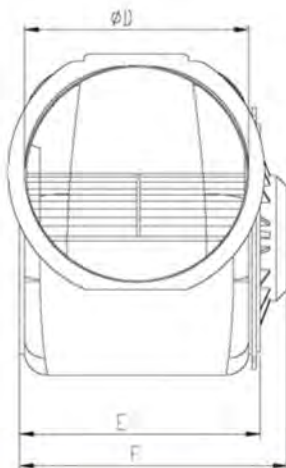
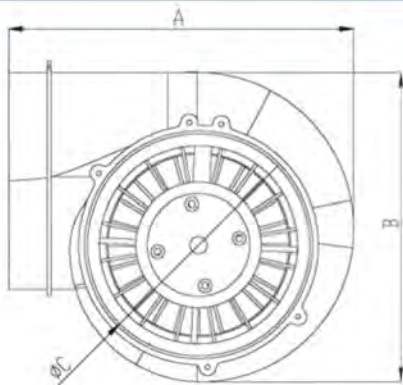

- MATERIAL : Housing is made of plastic. Forward curved fan is also made of plastic.
- INSULATION CLASS : Class
- DIRECTIVE : EN 60335-1, EN 60335-2-80
- SPEED CONTROL : Speed can be adjusted using an optional controller.
- APPLICATION AREAS : Cooker Hoods, laboratories, residential areas, industrial areas etc.

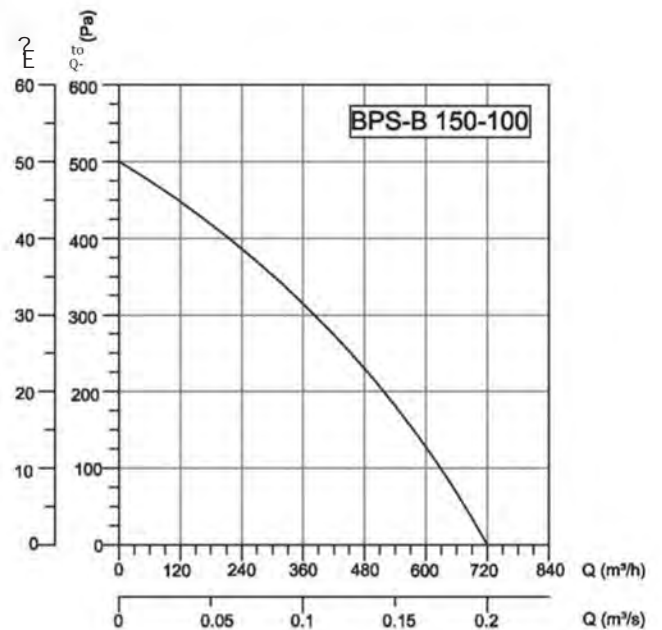

## Accessories



**BSC**

TYPE	V	Hz	W (A)	(MF)	d/d	CAPACITORS	CL	FLOW	LEVEL	kg
BPS-B 150-100	230	50	225	1	5	1930	720	65	2,6	

TYPE	A	D	E	F
BPS-B 150-100	241	217	156	150

Dimensions are in (mm)



# AOR

AC DIRECT DRIVE CENTRIFUGAL BLOWER

Metal Body



AORB fan's compact structure benefits space saving for various cooling and ventilation applications.

- MATERIAL**
  - Casing is made of electrostatic sheet metal, impeller is made of forward curved galvanized sheet metal.
- INSULATION CLASS**
  - Class
- DIRECTIVE**
  - EN 60335-1, EN 60335-2-80
- SPEED CONTROL**
  - Speed can be adjusted using an optional controller.
- APPLICATION AREAS**
  - The AORB centrifugal fan is perfect for use in industrial and commercial environments, mainly for local cooling applications, blowing in heating systems etc.

## Technical Drawings

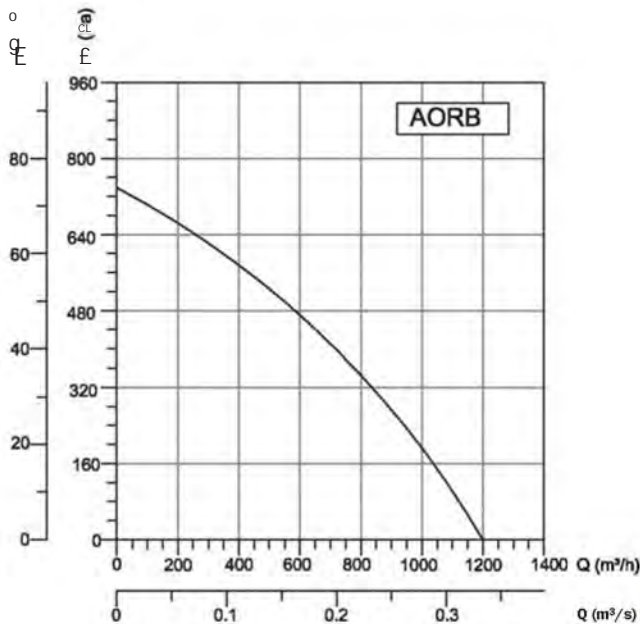
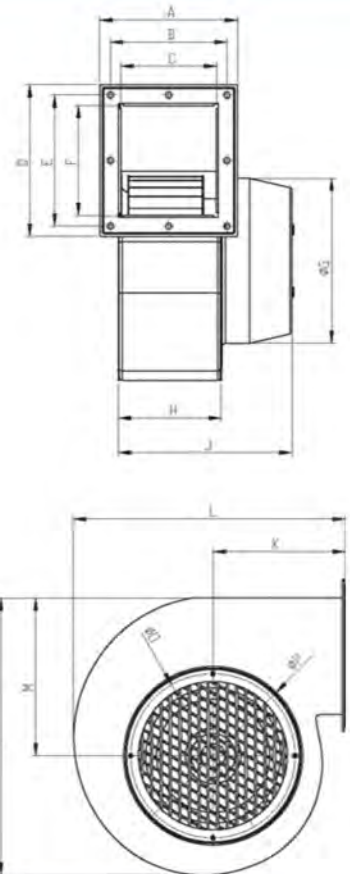

## Accessories



**BSC**

TYPE	VOLTAGE	FREQUENCY	CURRENT	CAPACITANCE	SPEED	AIR FLOW	SOUND PRESSURE LEVEL	WEIGHT
AORB	230	50	605	2,8	8	2750	1200	70

TYPE A	B	C	D	E	F	G	H	I	J	K	L	M	N	O	P
AORB	150	125	105	163	139	120	174	109	185	142	290	170	298	143	186

Dimensions are in (mm)

# RADIAL FANS



# OBR 140

AC CENTRIFUGAL FANS

Single Inlet

OBR 140 works at higher temperatures due to out of airflow motor location. Forward curved impellers suit higher pressure points.

- MATERIAL : Housing is made of electrostatic powder coated sheet metal, forward curved impeller is made of galvanized sheet metal.
- INSULATION CLASS : Class
- DIRECTIVE : EN 60335-1, EN 60335-2-80
- SPEED CONTROL : Speed can be adjusted using an optional controller.
- APPLICATION AREAS : Factories, depots, dyehouses, plants, machines etc. likely dusty places where dust and heat must be circulated.

## Technical Drawings

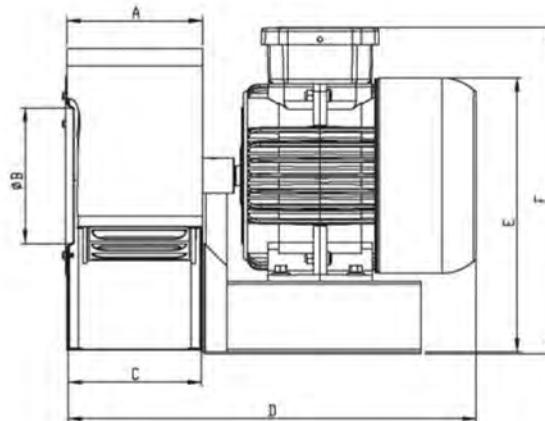
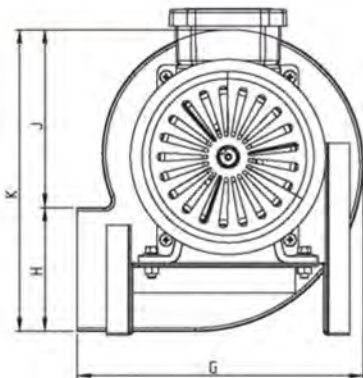

TYPE	VOLTAGE V	FREQUENCY Hz	POWER KW	CURRENT (A)	CAPACITOE (MF)	SPEED d/d	AIR FLOW m <sup>3</sup> /h	SOUND PRESSURIE LEVEL dB(A)	WEIGHT kg
OBR 140M-2K	230	50	225	1,2	8	2920	1100	65	7,2

TYPE	A	D	E	F	G	H	J			
OBR 140M-2K	103	106	102	294	200	240	204	91	125	216

Dimensions are in (mm)

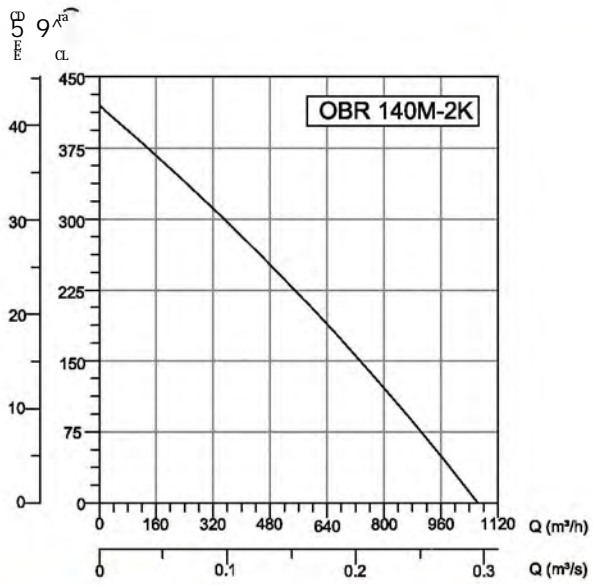

# RADIAL FANS



# OBR 200

AC CENTRIFUGAL FANS

Single Inlet

OBR 200 works at higher temperatures due to out of airflow motor location. Forward curved impellers suit higher pressure points.

**MATERIAL** : Housing is made of electrostatic powder coated sheet steel. Forward curved impeller is made of galvanized steel.

**INSULATION CLASS** : Class

**DIRECTIVE** : EN 60335-1, EN 60335-2-80

**SPEED CONTROL** : Speed can be adjusted using an optional controller.

**APPLICATION AREAS** : Factories, depots, dyehouses, industrial iron machines, plastic and packing machines etc. likely dusty places where dust and heat must be circulated, and cooling systems.

## Technical Drawings

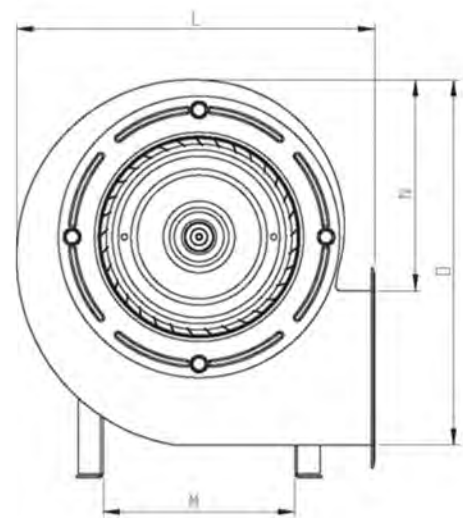
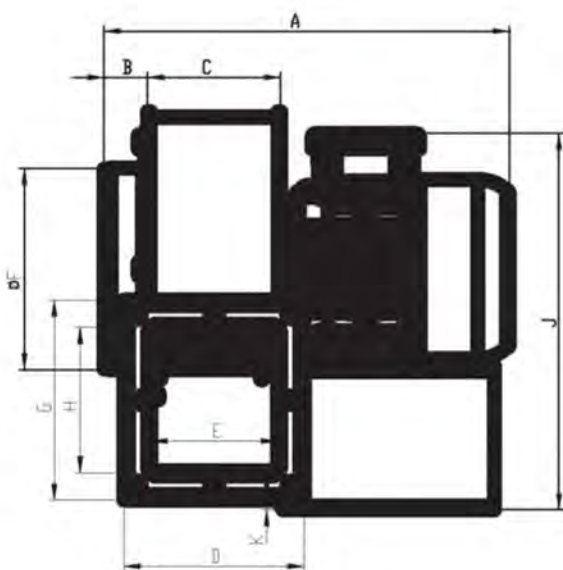

TYPE	A	B	C	D	E	F	G	H	J	L	M	N	O
OBR 200	322	34	109	146	102	163	161	115	310	17	288	150	170 295

Dimensions are in (mm)

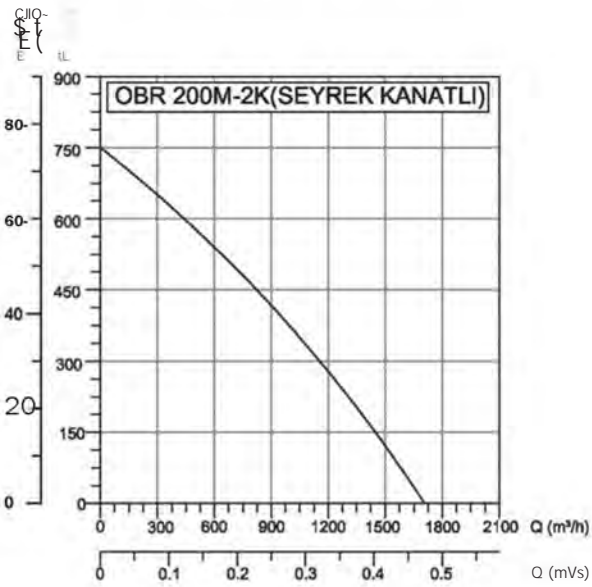
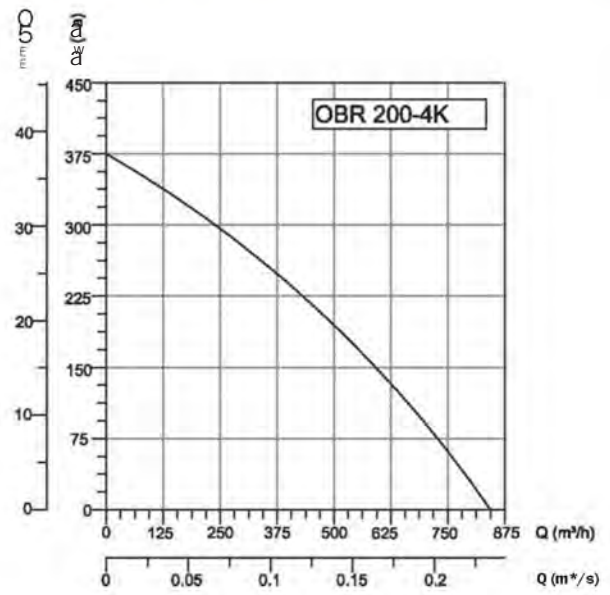
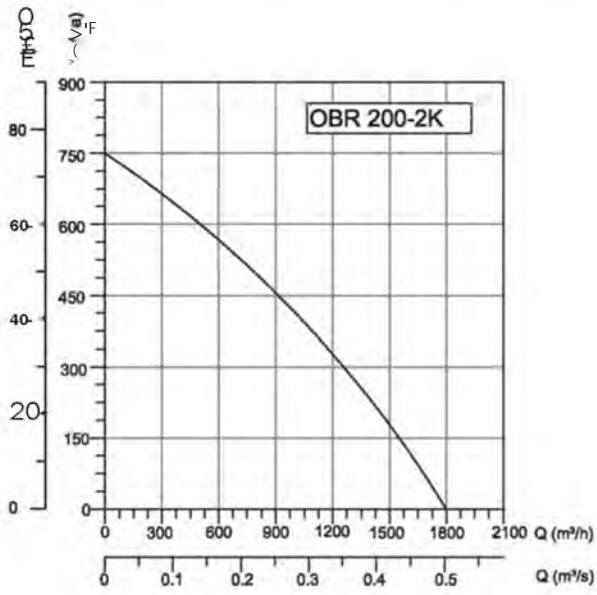

Accessories



TYPE	V Hz	W	(A)	( d/d m³/h	dB(A) kg				
OBR 200M-2K	230	50	580	2,6	8	2770	1800	65	9
OBR 200M-4K	230	50	190	1	8	1450	850	60	8,4
OBR 200M-2K (Seyrek Kanatli)	230	50	260	1,5	8	2900	1700	65	9,3
OBR 200T-2K	380	50	140	0,7	-	2960	1800	70	8,3
OBR 200T-4K	38.	50	190	0,9	-	1465	850	65	8,4

# RADIAL FANS



# OBR 260

AC CENTRIFUGAL FANS  
Single Inlet

OBR 260 works at higher temperatures due to out of airflow motor location. Forward curved impellers suit higher pressure points.

## Technical Drawings

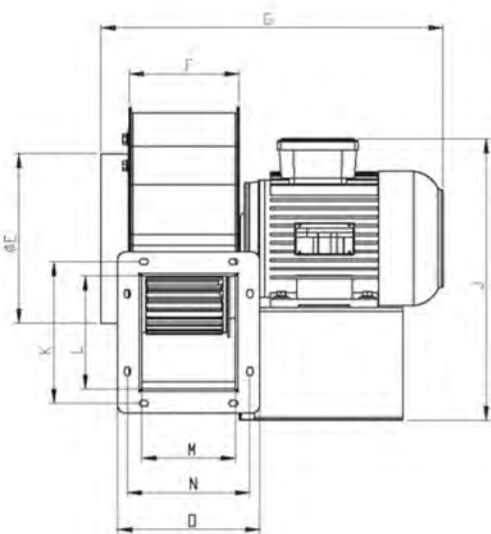
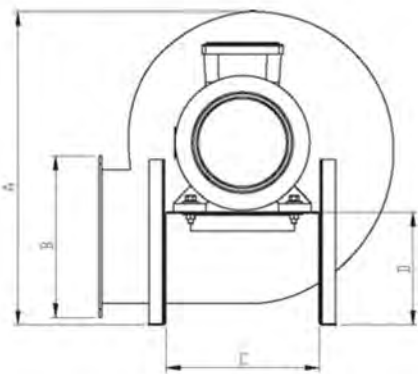

- MATERIAL : Housing is made of electrostatic powder coated sheet metal, forward curved impeller is made of galvanized sheet metal.
- INSULATION CLASS : Class
- DIRECTIVE : EN 60335-1, EN 60335-2-80
- SPEED CONTROL : Speed can be adjusted using an optional controller.
- APPLICATION AREAS : Factories, depots, dyehouses, industrial iron machines, olive election machines, plastic and packaging machines etc. likely dusty places where dust and heat must be circulated, and cooling systems.

## Accessories



TYPE	A			D	E	F	G	J		L	M	N	O
OBR 260	361	194	155	119	197	128	405	327	162	137	115	140	163

Dimensions are in (mm)



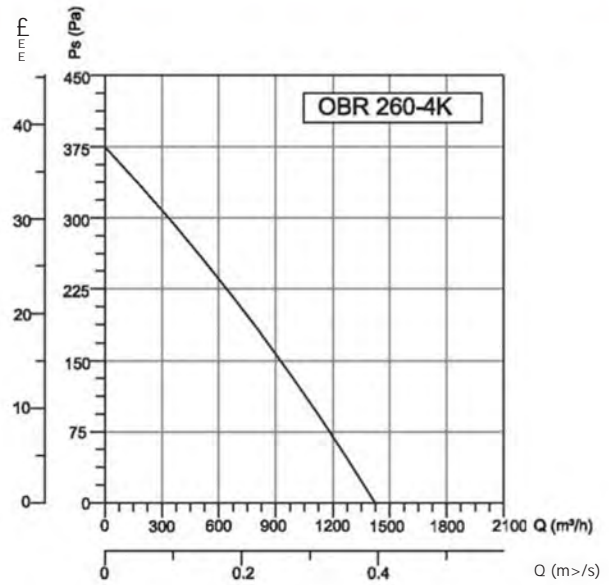
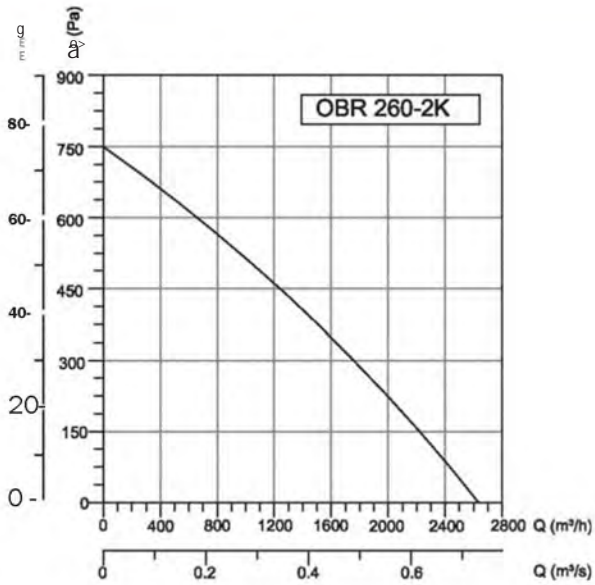

TYPE	VOLTAGE	FREQUENCY	POWER	00...ε>	U* t ^ p^	SPEED	AIR FLOW	SOUND pressur: LEVEL	χ g
	V	Hz	w	(A)	(MF)	d/d	m³/h	dB(A)	kg
OBR 260M-2K	230	50	1500	9	25	2730	2700	80	11,2
OBR 260M-4K	230	50	330	1,5	10	1375	1450	75	9,5
OBR 260T-2K	380	50	1700	2,7	11	2750	2700	80	12,8
OBR 260T4K	380	50	290	0.82	-	1380	1450	70	9,8



# RADIAL FANS



## KMS - KTS

AC CENTRIFUGAL FANS

Single Inlet

Due to motor location is out of airflow, higher temperature air can be transferred. Direct coupled motor structure (Single Phase / Three Phase)

### Technical Drawings

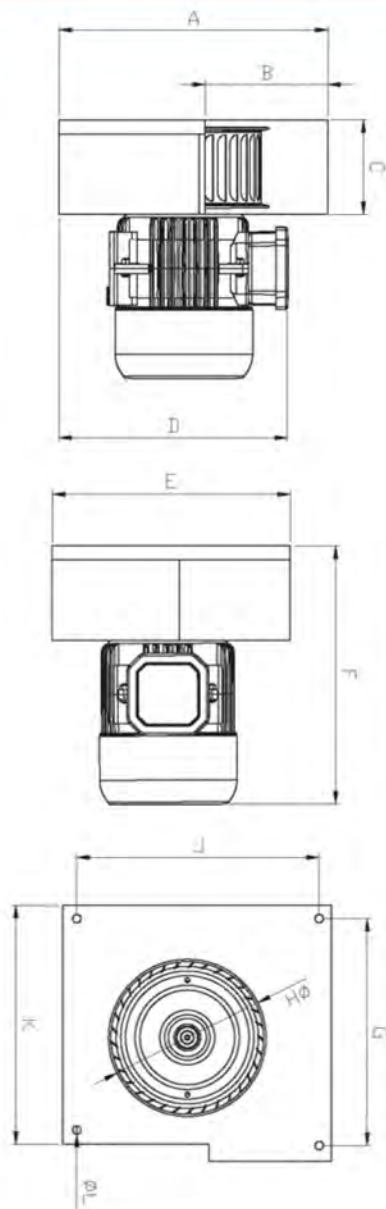

MATERIAL

- Housing is made of electrostatic powder coated sheet steel, forward curved impeller is galvanized sheet metal,

INSULATION CLASS

- Class

DIRECTIVE

- EN 60335-1, EN 60335-2-80

SPEED CONTROL

- Speed can be adjusted using an optional controller,

APPLICATION AREAS

- Factories, steam optioned iron machines, packaging machines, olive election machines, ventilation of small areas etc,

TYPE	VOLT $\sqrt{3}$ E	FREQUENCY	W OC q.	NT	f	PEED	AIR FLOW	WIND BE-1 EV-L	WEIGHT
	V	Hz	w (A)		(	d/d	m <sup>3</sup> /h	XT	kg
KMS	230	50	460	2,6	8		27501500	-	7,5
KTS	380	50	4601,1		-		2870 1500 75 7,5		

TYPE	A			D	E	F	G	H	J		L
KMS-KTS 278	114		106	231	248	282	198	178	235	238	8

Dimensions are in (mm)

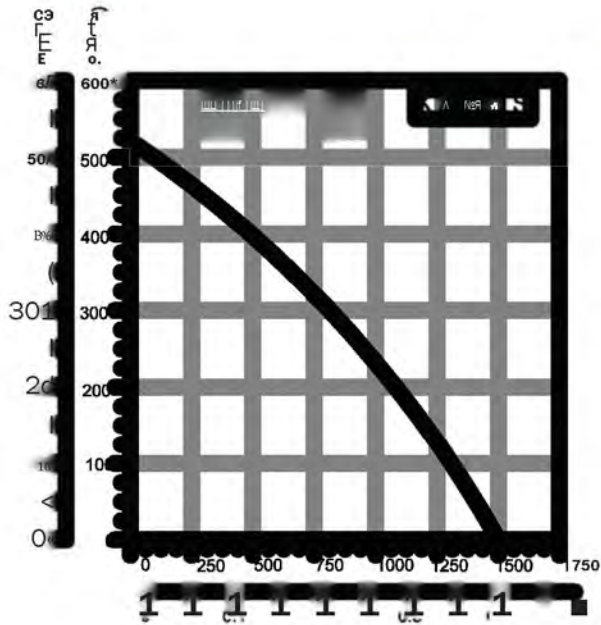

### Accessories



BSC



# RADIAL FANS



## BDS

### AC CENTRIFUGAL BLOWERS Aluminum Housing

Resistant housing structure, high pressure. Single Inlet compact structure benefits space saving for various cooling and ventilation applications.

#### Technical Drawings

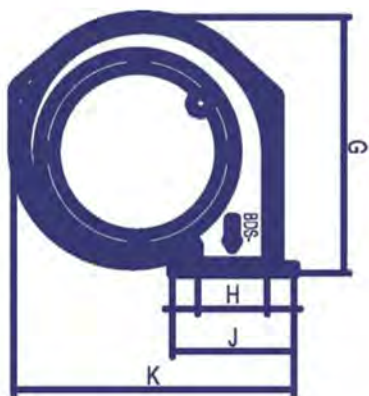
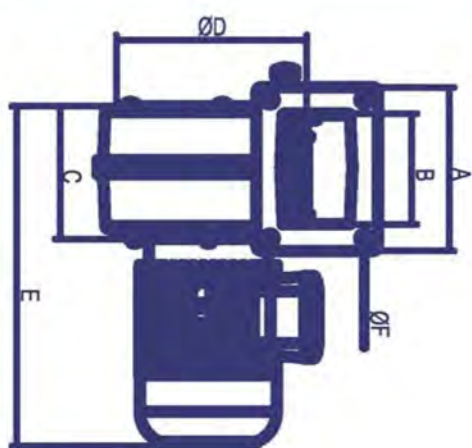

MATERIAL

INSULATION CLASS

DIRECTIVE

SPEED CONTROL

APPLICATION AREAS

: Housing is made of aluminum injection;  
impeller is forward curved, galvanized.

: Class F

: EN 60335-1, EN 60335-2-80

: Speed can be adjusted using an optional controller.

: The BDS centrifugal fan series are perfect for use in industrial and commercial environments, mainly for local cooling applications, blowing in heating systems.

Machines cooling, boiler, plastic machines, sock machines, heating with electrical heater applications, jewelry industry etc.

#### Accessories



BSC-F

TYPE	A	B	C	D	E	F	G	H	J	K
BDS 1	130	90	110	140	315	10	215	60	110	220
BDS 2	160	115	137	160	324	10	290	105	160	280
BDS 3	160	115	137	180	370	10	303	105	160	290
BDS 4	187	127	148	225	374	10	370	105	160	310
BDS 5	203	158	165	250	435	10	415	105	203	430
BDS 6	203	158	165	268	435	10	415	105	203	450
BDS 7	240	170	230	300	605	10	505	105	240	510
BDS 8	240	170	230	315	605	10	505	105	240	530

Dimensions are in (mm)

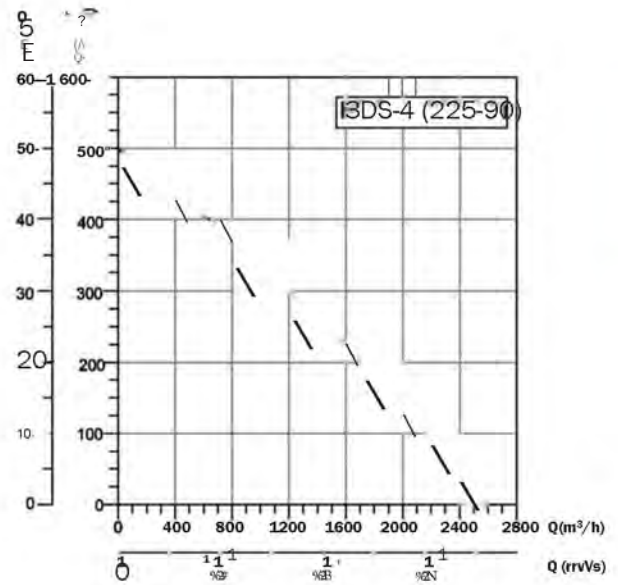
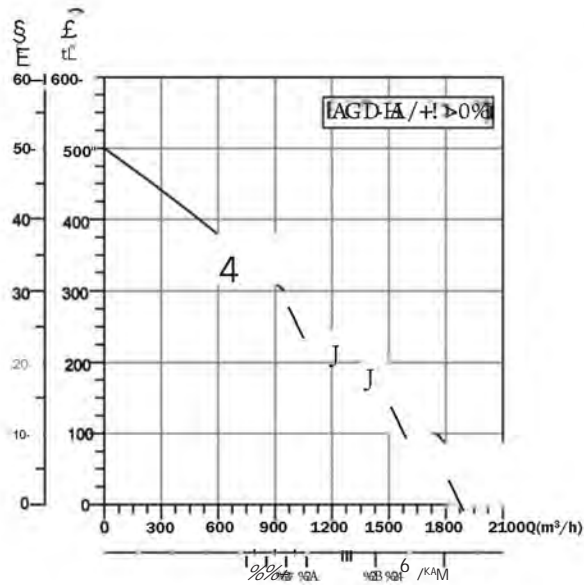
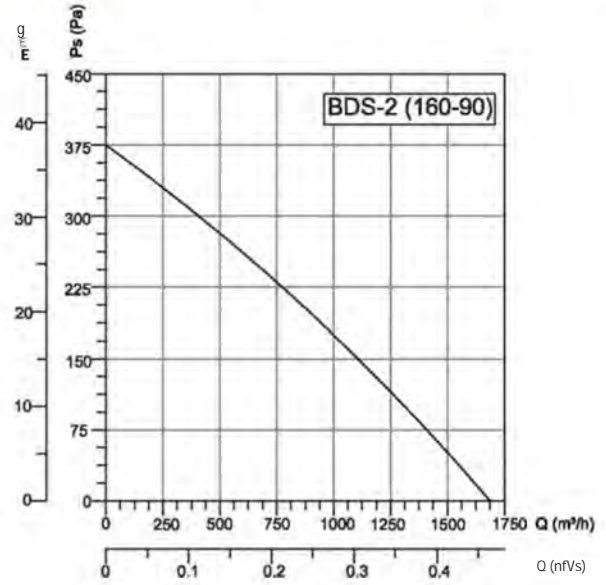
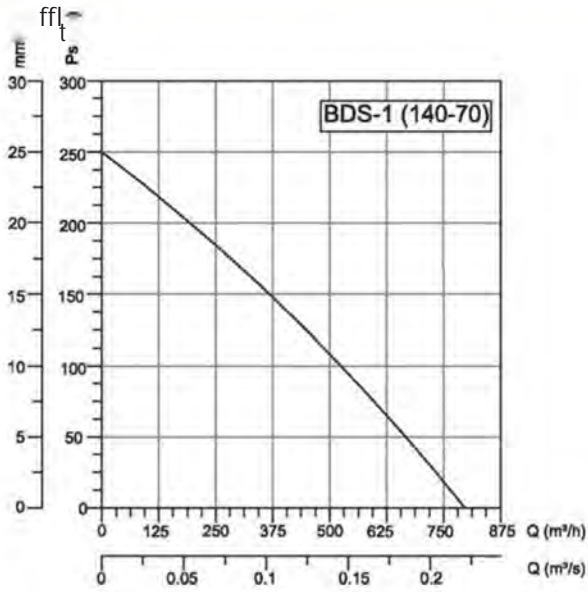

TYPE	VOLTAGE	FREQUENCY	$\alpha$	CURRENT	SPEED	AIR FLOW	SOUND PRESSURE LEVEL	WEIGHT
	V	Hz	KW	(A)	d/d	m³/h	dB(A)	kg
BDS 1M / BDS 1T (140-70)	230/380	50	0,25	1,6/0,67	2600	800	55	9
BDS 2M / BDS 2T (160-90) 230/380		50	0,37	2,5/1,05	2870	1700	60	11
BDS 3M / BDS 3T (180-90) 230/380		50	0,55	3,5/1,27	2800	2100	70	13
BDS 4M / BDS 4T (225-90) 230/380		50	0,75	5/1,8	2800	2600	73	18
BDS 4M / BDS 4T (225-102) 230/380		50	1	7/2,4	2800	3200	75	19
BDS 5M / BDS 5T (250112) 230/380		50	1,5	9,8/3,3	2900	3700	80	25
BDS 6M / BDS 6T (268-112) 230/380		50	2,2	13,5/4,65	2800	4650	55	31
BDS 7T (300112)	380	50	4	6	2800	6200	60	43
BDS 8T (315-112)	380	50	5	7,8	2800	8400	69	48

# RADIAL FANS

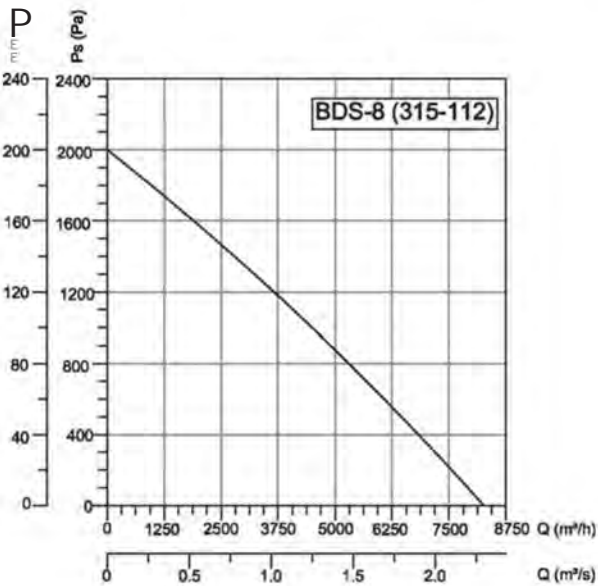
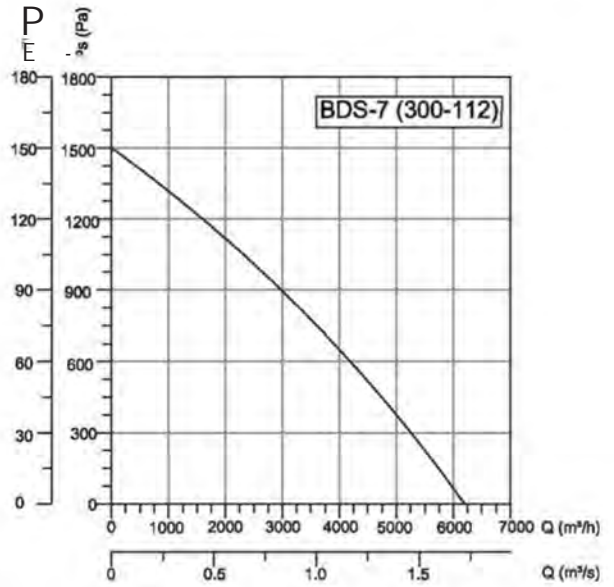
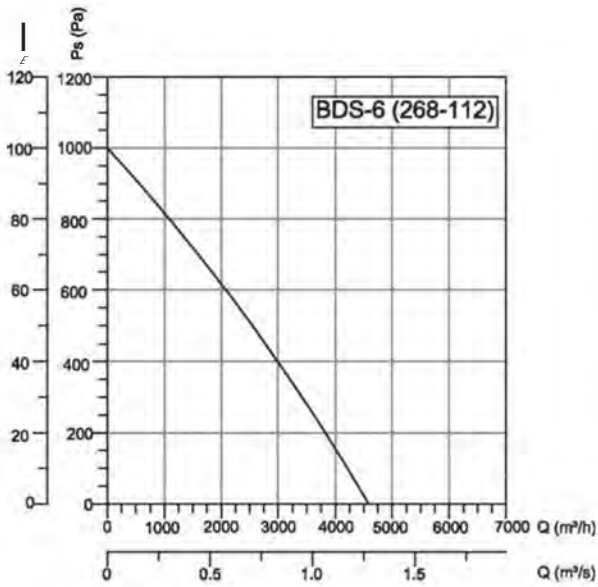
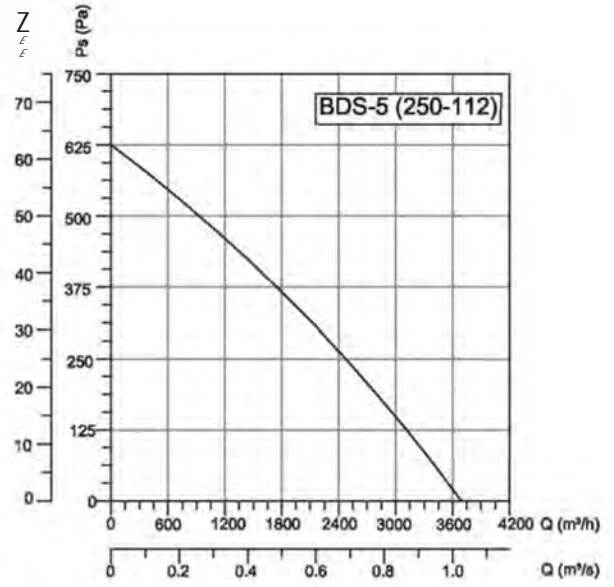
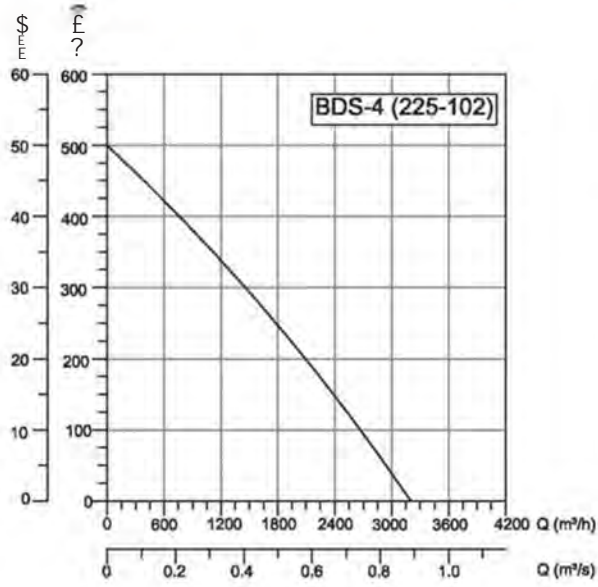



# RADIAL FANS



# BFC

AC FANCOIL FANS

Forward Curved

BFC (double inlet centrifugal) fans work at high efficiency and low noise.

## Technical Drawings

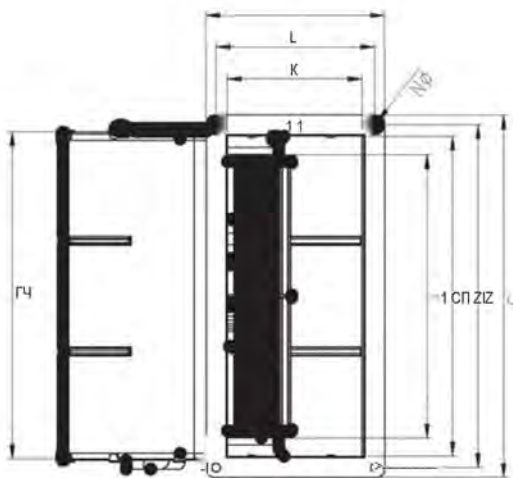
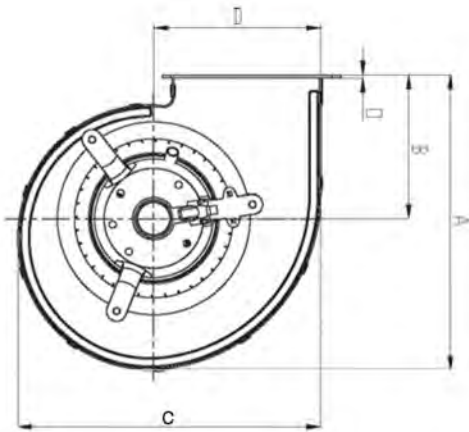

- MATERIAL : Housing is made of galvanized sheet metal, impeller is forward curved and made of galvanized sheet metal.
- INSULATION CLASS : Class
- DIRECTIVE : EN 60335-1, EN 60335-2-80
- SPEED CONTROL : Speed can be adjusted using an optional controller.
- APPLICATION AREAS : Atfancoil units, local cooling applications, low noise asked air circulation applications.

TYPE	V	Hz	W	(A)	(MR)	d/d	m <sup>3</sup> /h	dB(A)	kg
BFC 133-4K	230	50	85	0,37	2,5	1180	800	45	4,7

TYPE	A	B	C	D	E	F	G	H	I	J	K	L	M	N	O
BFC 133-41	208	101	214	118	231	200	226	242	256	95	112	126	06	2	

Dimensions are in (mm)



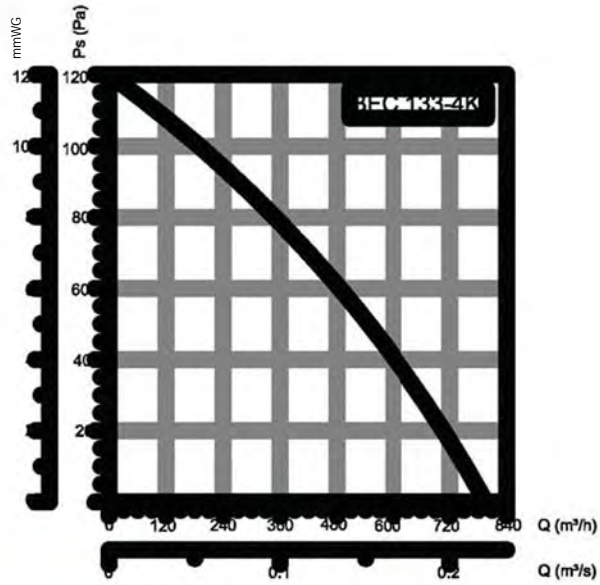

# RADIAL FANS



## QES

AC CENTRIFUGAL BLOWERS

Double Inlet

Double Inlet CES fan have high functional performance used in wide application areas.

### Technical Drawings

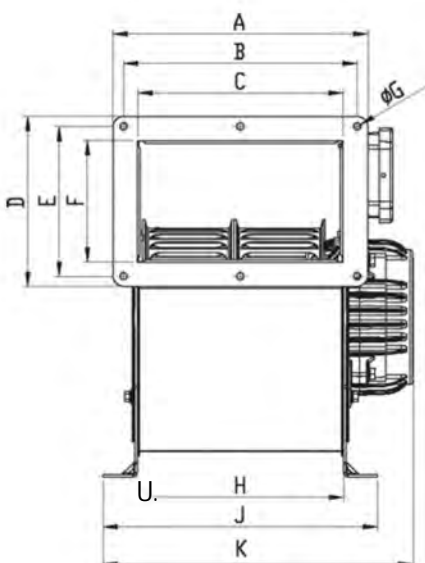
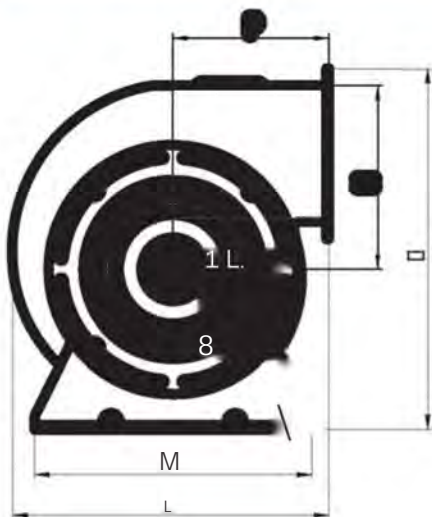

MATERIAL

- Housing is made of electrostatic powder coated sheet metal, forward curved impeller is made of galvanized sheet metal.

INSULATION CLASS

- Class

DIRECTIVE

- EN 60335-1, EN 60335-2-80

SPEED CONTROL

- Speed can be adjusted using an optional controller.

APPLICATION AREAS

- Green houses, factories, depots, dyehouses, shopping centers, workshops(plants) etc. Bigvolumed places to ventilate.

TYPE	V	W	W	(A)	(MF)	d/d	m <sup>3</sup> /h	dB(A)	kg
QES	230	50	217	1,1	8	1420	1300	50	9

TYPE	A	B	C	D	E	F	G	H	J	K	L	M	N	O	P
QES	232	213	187	155	137	111	7	188	250	282	288	252	167	328	142

Dimensions are in (mm)

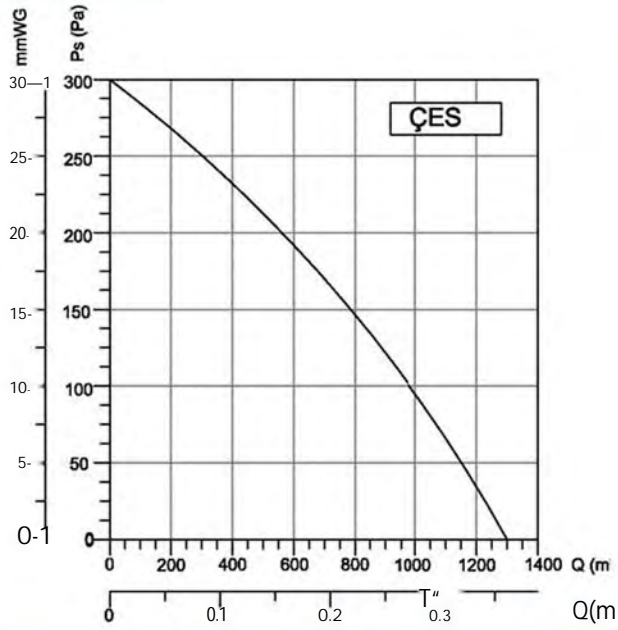

### Accessories



BSC

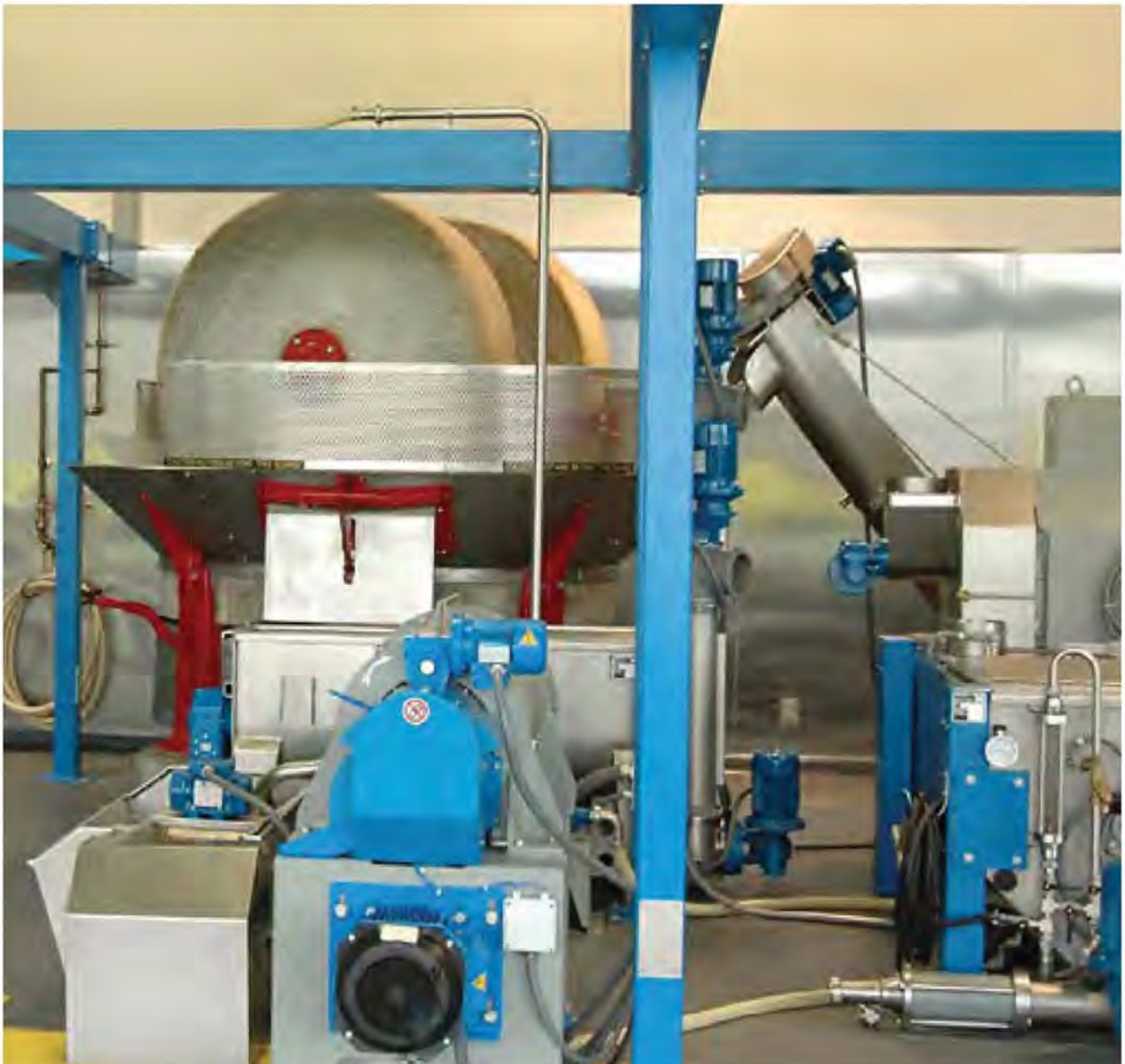

# RADIAL FANS



# OQES

AC CENTRIFUGAL BLOWERS

Double Inlet

OQES fan's compact structure benefits space saving for various cooling and ventilation applications.

## Technical Drawings

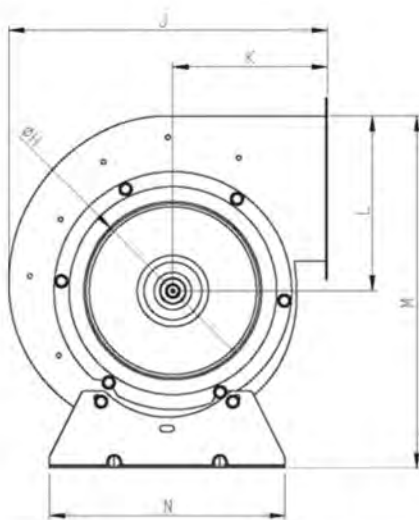
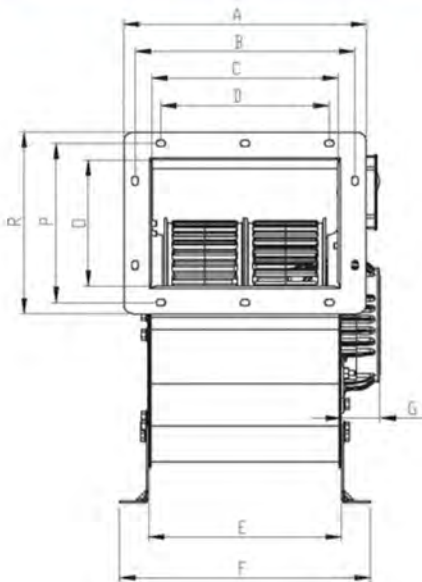

MATERIAL

: Housing is made of electrostatic powder coated sheet metal, forward curved impeller is made of galvanized sheet metal,

INSULATION CLASS

: Class

DIRECTIVE

: EN 60335-1, EN 60335-2-80

SPEED CONTROL

: Speed can be adjusted using an optional controller,

APPLICATION AREAS

: Factories, depots, dyehouses, shopping centers, plastic and packaging machines etc high volumed areas to be vented,

TYPE	VOLTAGE V	FREQUENCY Hz	POWER W	CURRENT (A)	— (MF)	SPEED d/d	AIR FLOW m³/h	SOUND PRESSURE LEVEL dB(A)	— kg
OQES	230	50	400	1,8	10	1250	2200	60	10,3

TYPE	A	B	C	D	E	F	G	H	J	K	L	M	N	O	p	R
OQES	258	234	197	180	210	269	41	190	339	160	±88	396	252	133	169	194

Dimensions are in (mm)

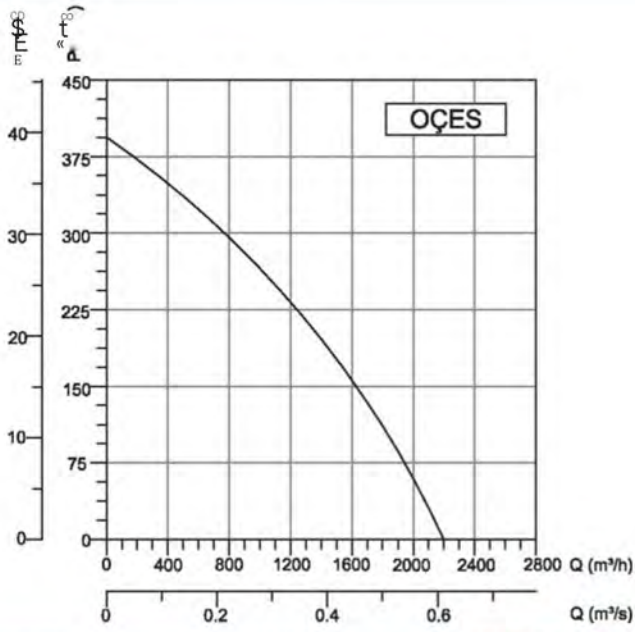

Accessories



BSC



## RADIAL FANS



# BRV/BRV-K

## LOW PRESSURE CENTRIFUGAL BLOWERS Forward Curved

BRV (double inlet fans) can be manufactured for the flow rates between 3500 and 25000 m<sup>3</sup>/h. Max. efficiency with low energy. BRV-K models are reinforced version.

### Technical Drawings

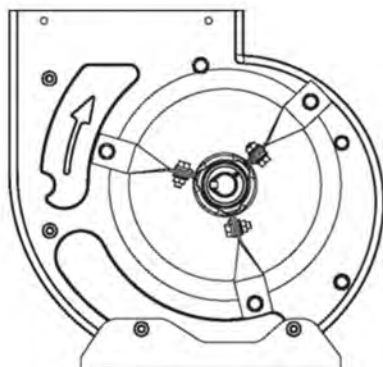
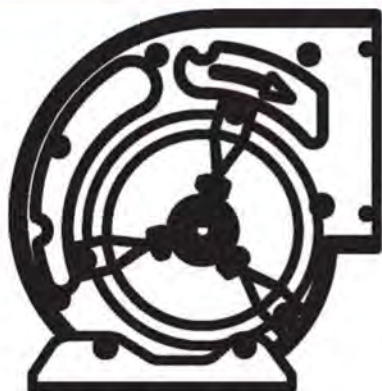

#### MATERIAL

- ⌋ Housing is made of galvanized sheet metal, forward curved fan is made of galvanized sheet metal, shaft is made of ST-45 steel and free axle supported at both ends by permanently greased ball bearings, bearing protectors are made of caoutchouc.

#### DIRECTIVE

- ⌋ EN 60335-1, EN 60335-2-80

#### SPEED CONTROL

- ⌋ Speed is adjusted using belt pulley.

#### APPLICATION AREAS

- ⌋ Ventilation units, central climate units, workplaces, offices, cafes, restaurants, meeting rooms, supermarkets, spor complexes etc. and comfort expected places.

TYPE	$\frac{P}{\rho \cdot \Delta T}$ m <sup>3</sup> /h	$\frac{P}{\rho \cdot \Delta T}$ kg
BRV 7-7	3500	6.1
BRV 9-9	5000	8.2
BRV 10-10	6500	9.4
BRV 12-12	10000	15.5
BRV 15-15	18000	20.7
BRV 18-18	25000	40.5

### Accessories



BDEB



BDH

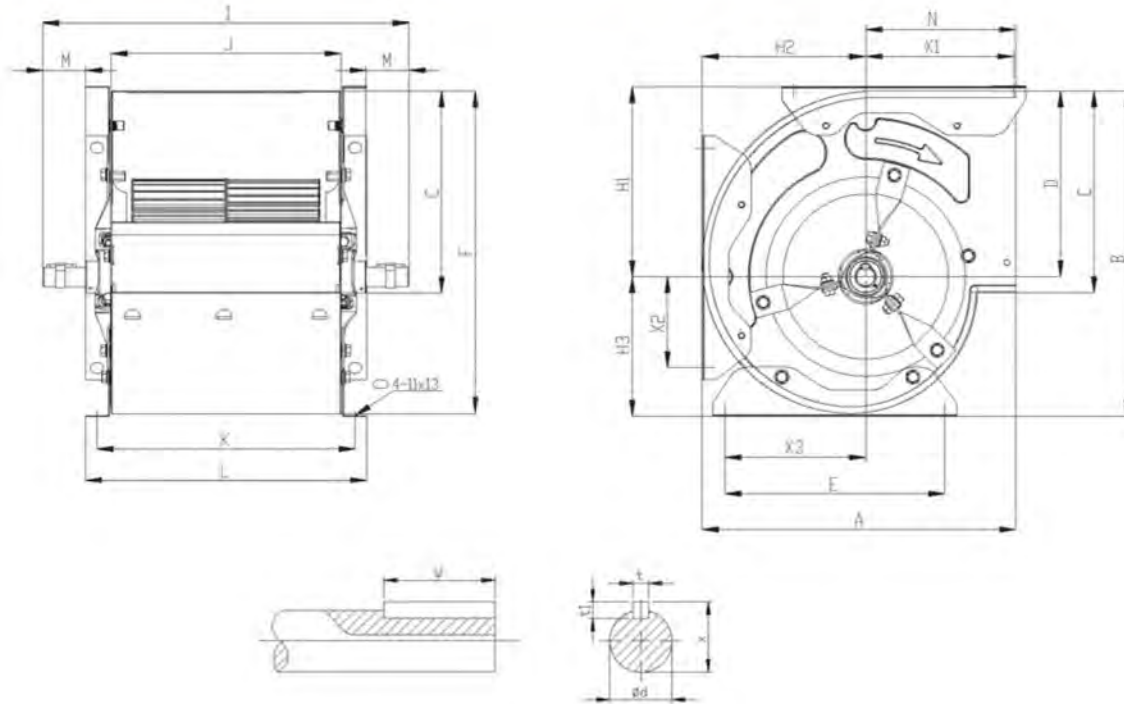

TYPE	A	D	E	F	1	J	L	M	N	X	t	tl	W	d	H1	H2	H3	X1	X2	X3				
BRV7/7 321		333	207	190	225	330	375	236	264.5	287	SW	154	22.56	6	30	20		195	167	142	152	93	144	
BRV9/9 390		400	261	218	300	390	435	296	325.5	350	SW	217	22.56	6	30	20		225	208	182	202	114	184	
BRV 10/10 435		455	290	250	339	445	500	333	361	386	57	197	28	8	7	50	25		258	238	205	161	146	200
BRV12/12 498.5		535	336	292	409	520	580	398	428	453	65	229	28	8	7	50	25		304	270	243	223	139	257
BRV 15/15 597		620	402	341	497	610	650	476	505	531	60	264	28	8	7	60	25		349	324	279	260	214	301
BRV 18/18 687		753	477	411	605.5	732	4	559	591	614	71	313	28	8	7	65	25		424.5	375	342	282	281	330

Dimensions are in (mm)

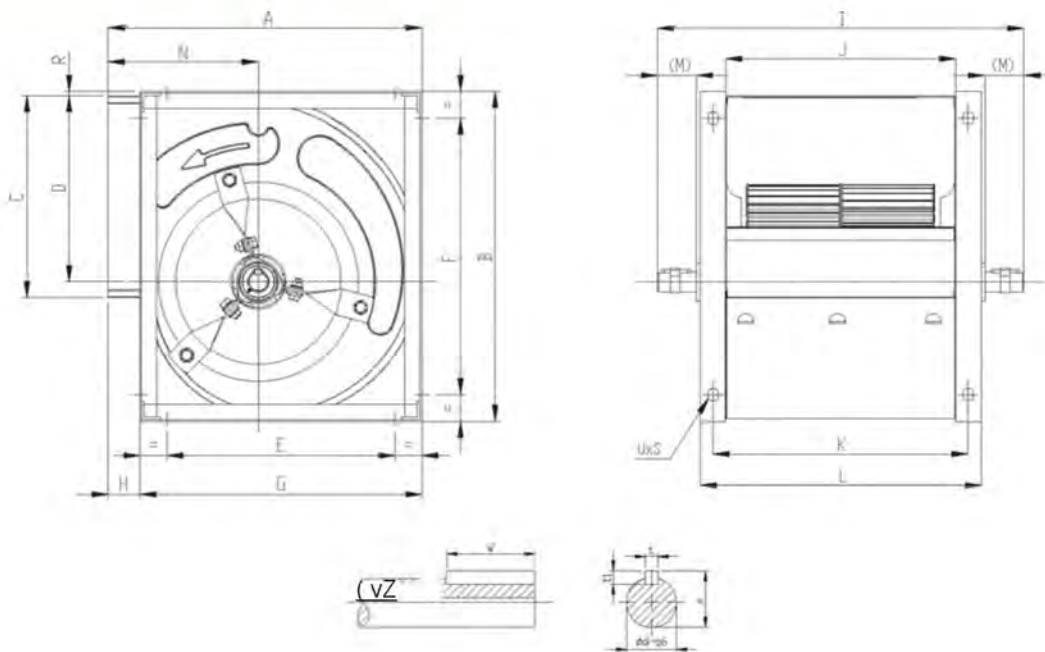

TYPE	Λ	10	D	E	F	G	H	1J	L	M	N	R	t	tl	W	X	d	UxS			
BRV-K 15/15	569	609	404	342	497	531	539	88	675	471	495	75	88	4	8	7	65	33	8	11X16	
BRV-K 18/18	684	739	477	415	608	641	84	88	78	7	88	607	8	314	6	10	8	70	38	8	11X16

Dimensions are in (mm)

# RADIAL FANS

## BRV 7

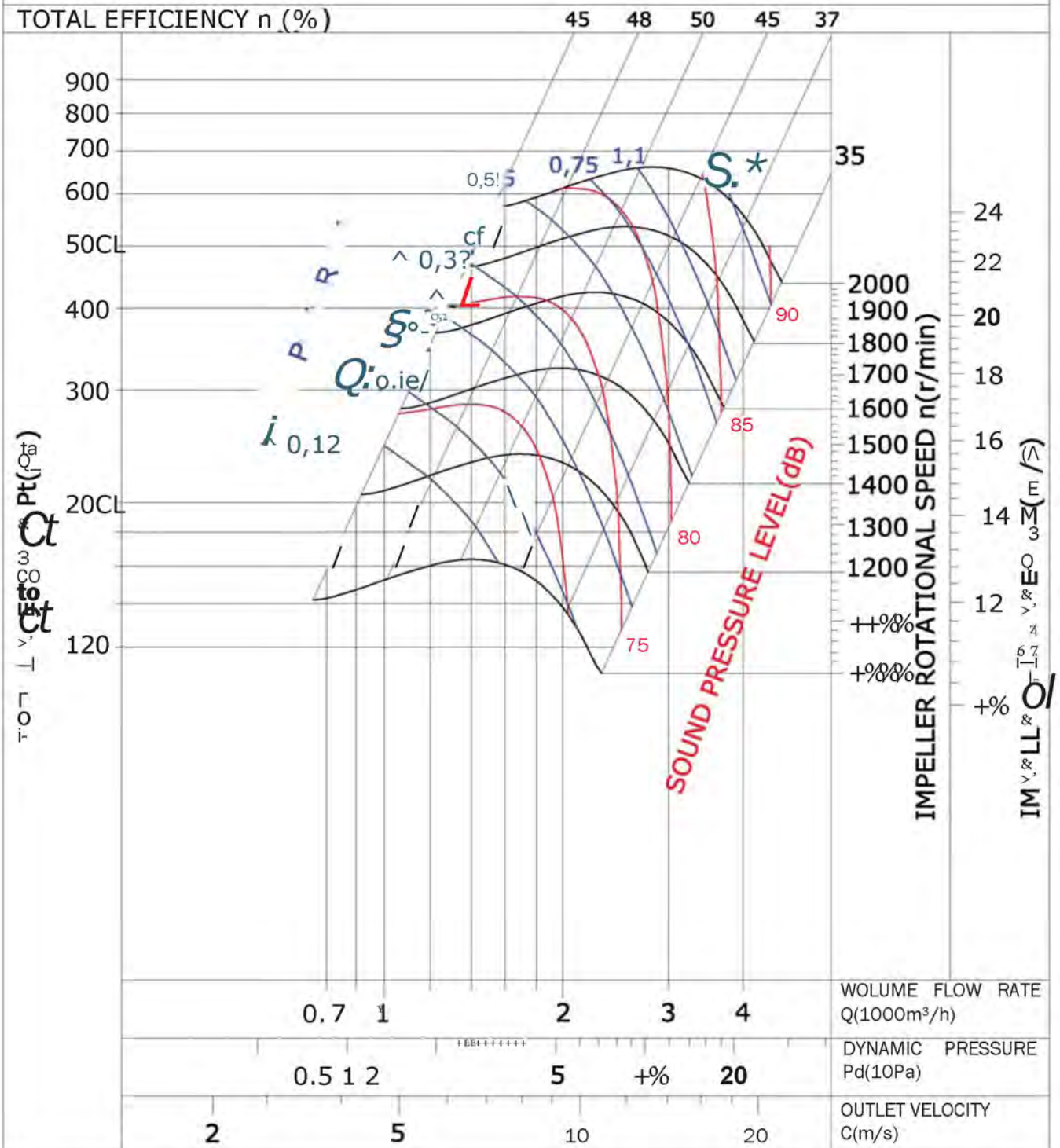





# BRV 9

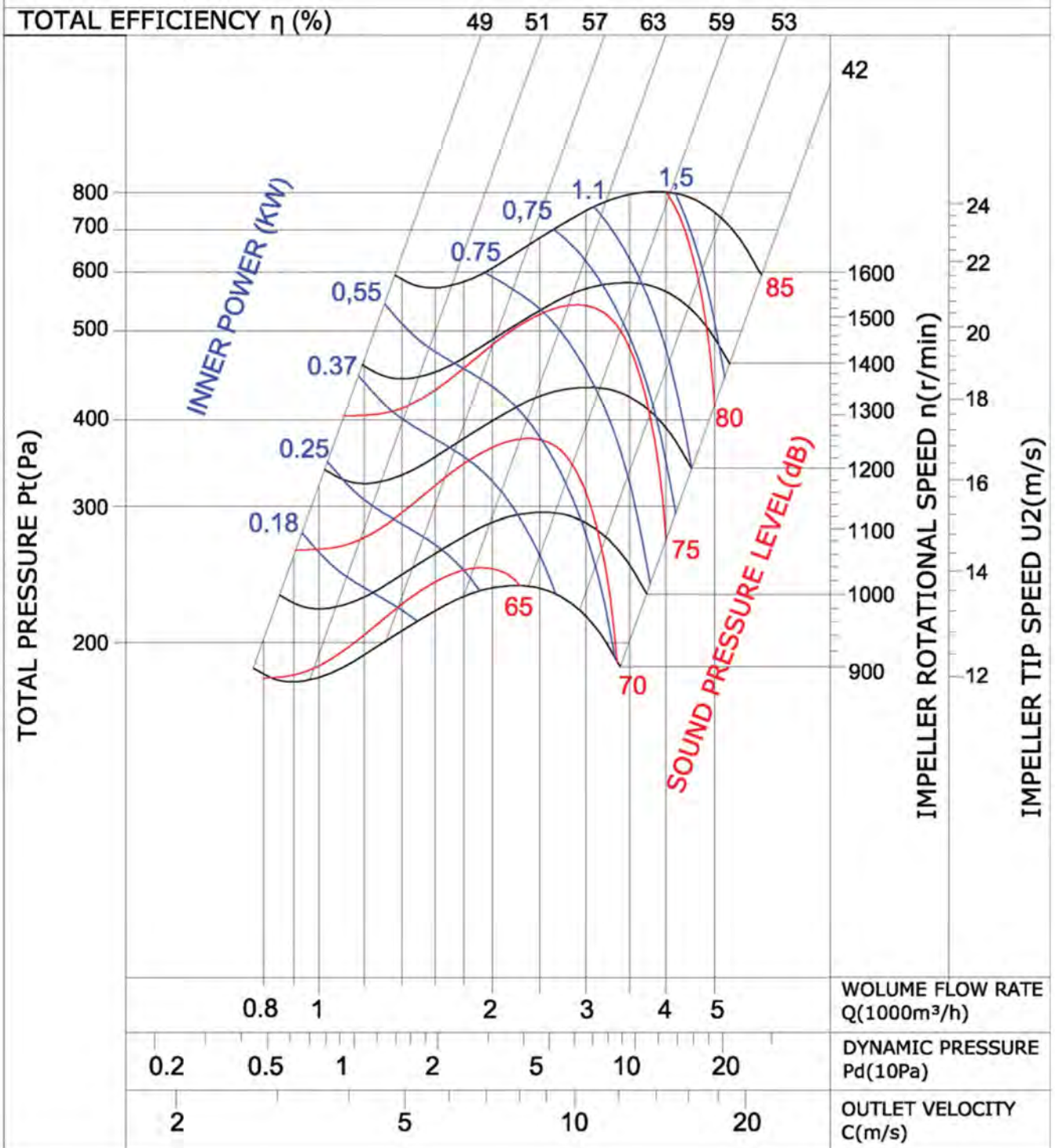

# BRV 10

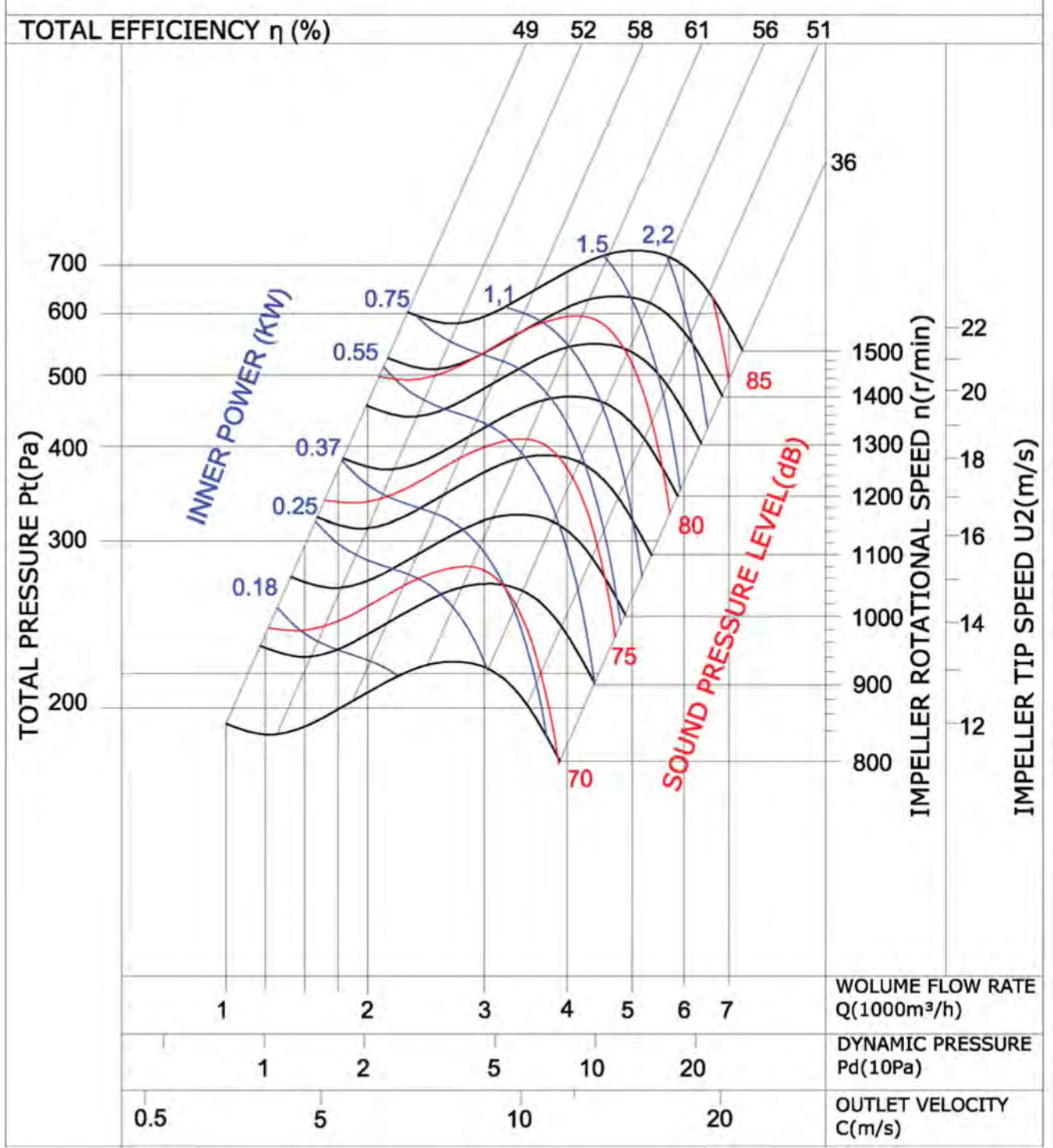



# BRV 12

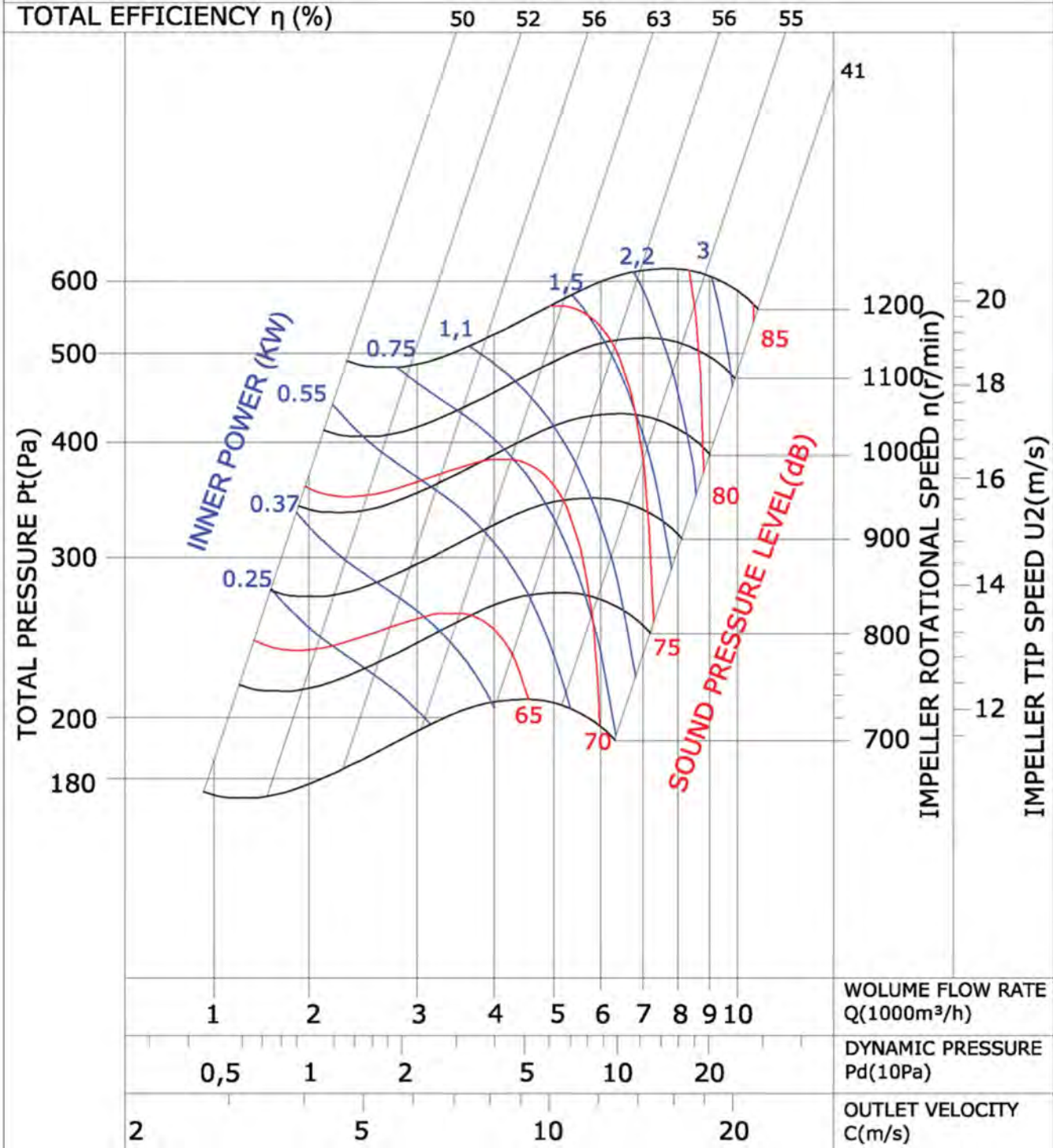

# BRV 15

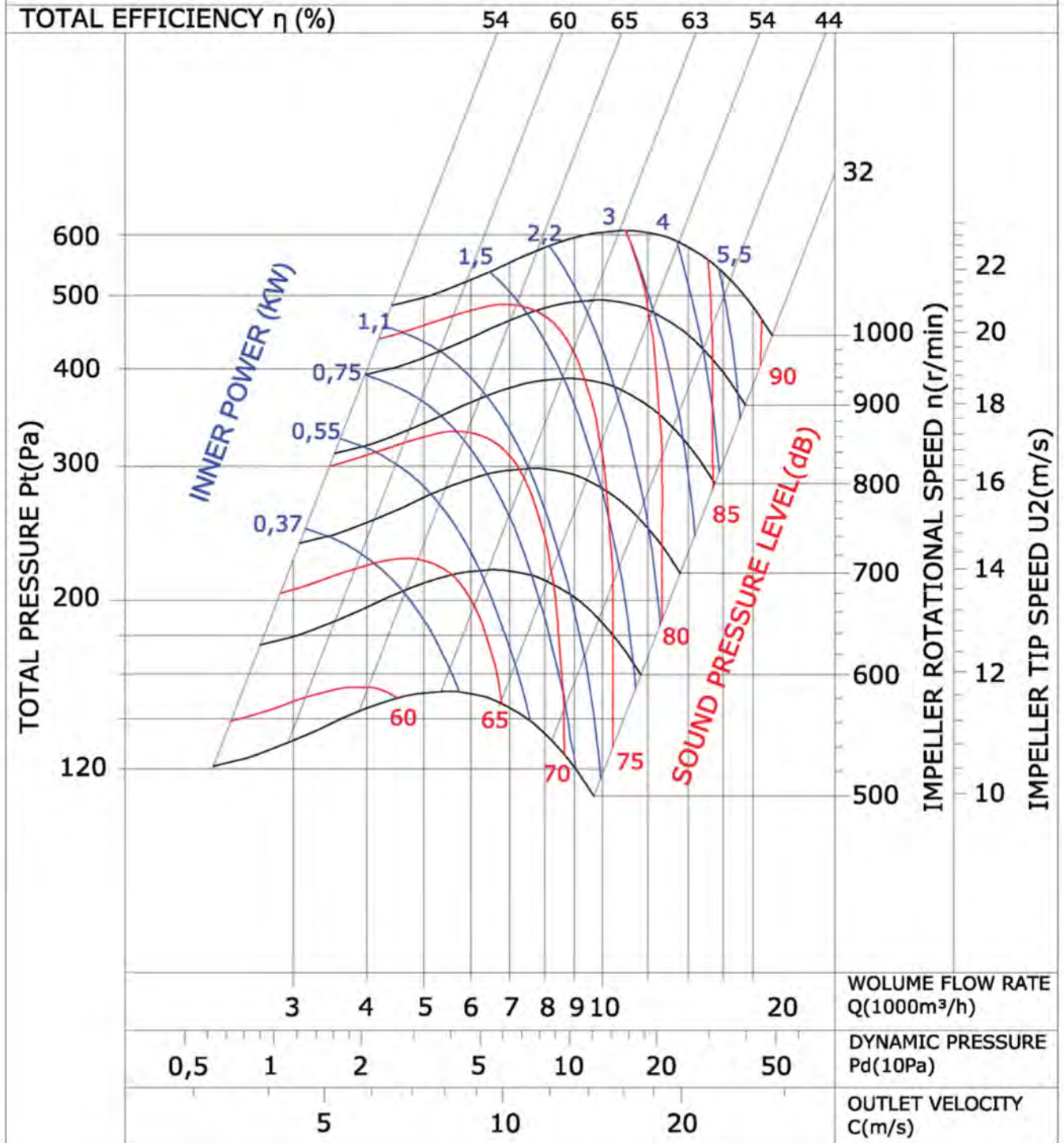



# BRV 18

TOTAL EFFICIENCY  $\eta$  (%)

50 58 64 69 67 58 46

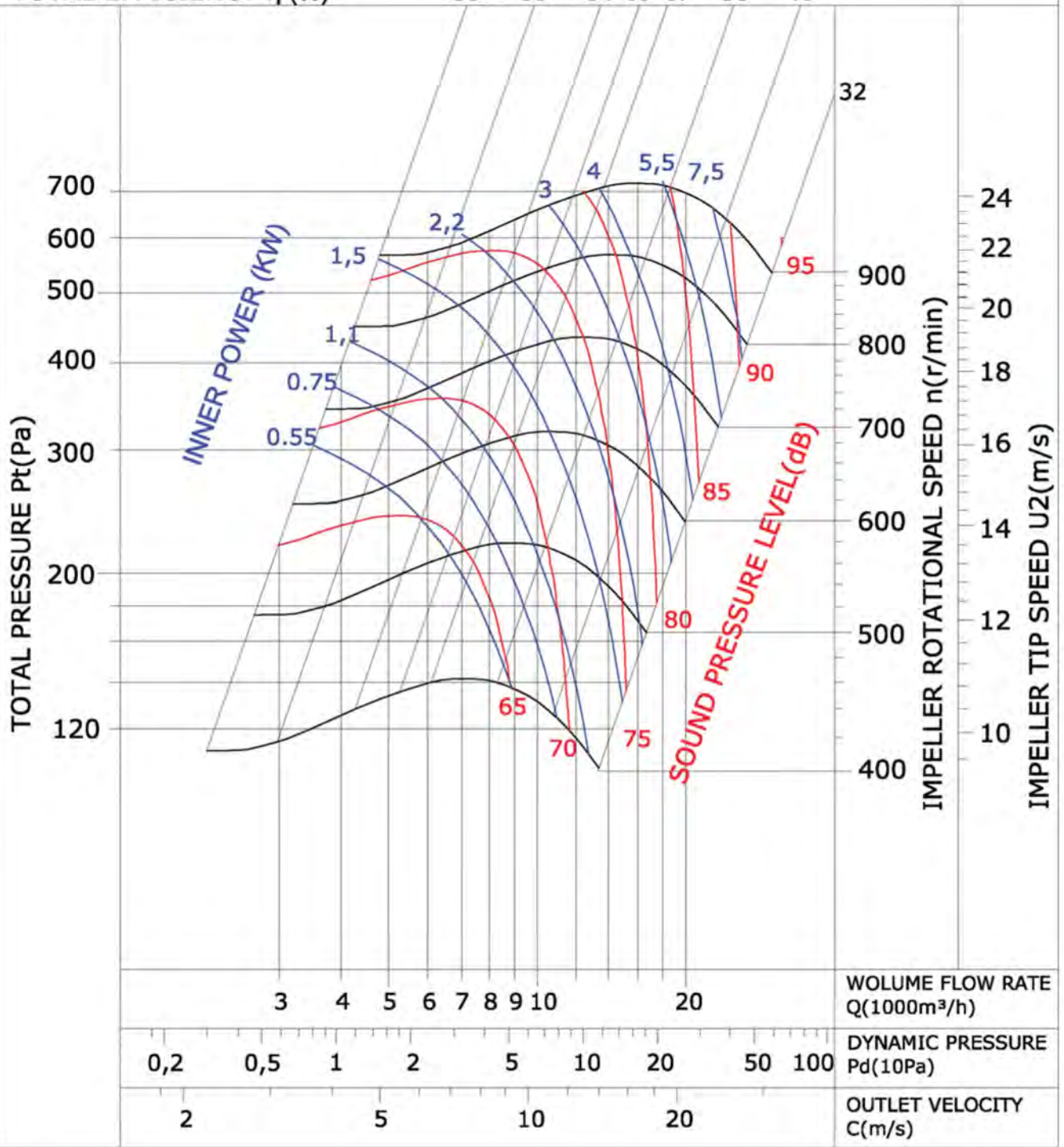

# RADIAL FANS



## BRV-D

### DIRECT DRIVE DOUBLE INLET CENTRIFUGAL FANS

BRV-D Direct drive centrifugal fans supply air volume between 1550 m<sup>3</sup>/h and 6000 m<sup>3</sup>/h with different standard types. The Fan impeller is directly mounted on the motor shaft thus providing efficient motor cooling by the fan air flow.

MATERIAL

: Casing is made of galvanized sheet metal.  
Impeller is made with special designed forward curved galvanized sheet metal.

INSULATION CLASS

: Class

DIRECTIVE

: EN 60335-1, EN 60335-2-80

SPEED CONTROL

: Speed can be adjusted using an optional controller.

APPLICATION AREAS

: Air Handling Units, Ventilation Units, Heat Recovery Units

## Technical Drawings

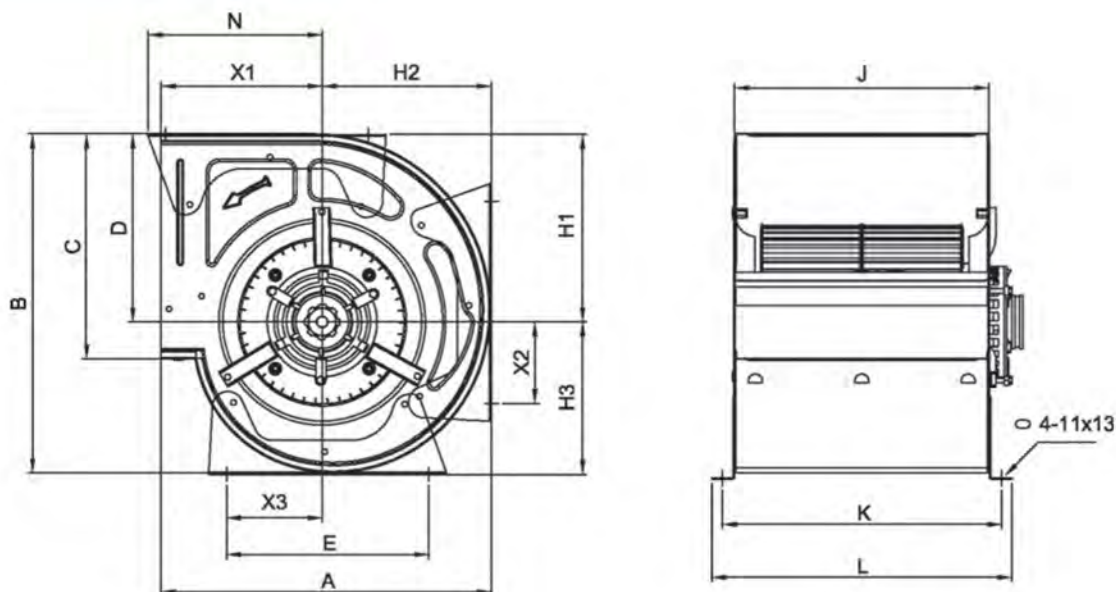

TYPE	A	D	E	J	L	N	H1	H2	H3	X1	X2	X3						
BRV D 7-7	321	333	207	190	225	236	264,5	287,5	154	195	167	142	152	93	144			
BRV D 9-9	390	400	261	218	300	296	325,5	350,5	217	225	208	182	202	114	184			
BRV D 10-10	435	455	290	250	339	333	361	386	197	258	238	205	161	146	200			
BRV D 12-12	498,5	535	336	292	409	398	428	453	229	304	270	243	223	139	257			

Dimensions are in (mm)

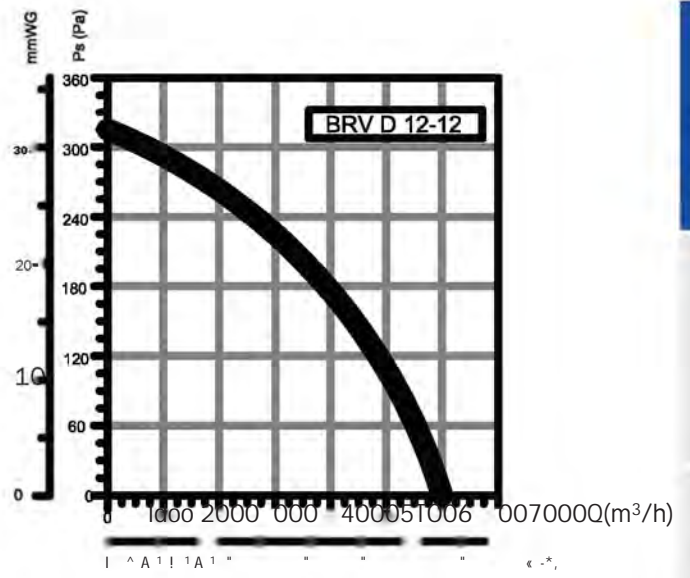
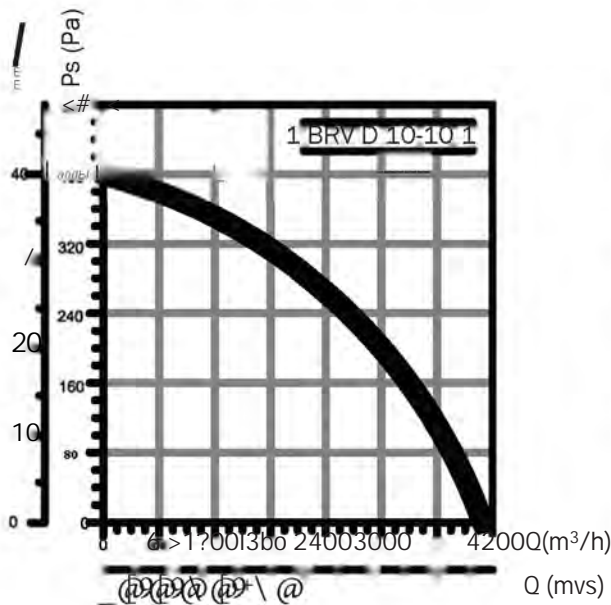
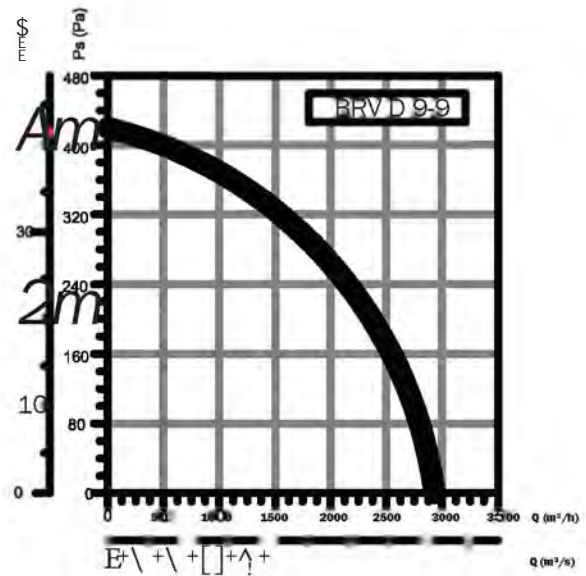
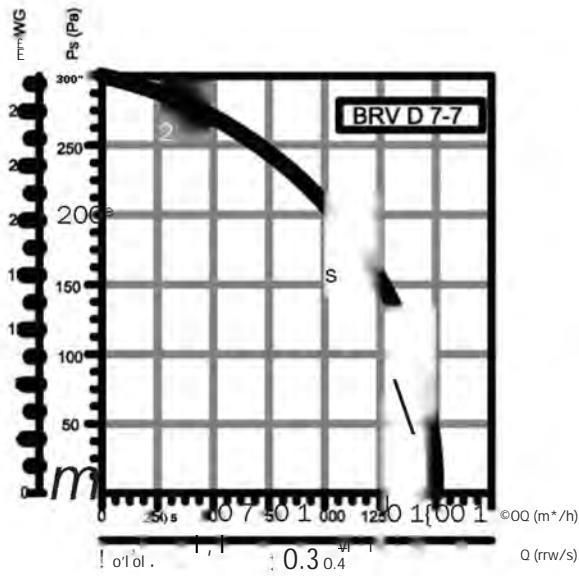

TYPE	VOLTAGE V	FREQUENCY Hz	POWER W	CURRENT (A)	CAPACITOR (MF)	SPEED d/d	FLOW RATE m³/h	SOUND PRESSURE LEVEL dB(A)	WEIGHT kg
BRV D 7-7	230	50	147	1,7	7	1300	1550	71	9
BRV D 9-9	230	50	373	5,1	12	1380	2900	78	13
BRV D 10-10	230	50	600	3,3	18	1380	4100	80	15
BRV D 12-12	380	50	1100	5,8	-	900	6000	80	26

# RADIAL FANS



# BRV-S

LOW PRESSURE CENTRIFUGAL FANS

Single Inlet

BRV-S (single inlet fans) can be manufactured for the flow rates between 1000 and 20000 m<sup>3</sup>/h. Max. efficiency with low energy.

## Technical Drawings



MATERIAL

: Housing is made of galvanized sheet metal, forward curved fan is made of galvanized sheet metal, shaft is made of ST-45 steel and free axle supported at both ends by permanently greased ball bearings

DIRECTIVE

: EN 60335-1, EN 60335-2-80

SPEED CONTROL

: Speed can be adjusted using an optional controller.

APPLICATION AREAS

: Ventilation units, central climate units, workplaces, offices, cafes, restaurants, meeting rooms, supermarkets, sport complexes etc. and comfort expected places.

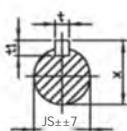
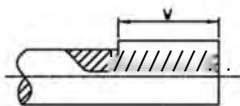
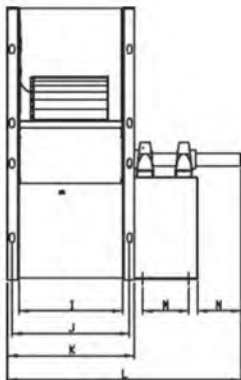

TYPE	AIR FLOW m <sup>3</sup> /h	WEIGHT kg
BRV-S 10-5	5000	9
BRV-S 12-6	10000	13
BRV-S 15-8	14000	17
BRV-S 18-10	20000	38

## Accessories



BDEB

TYPE	A	B	D	E	F	G	H	I	J	L	M	N	O	P	Q	R	S	T	U	V	W	X	Y	Z
BRV-S 10-5	427	450	290	250	197	280	35	393	180	213	236	415	60	74	8	8	25	65	12x18					
BRV-S 12-6	488	511	350	310	257	340	35	453	215	250	272	487	76	83	8	8	25	65	12x18					
BRV-S 15-8	548	571	410	370	317	400	35	538	260	293	316	576	150	96	10	8	35	70	12x18					
BRV-S 18-10	608	631	470	430	377	460	35	643	300	338	360	676	150	117	10	8	35	70	12x18					

Dimensions are in (mm)



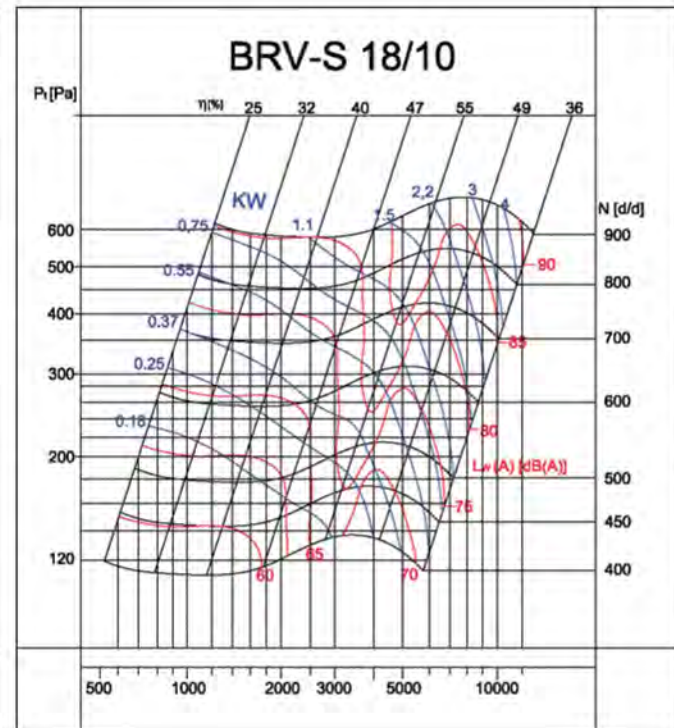
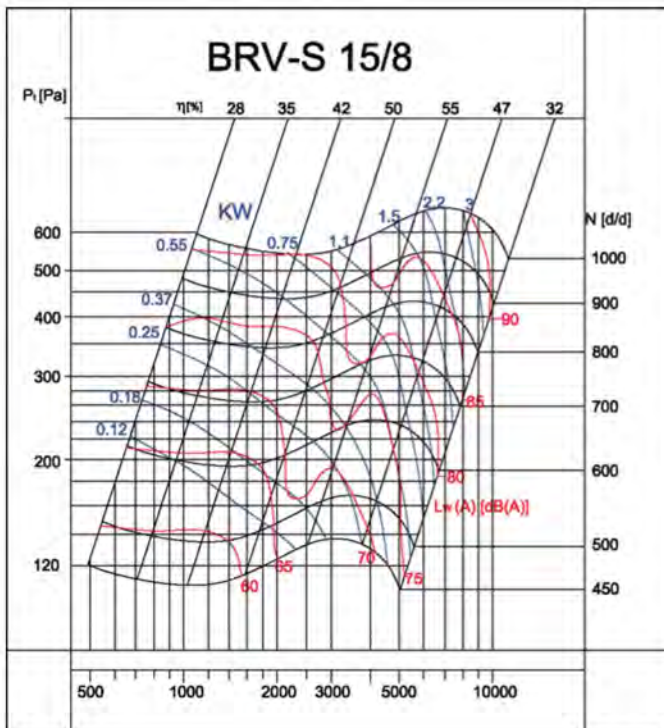
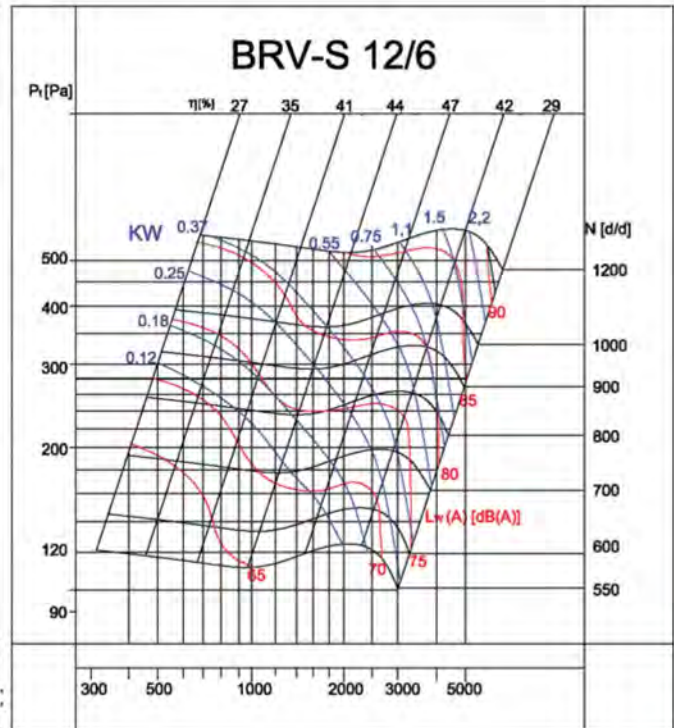
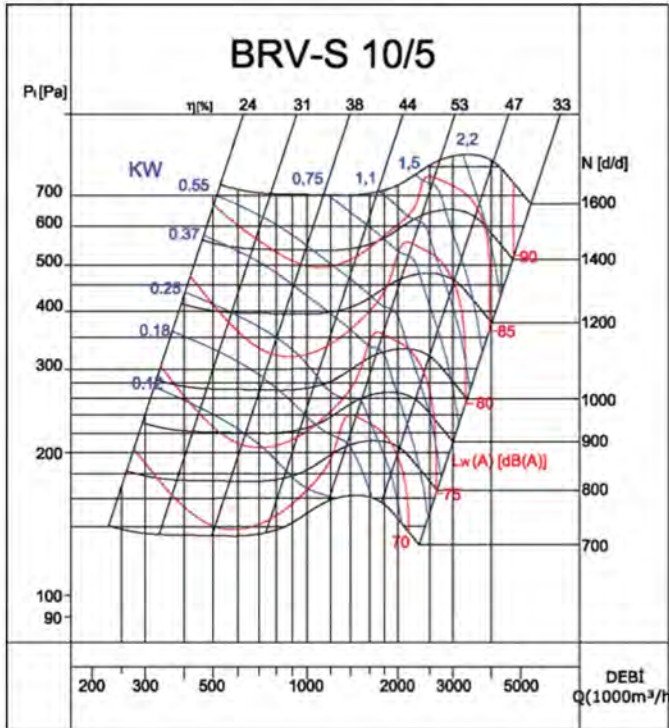

# RADIAL FANS

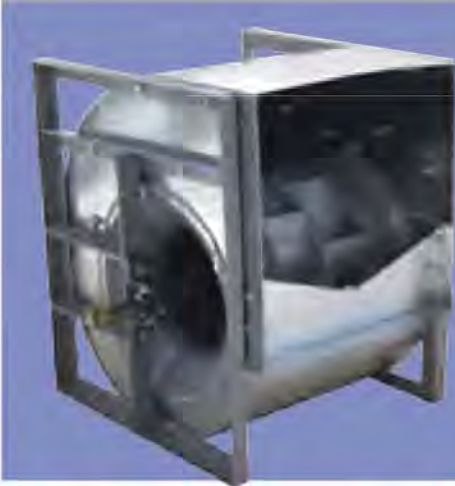

# BSK

HIGH PRESSURE CENTRIFUGAL FANS

Backward Curved - Welded

BSK (double inlet fans) can be manufactured for the flow rates between 500 and 32000 m<sup>3</sup>/h. Max. efficiency with low energy.

## Technical Drawings

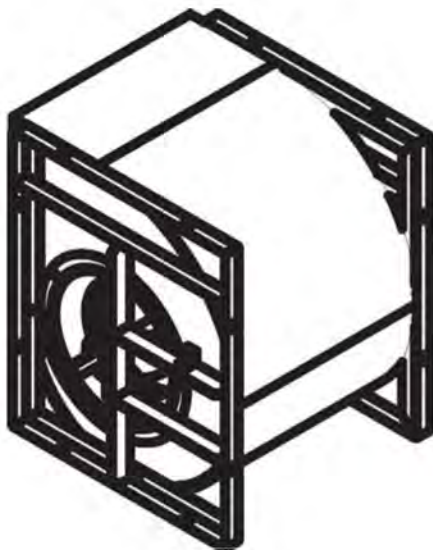
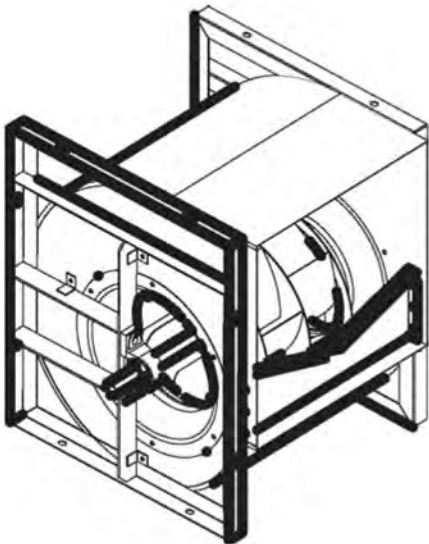

- MATERIAL** : Housing is made of galvanized sheet metal, forward curved fan is made of galvanized sheet metal, shaft is made of ST-45 steel and free axle supported at both ends by permanently greased ball bearings.
- DIRECTIVE** : EN 60335-1, EN 60335-2-80
- SPEED CONTROL** : Speed is adjusted using belt pulley.
- APPLICATION AREAS** : Ventilation units, central climate units, workplaces, offices, cafes, restaurants, meeting rooms, supermarkets, spor complexes etc. and comfort expected places.

TYPE	Q <sub>v</sub> m <sup>3</sup> /h	W <sub>e</sub> kg
BSK 250	3000	18
BSK 280	6000	22
BSK 315	8000	33
BSK 355	10000	45
BSK 400	15000	52
BSK 450	18000	68
BSK 500	26000	85
BSK 560	32000	140

## Accessories



BDAB

BDH

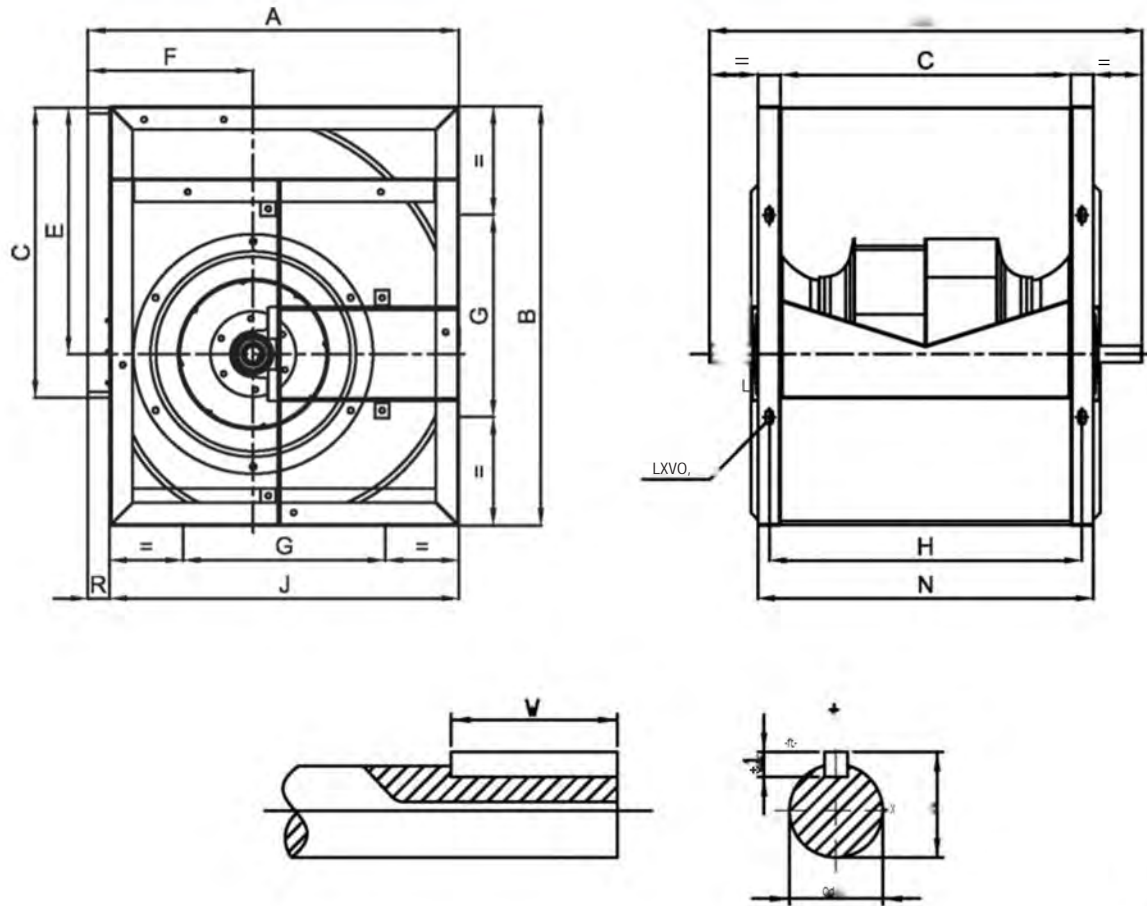

TYPE	A		E	F	G	J	M	N	R	t	II	W	X	Uxv	
BSK 250	419	461	322	195	280	384	30	536	372	8	7	50	28	25	13X18
BSK 280	488	518	361	215	280	432	30	575	421	8	7	50	28	25	13X18
BSK 315	518	578	404	240	280	480	30	640	464	8	7	60	28	25	13x18
BSK 355	588	655	453	261	280	548	40	700	520	8	7	60	33	30	13x18
BSK 400	651	736	507	290	280	613	40	760	589	8	7	60	33	30	13x18
BSK450	727	827	569	320	280	681	40	845	651	10	8	70	38	35	13x18
BSK 500	808	918	638	352	280	750	40	920	718	12	8	70	43	40	13x18
BSK 560	888	1031	715	390	280	845	50	1070	815	14	9	90	53,5	50	13x18
BSK 630	999	1157	815	434	280	946	50	1155	901	14	9	90	53,5	50	13x18

Dimensions are in (mm)



# RADIAL FANS

## BSK 250

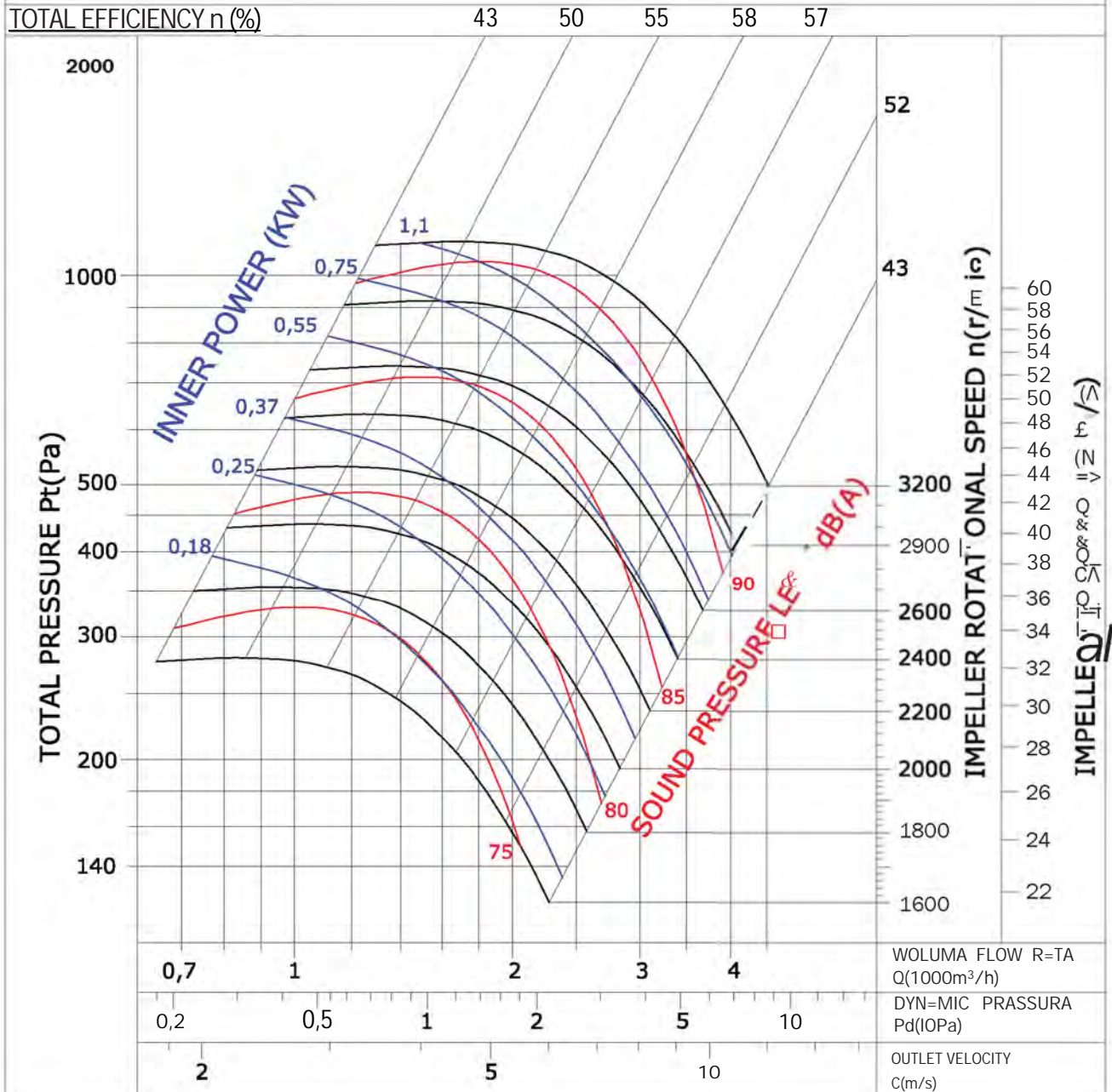



# BSK 280

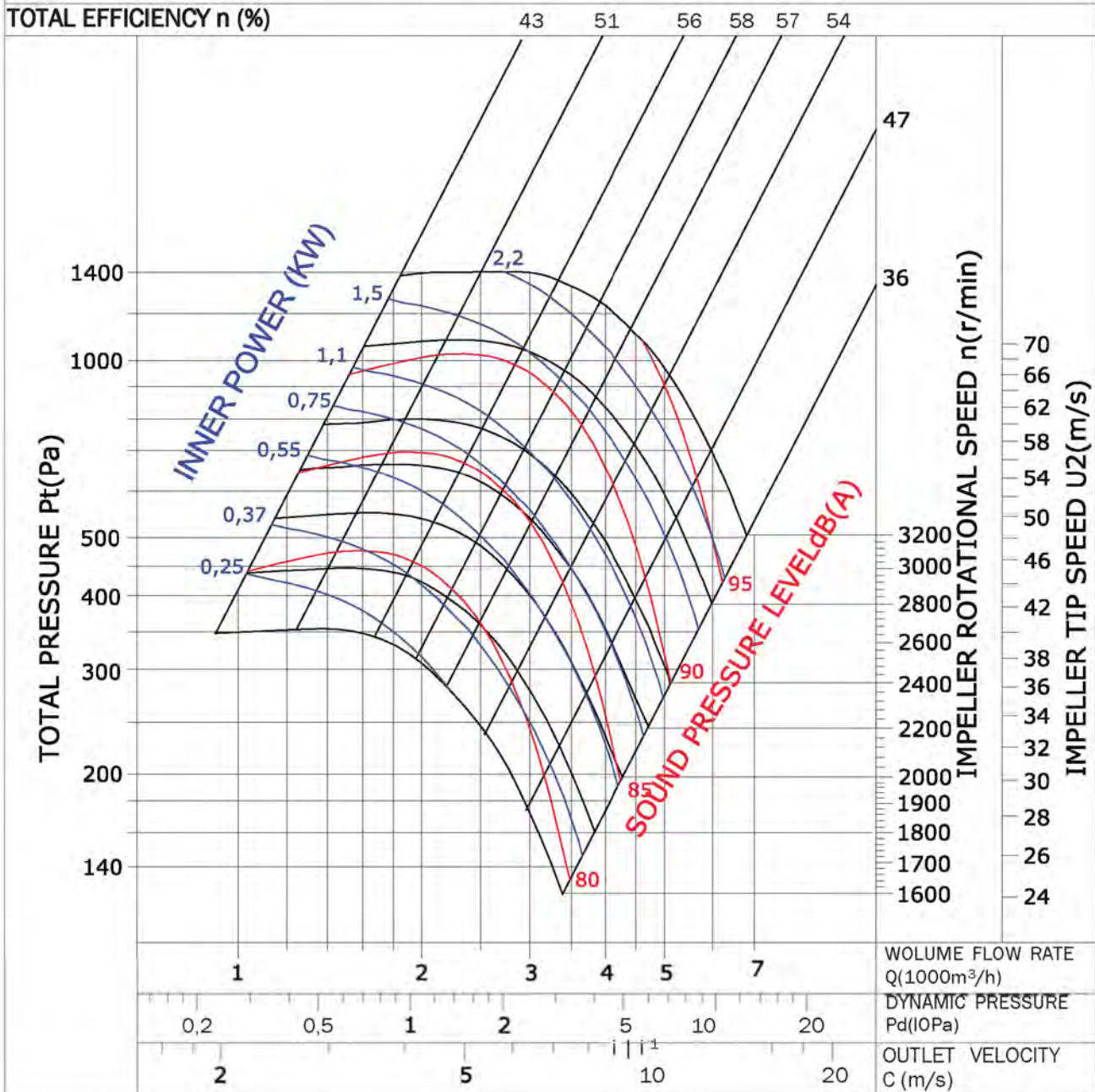

DUCT FANS

ROOF FANS

AXIAL FANS

RADIAL FANS

PLASTIC FANS

VENTILATORS

SMOKE EXHAUST SYSTEMS

...

...

# BSK 315

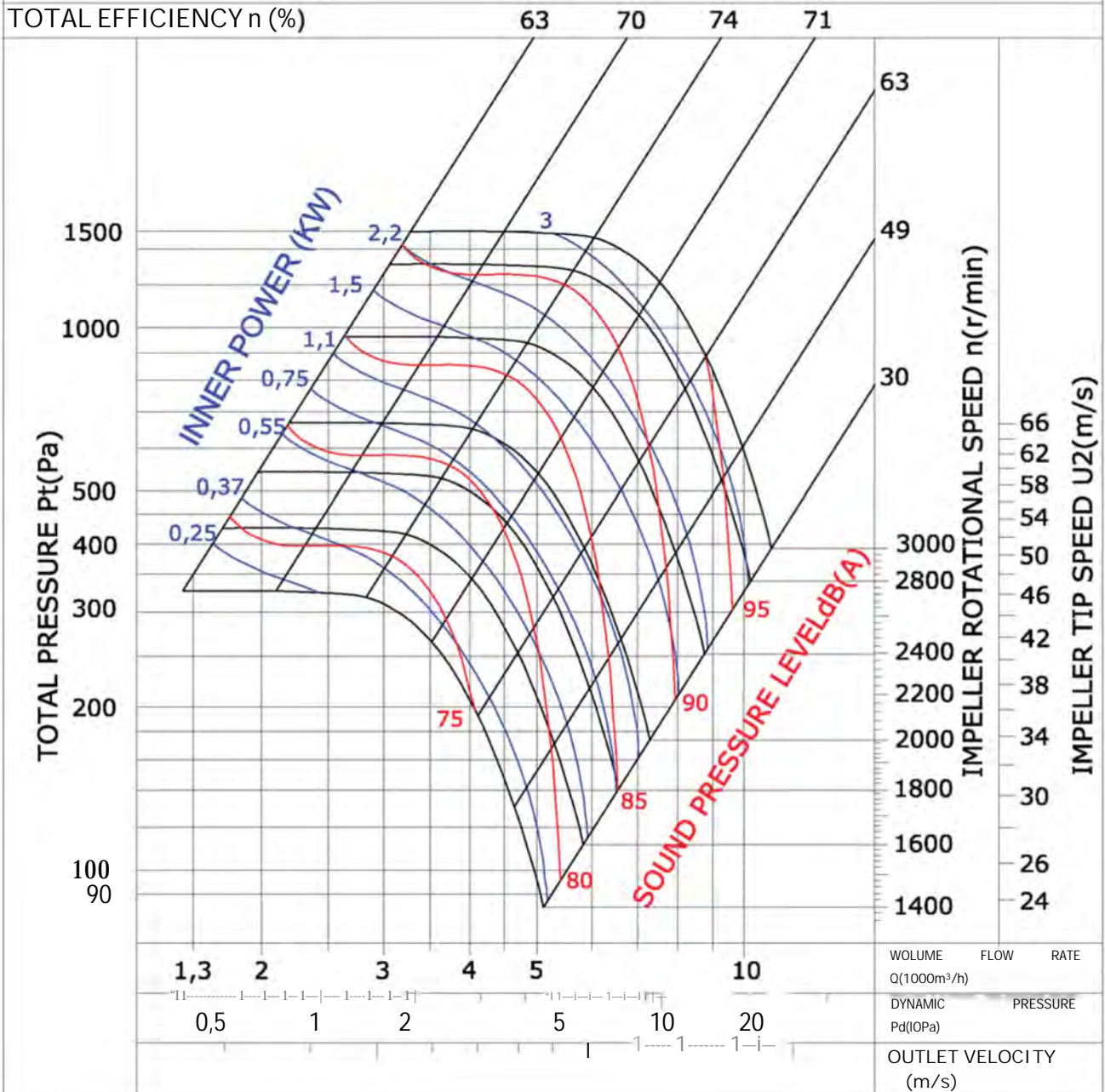



# BSK 355

TOTAL EFFICIENCY  $\eta$  (%)

63 70 74 71

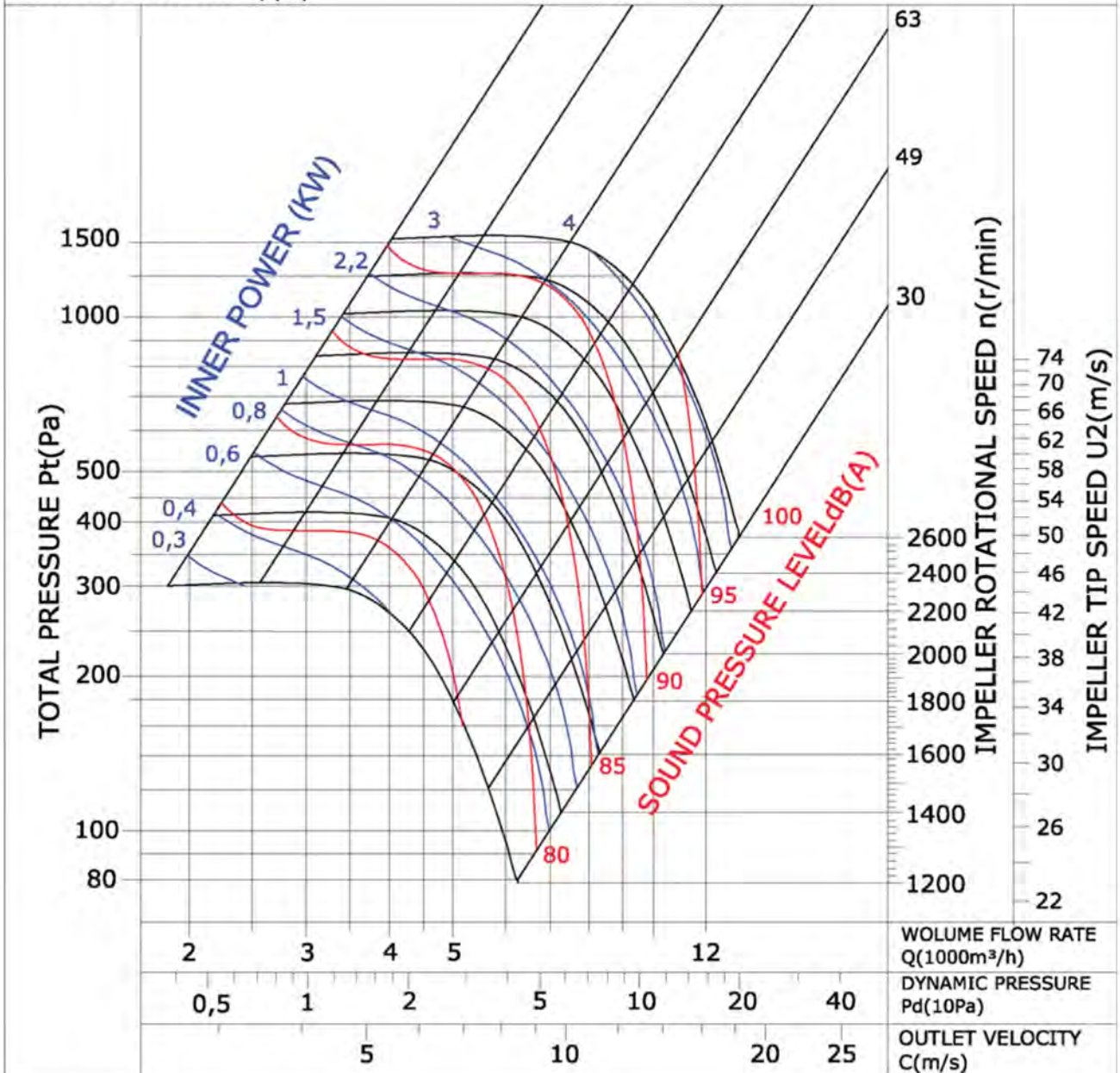

# BSK 400

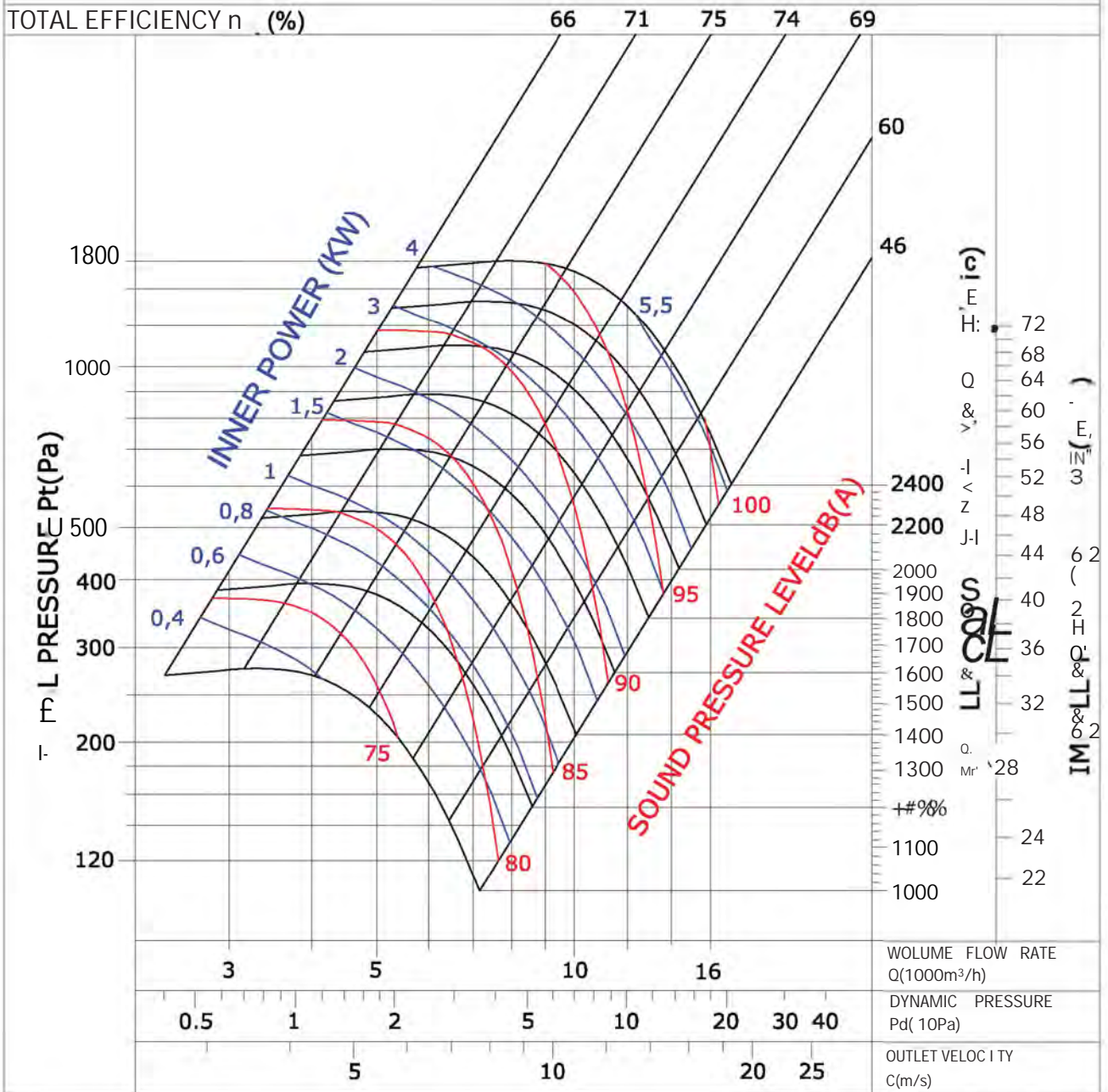





# BSK 450

TOTAL EFFICIENCY  $\eta$  (%)

66 71 75 74 69

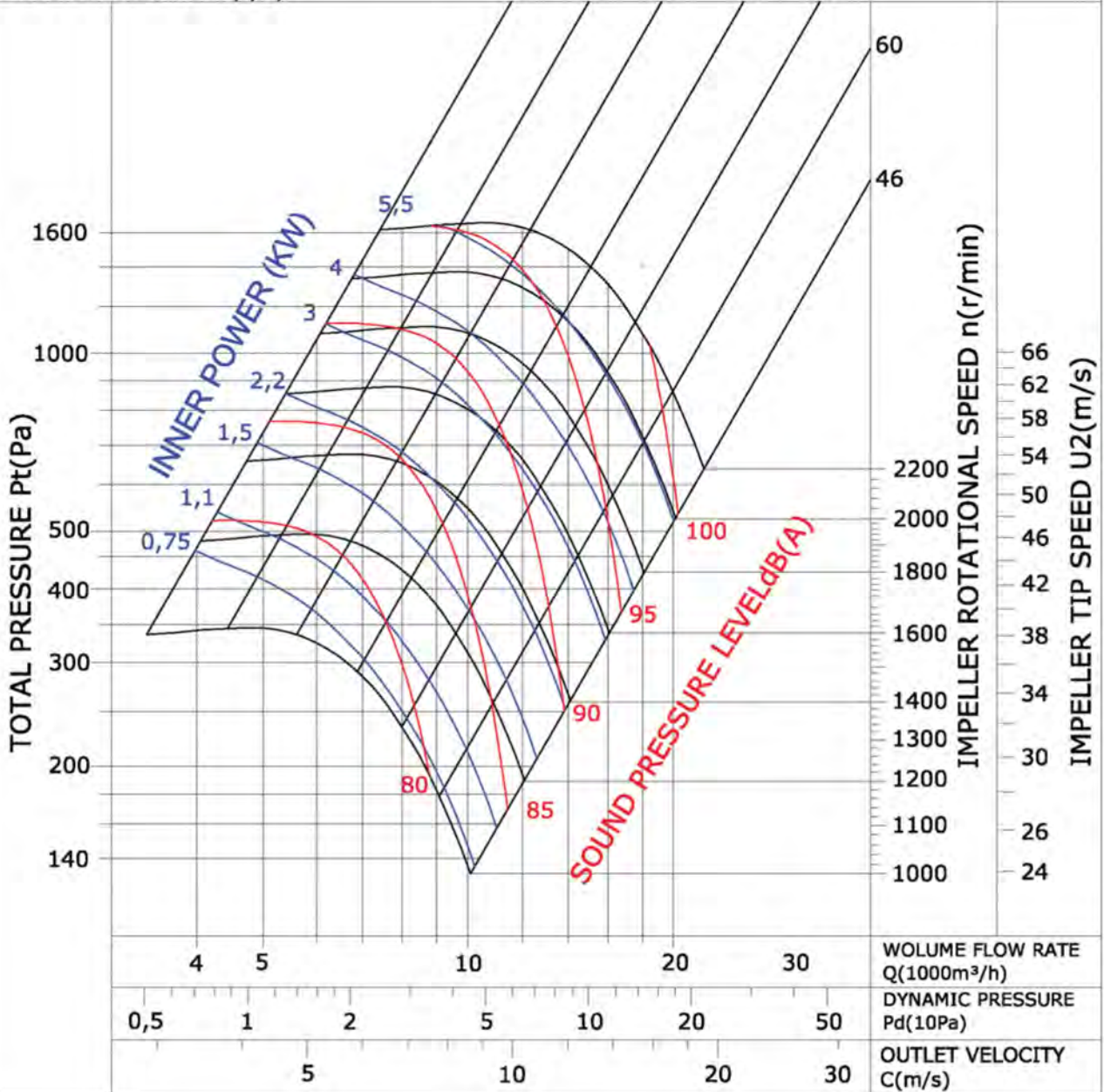

# BSK 500

TOTAL EFFICIENCY  $\eta$  (%)

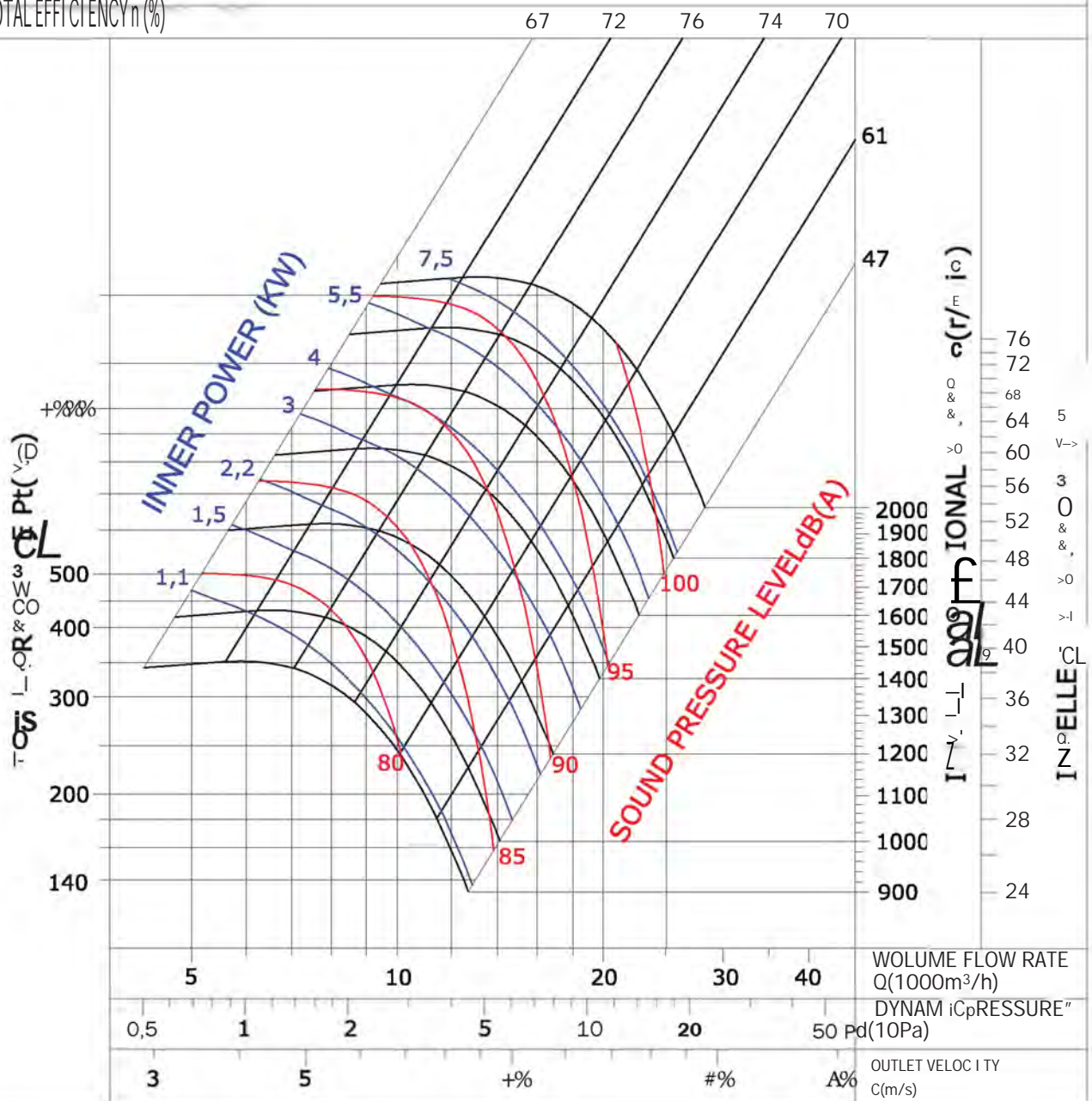



# BSK 560

TOTAL EFFICIENCY  $\eta$  (%)

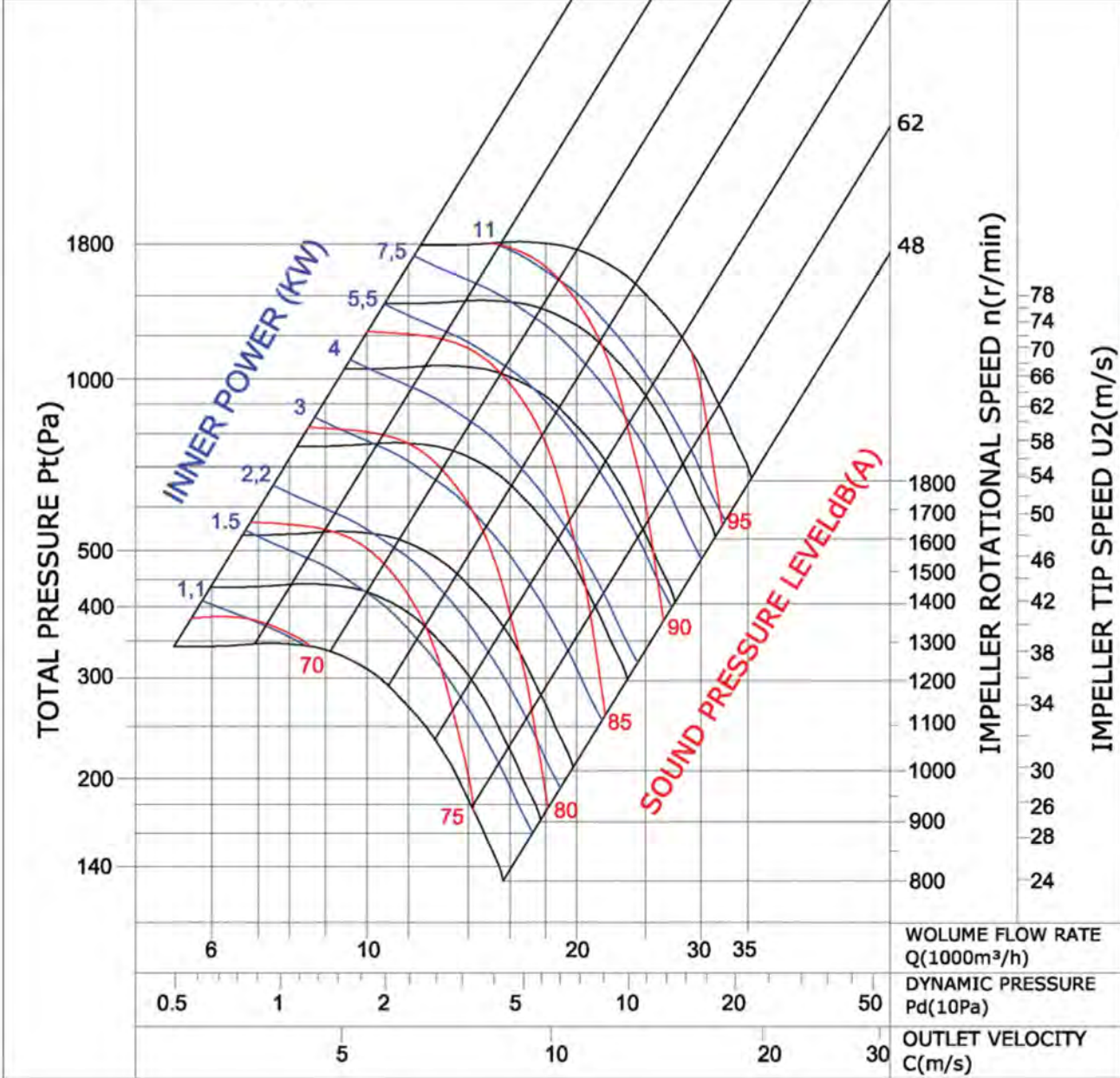

# RADIAL FANS

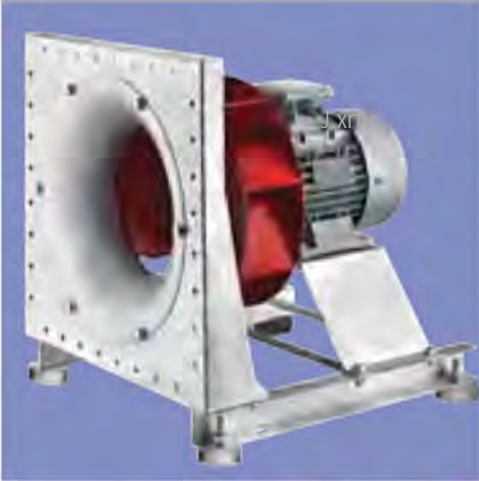

## BPF

PLUG FAN

Backward Curved

Compact module. Optimized aerodynamically and acoustically executions. Static pressure increase up to 2,000 Pa in the optimum range. Impeller diameter is 250 up to 560 mm nominal size. Motor with three PTC resistors, suitable for operation at frequency.

### Technical Drawings

- MATERIAL** : Housing is made of galvanized sheet metal, fan is manufactured electrostatic powder painted and welded.
- INSULATION CLASS** : Class F
- DIRECTIVE** : EN 60335-1, EN 60335-2-80
- SPEED CONTROL** : Speed can be adjusted using an optional controller.
- APPLICATION AREAS** : In industrial air conditioning applications they save from energy and space. Plug fans are preferred in hygienic air handling units because they are easily cleaned and maintained.

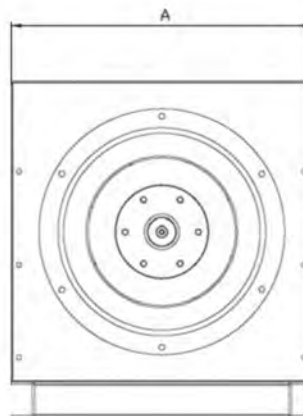
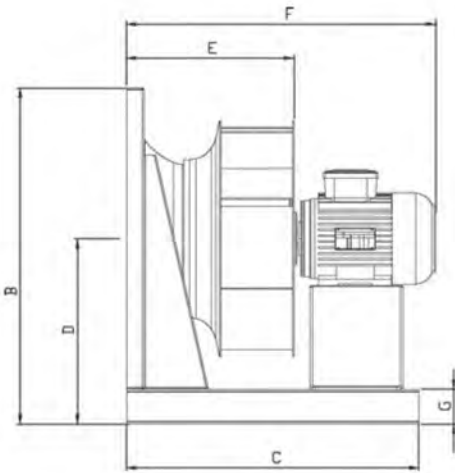

TYPE	A			D	E	F	G
BPF 250 A	375	425	400	237,5	185	370	50
BPF 250	375	425	400	237,5	185	400	50
BPF 280 A	390	440	420	245	210	410	50
BPF 280	390	440	450	245	210	435	50
BPF315 A	430	490	480	275	235	460	60
BPF315	430	490	480	275	235	480	60
BPF 355 A	470	530	500	295	260	485	60
BPF 355	470	530	500	295	260	525	60
BPF 400 A	515	575	500	317,5	285	530	60
BPF 400	515	575	600	317,5	285	650	60
BPF 450 A	582	642	600	351	315	580	60
BPF 500 A	645	705	650	382,5	350	640	60
BPF 560 A	715	775	700	417,5	385	705	60

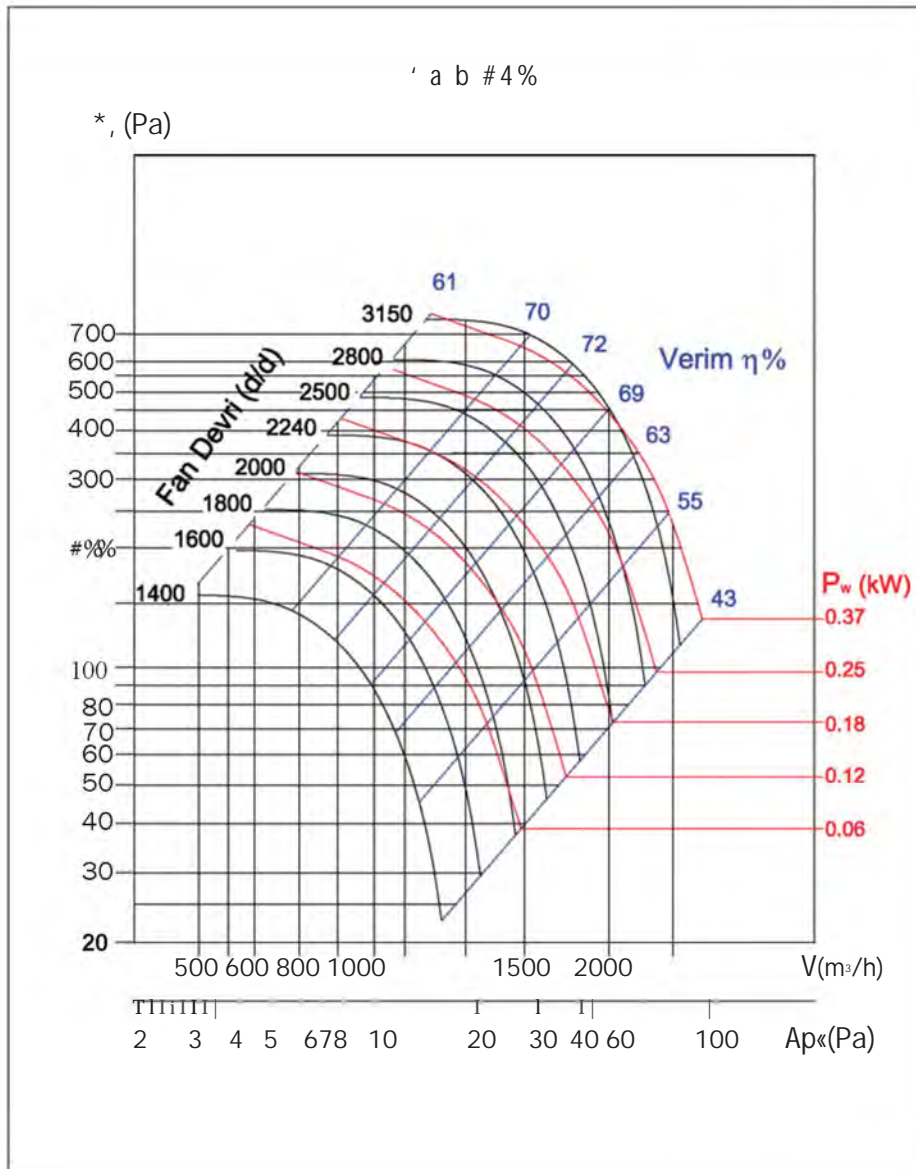

TYPE	V	Hz	w	(A)	d/d	K <sub>g</sub>	dB(A)	kg
BPF 250 A 230/380		50	63	0,18	1400	800	120	17
BPF 250	230/380	50	71	0,37	2800	1500	500	19
BPF 280 A 230/380		50	63	0,18	1400	1100	170	21
BPF280	230/380	50	71	0,55	2800	2200	600	23
BPF 315 A 230/380		50	71	0,37	1400	1600	200	24
BPF315	230/380	50	80	1	2800	3200	750	26
BPF 355 A 230/380		50	71	0,37	1400	2500	250	28
BPF355	230/380	50	90S	1,5	2800	4250	850	35
BPF 400 A 230/380		50	80	0,55	1400	3250	300	31
BPF 400	380	50	112 M	4	2800	6500	1200	48
BPF 450 A 230/380		50	80	0,75	1400	4300	370	40
BPF500 A	230/380	50	90L	1,5	1400	6500	450	54
BPF 560 A 230/380		50	100L	2,2	1400	9000	600	70

# RADIAL FANS

## BPF 280

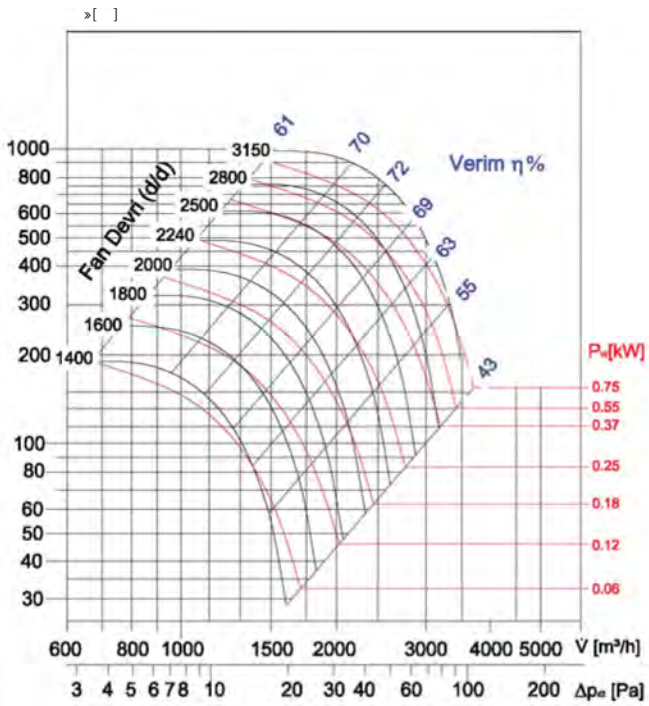

## BPF315

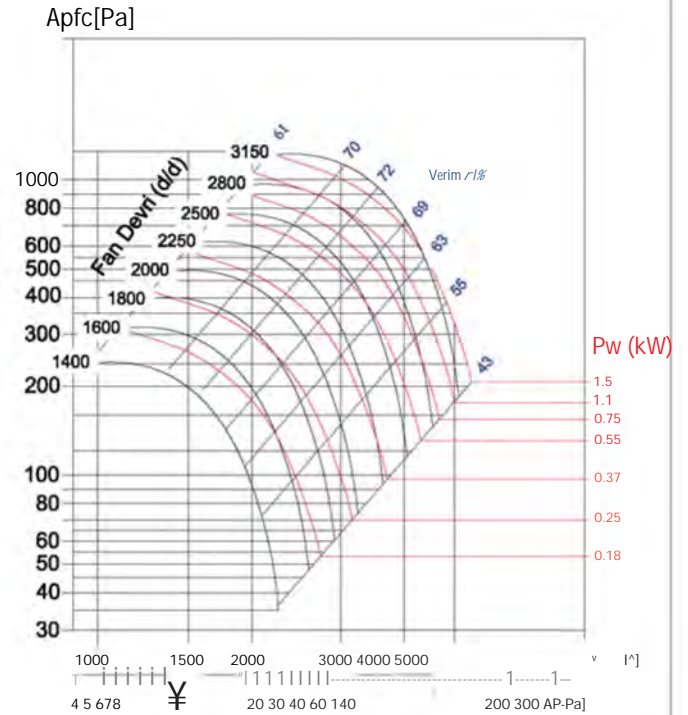

## BPF 355

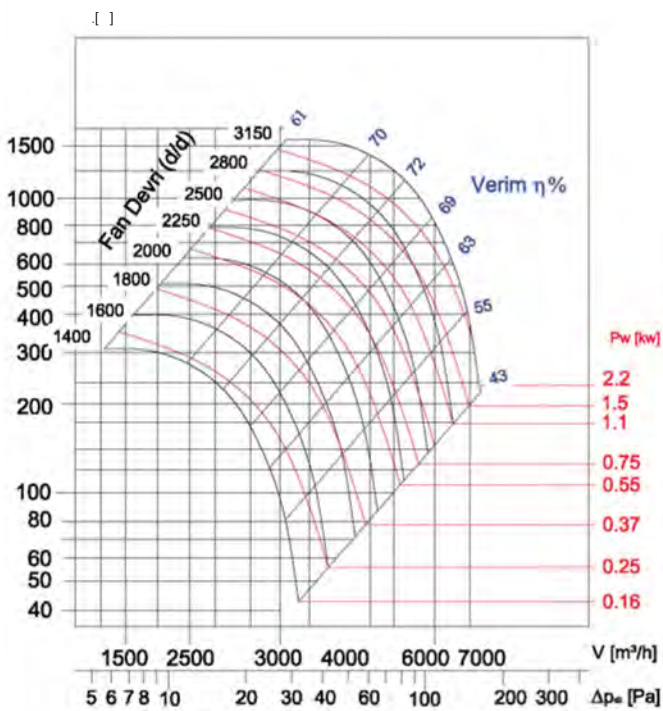

## BPF 400

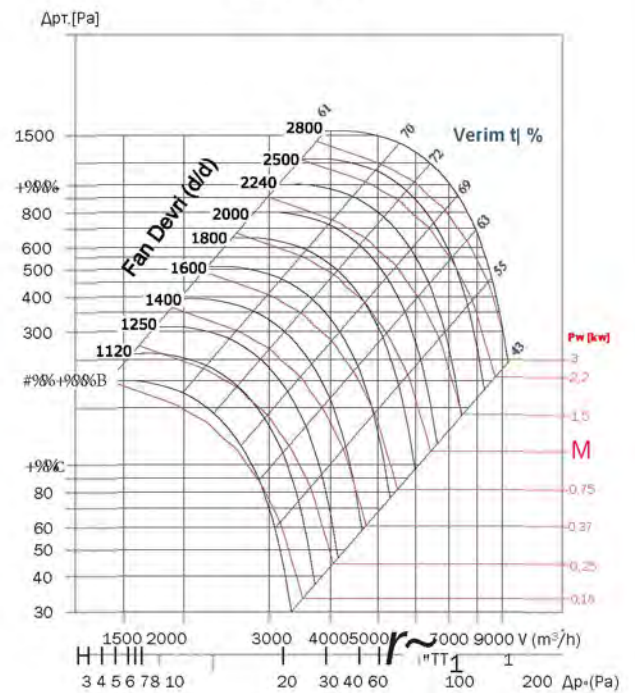



### BPF 450

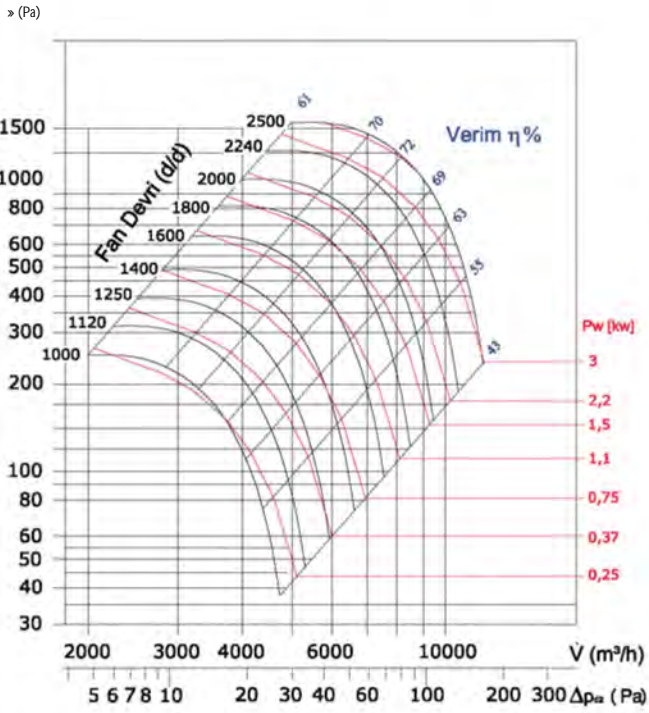

### BPF 500

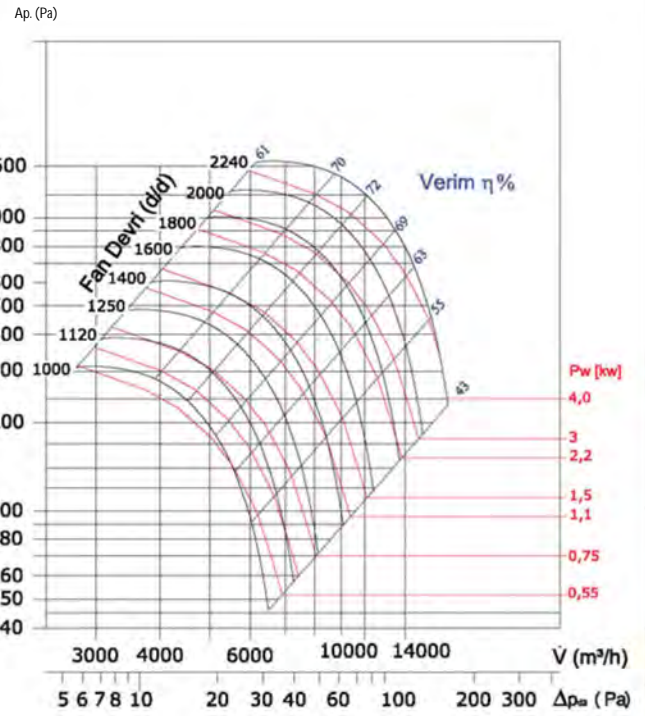

### BPF 560

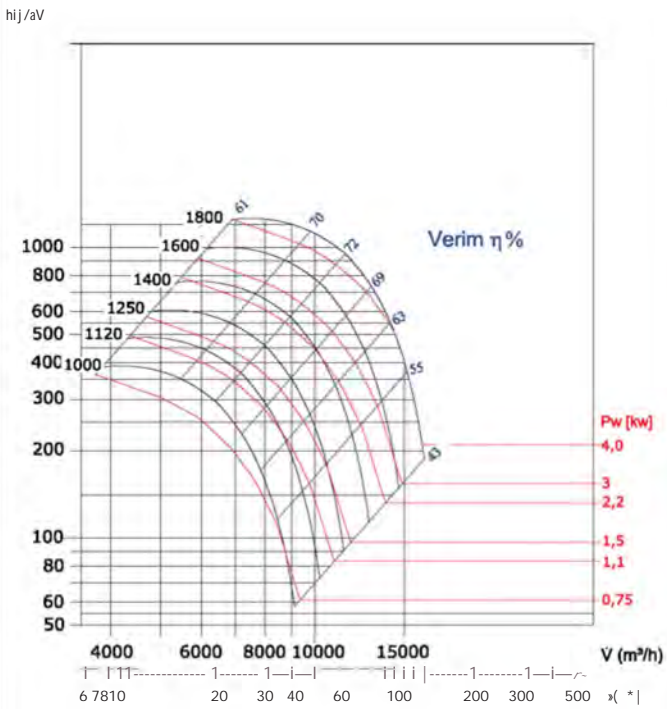

### Accessories



BSC-F

# RADIAL FANS

## ALQ

AC LOW PRESSURE CENTRIFUGAL FANS



More air with low static pressure.

Air flow: 1500 -10.000 m<sup>3</sup>/h

Pressure: 100-750 Pa

Directly coupled motor.(single-phase, three-phase)

Due to it's special screwing feature, plate can be turned in any blowing position.



MATERIAL

- Casing is made of galvanized sheet metal.
- Impeller is made with special designed backward curved metal sheet.

INSULATION CLASS

- Class F

DIRECTIVE

- EN 60335-1, EN 60335-2-80

SPEED CONTROL

- Speed can be adjusted using an optional controller.

APPLICATION AREAS

- Various Ventilation, Heating and cooling applications, where high volume of air flow needed at minimum pressure.

### Technical Drawings

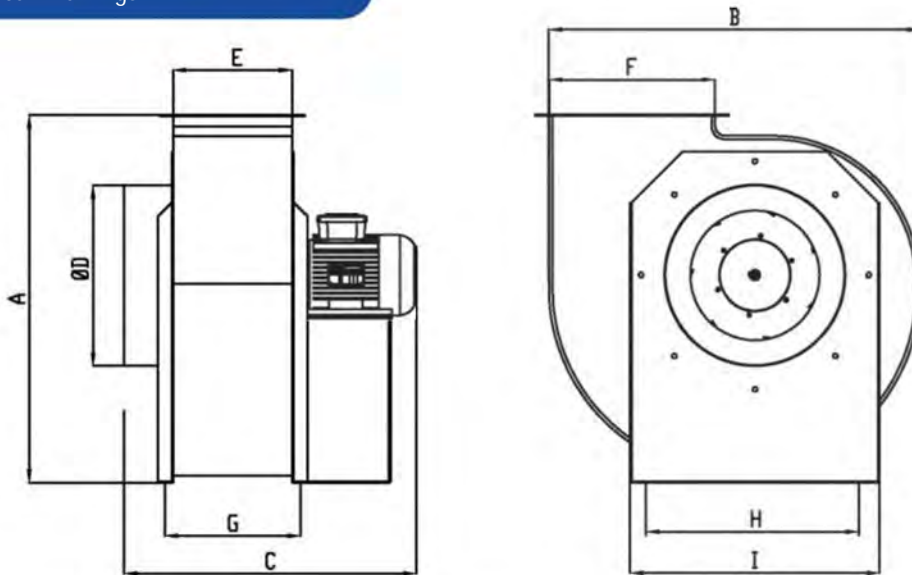

TYPE	A	B	C	D	E	F	G	H	I
315	595	567	450	250	176	256	219	319	380
355	670	639	456	300	182	286	224	359	419
400	745	720	568	350	221	316	265	424	484
450	830	810	587	350	236	356	278	465	525
500	930	906	650	427	279	400	322	524	584
560	1030	1015	703	470	313	448	354	604	704

Dimensions are in (mm)



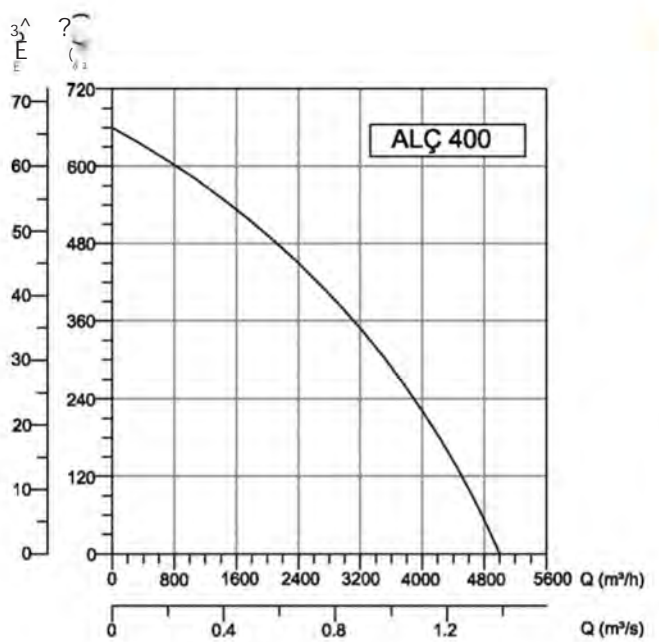
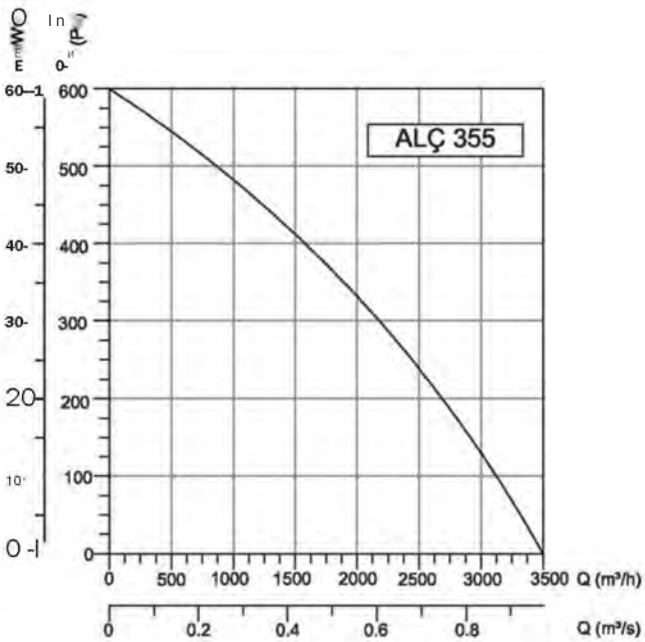
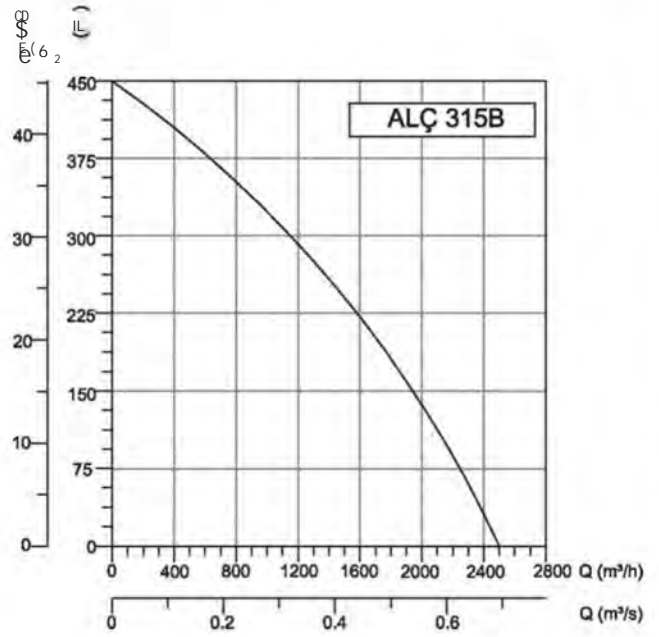
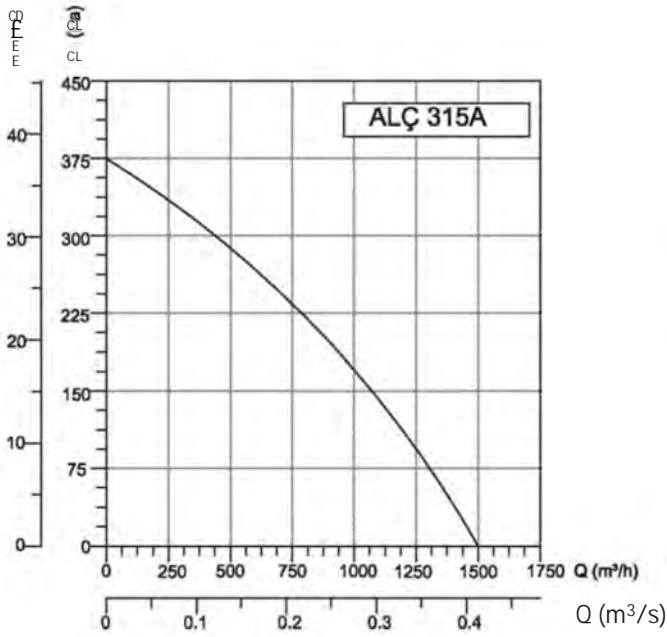

TYPE	V	Hz	Power (Kw)	Cent (A)	d/d	Flow (m³/h)	Sound Power Level (dB(A))	Weight (kg)
ALQ 315 A-M / 315-T	230/380	50	0,25	1,6/0,67	1450	1500	50	22
ALQ 315 B-M/315-T	230/380	50	0,37	2,5/1,05	1420	2500	50	22
ALQ355-M / 355-T	230/380	50	0,55	3,5/1,27	1450	3500	53	32
ALQ 400-M / 400-T	230/380	50	0,75	5/18	1450	5000	70	41
ALQ450-M / 450-T	230/380	50	1,1	7/2,4	1450	6000	72	50
ALQ 500-M / 500-T	230/380	50	1	7/2,4	1420	8000	75	62
ALQ 560-M / 560-T	230/380	50	1,5	9 /33	1400	10000	75	77

# RADIAL FANS

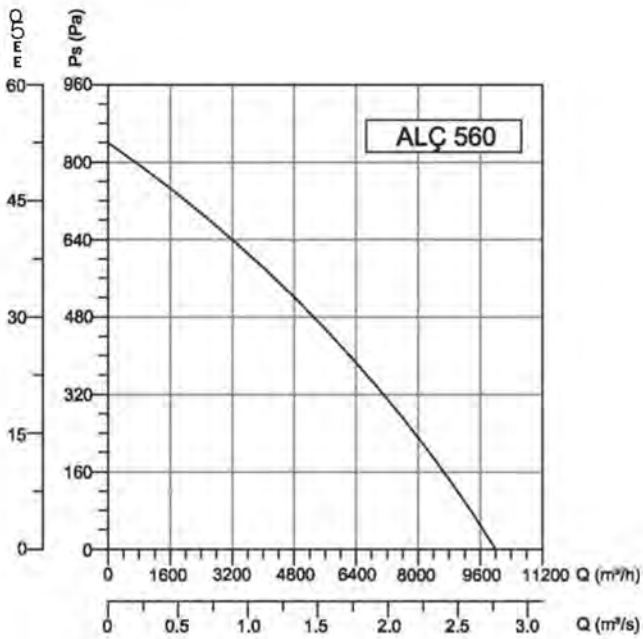
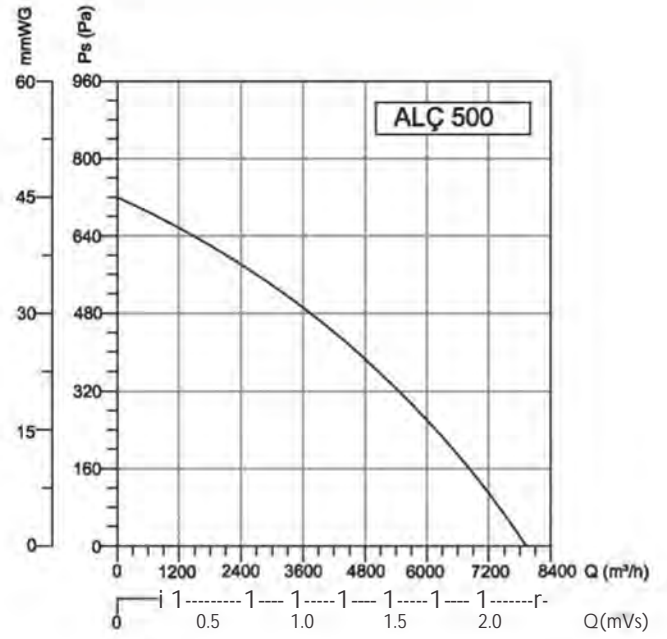
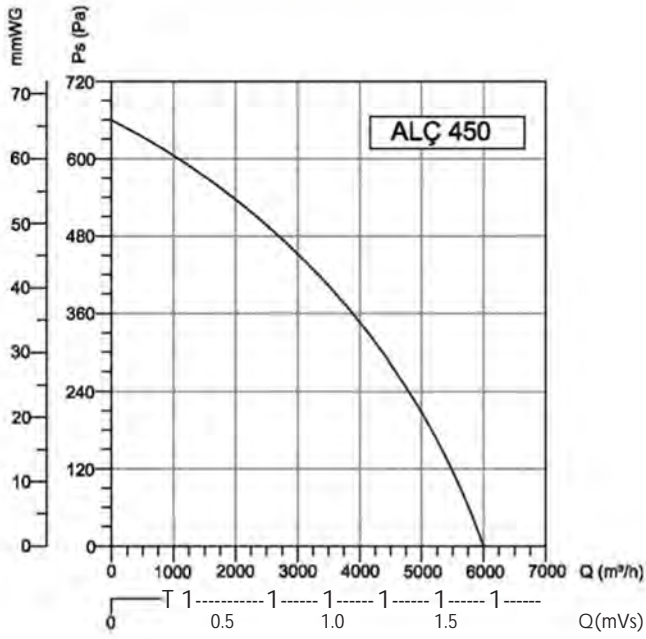

## Accessories



BSC-F



## SUCTION - BLOWING DIRECTIONS

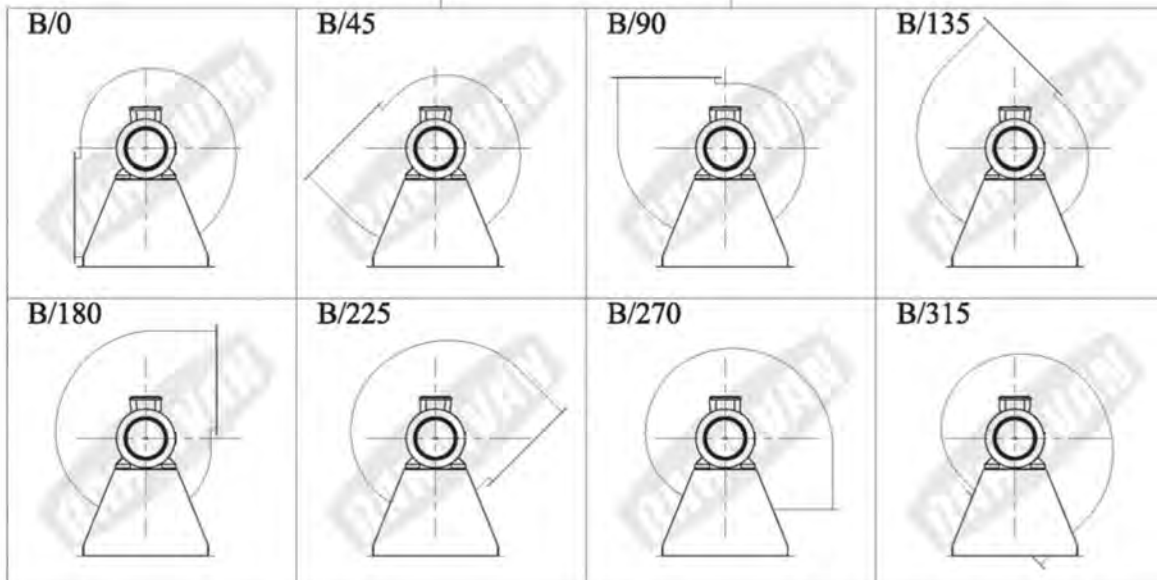
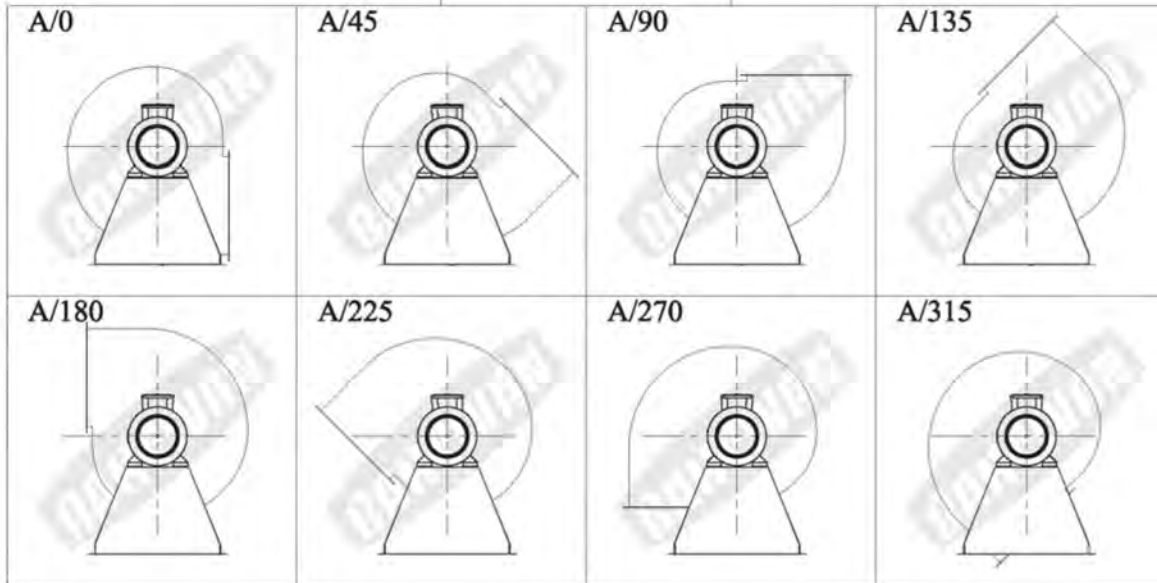

# RADIAL FANS



# BGSS

AC      LOW      PRESSURE      CENTRI      FUGAL      FANS

Backward Curved, Large Blade

BGSS supply highest air flow at low static pressure.

Flowrate: 3500 - 40000 m<sup>3</sup>/h

Pressure: 40 - 280 mm WG

Direct coupled to motor (single phase-three phase)

## Technical Drawings

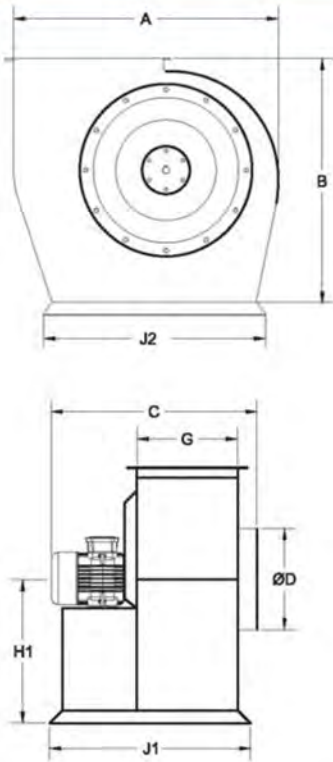

MATERIAL

: Housing is made electrostatic powder coated sheet metal, backward curved fan is made of sheet metal.

INSULATION CLASS

: Class F

DIRECTIVE

: EN 60335-1, EN 60335-2-80

SPEED CONTROL

: Speed can be adjusted using an optional controller.

APPLICATION AREAS : For clean air suction, industrial areas,

residential and industrial air conditioning systems, shelter, mine, tunnel ventilation, junk depots and barns, to cool plastic, cloth and glass boards, to dry fodder, paper, grain, varnish, woodens and to separate bad smell gases and toxic gases etc.

TYPE	A			OD	G	H1	J1	J2	OUTLET DIMENSIONS a b	
BGSS 1	648	602	524	350	240	355	490	480	352	246
BGSS 2	750	671	570	400	260	400	530	520	402	266
BGSS 3	880	782	660	450	320	462	615	600	452	326
BGSS 4	880	782	685	480	340	462	635	600	452	346
BGSS 5	960	862	750	500	350	515	690	640	502	356
BGSS 6	1051	939	780	560	370	555	710	680	563	378
BGSS 7	1051	939	865	600	390	555	760	730	563	398
BGSS 8	1160	1060	915	630	410	680	820	810	633	418
BGSS 9	1160	1060	975	680	430	680	880	860	633	438
BGSS 10	1322	1205	1090	710	460	730	1070	970	713	468
BGSS 11	1322	1205	1160	760	490	730	1160	970	713	498
BGSS 12	1491	1295	1230	800	520	825	1180	1030	803	528
BGSS 13	1491	1295	1290	830	540	825	1250	1030	803	548

Dimensions are in (mm)

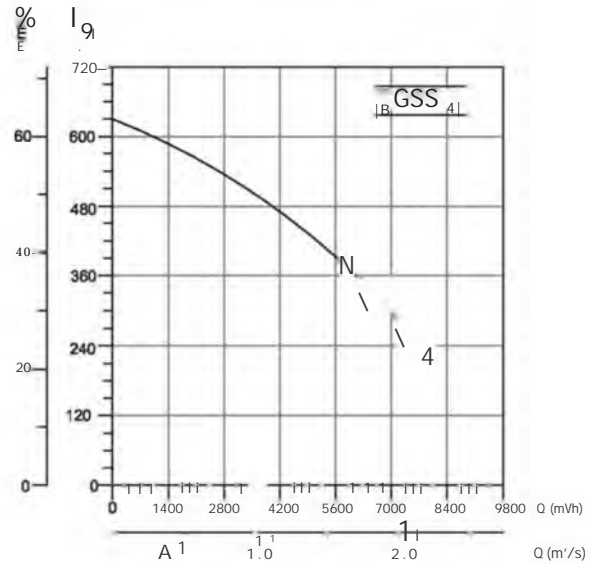
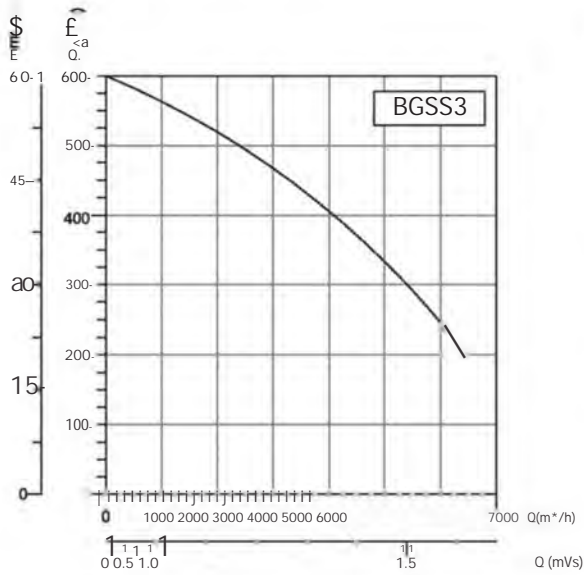
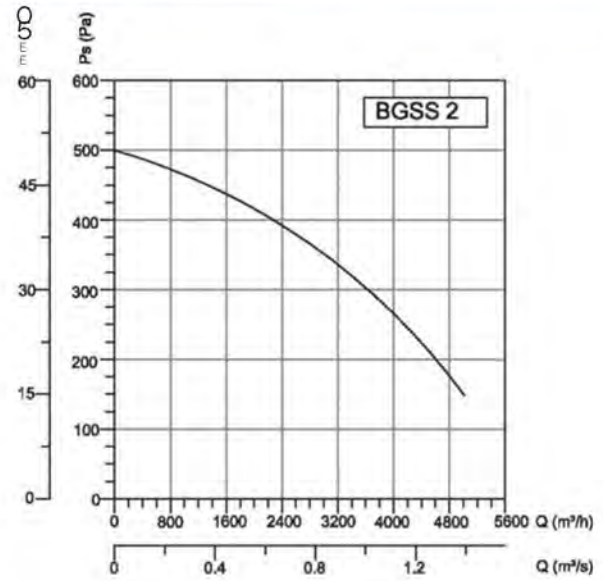
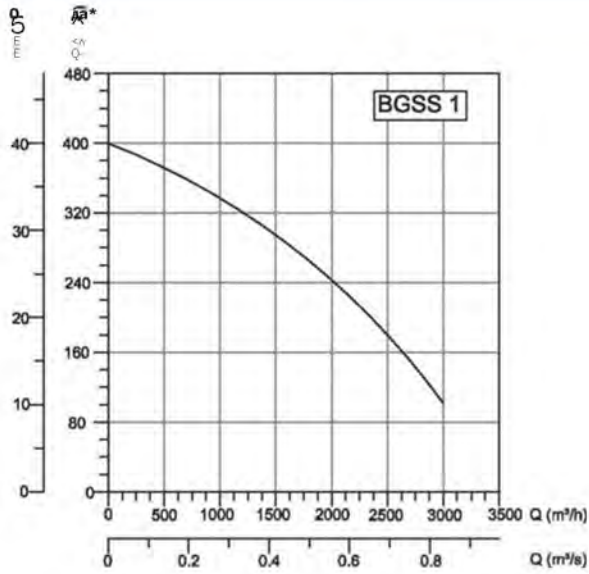

TYPE	VOLTAGE	FREQUENCY	POWER	SPEED	AIR FLOW	PRESSURE
	V	Hz	Kw	d/d	m³/h (max)	Pa (max)
BGSS 1	230/380	50	0,37	1400	3500	400
BGSS 2	230/380	50	0,75	1400	5000	500
BGSS 3	230/380	50	1,1	1400	6500	600
BGSS 4	230/380	50	1,5	1400	8000	700
BGSS 5	230/380	50	2,2	1400	9000	750
BGSS 6	230/380	50	3	1400	13000	1000
BGSS 7	380	50	4	1400	15000	1100
BGSS 8	380	50	5,5	1400	18000	1250
BGSS 9	380	50	7,5	1400	21000	1500
BGSS 10	380	50	11	1400	25000	1700
BGSS 11	380	50	15	1400	28000	1900
BGSS 12	380	50	18,5	1400	32000	2000
BGSS 13	380	50	22	1400	40000	2200

# RADIAL FANS

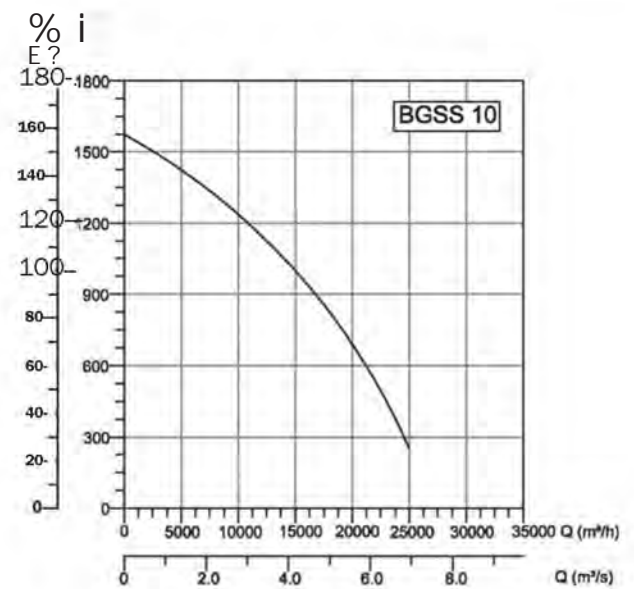
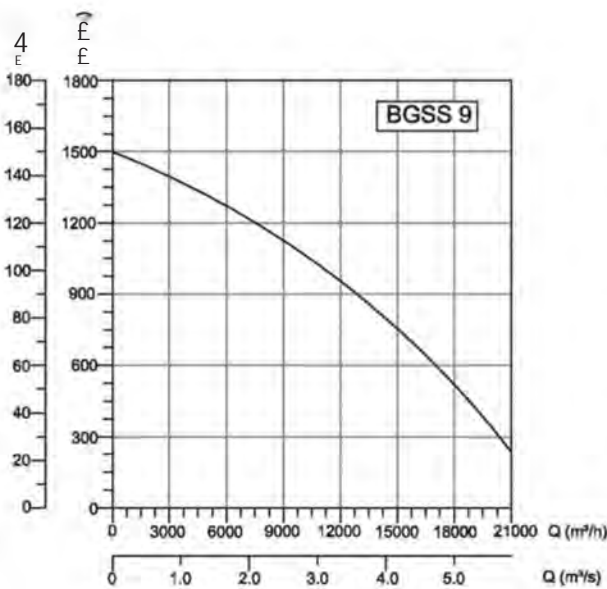
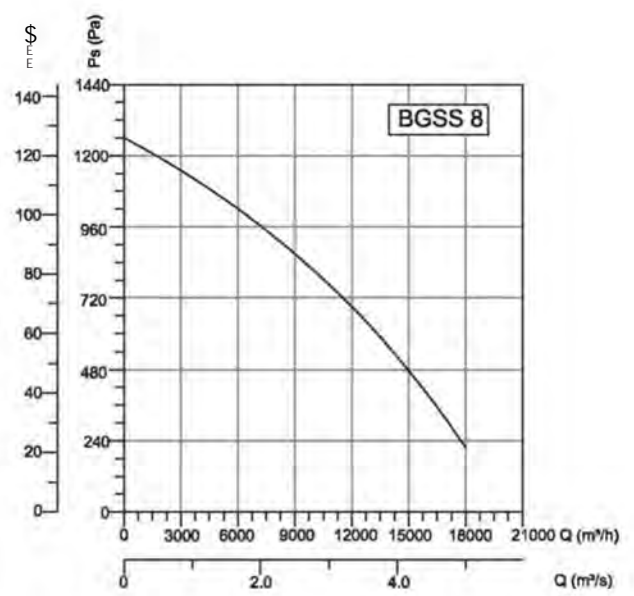
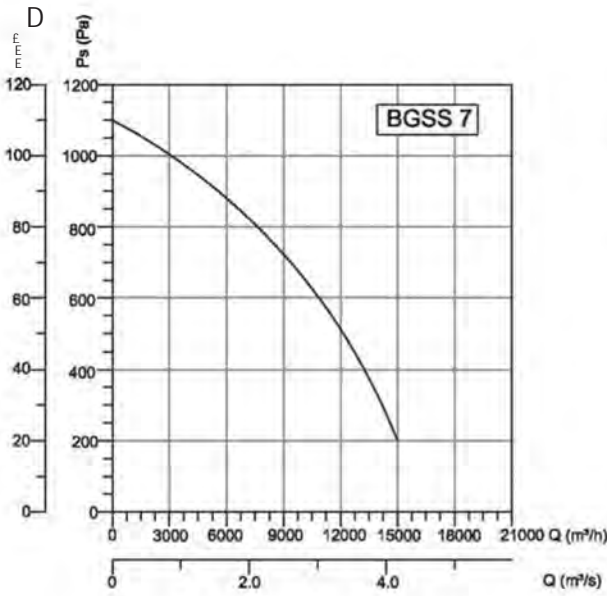
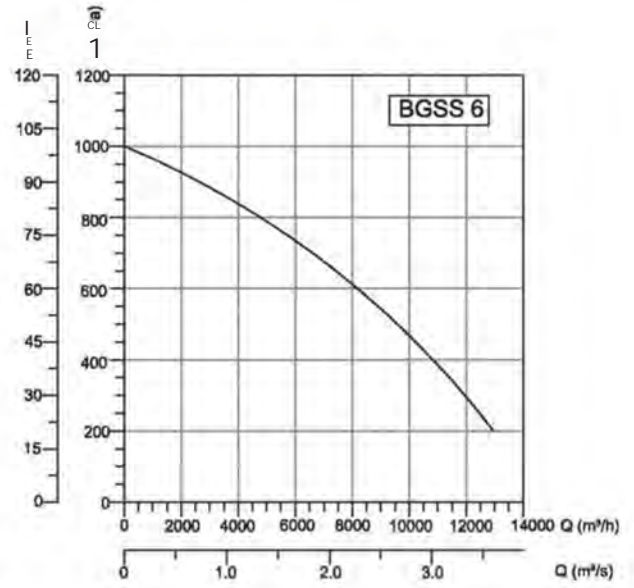
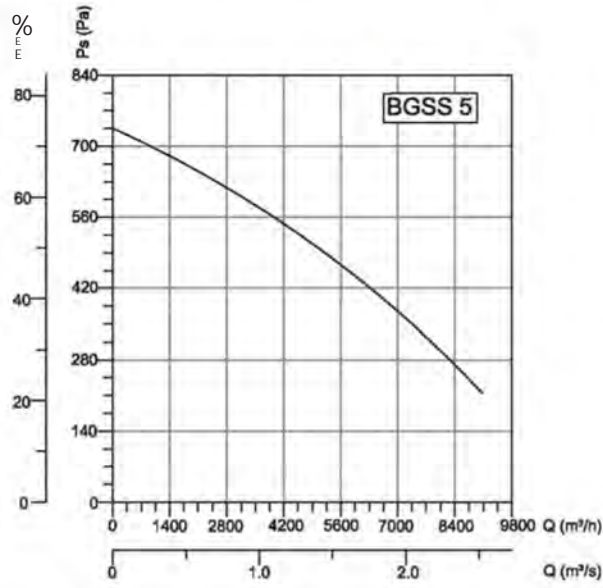



BVN

VENTILATION & CLIMATE CONTROL

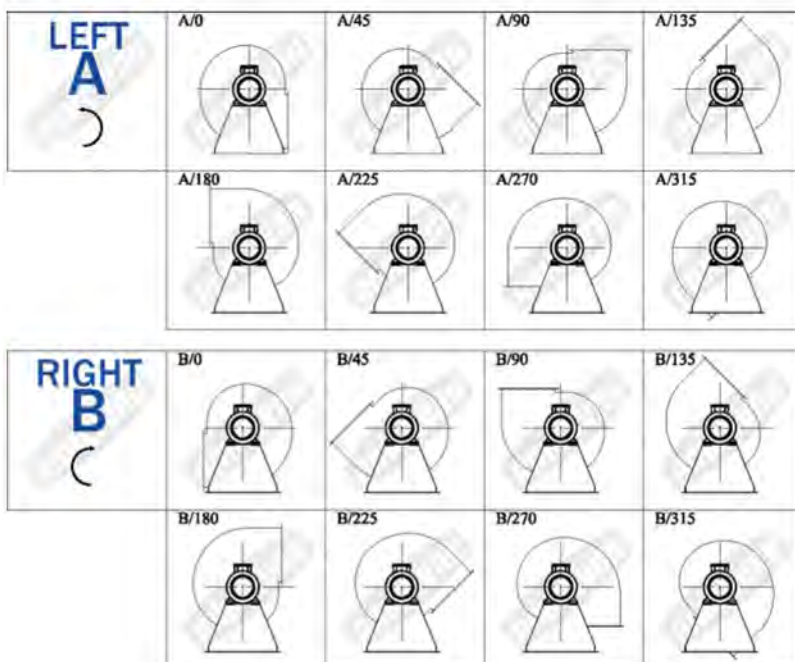
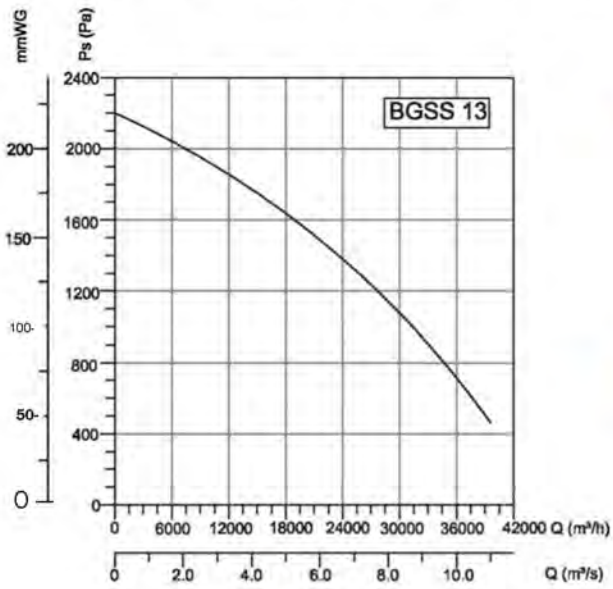
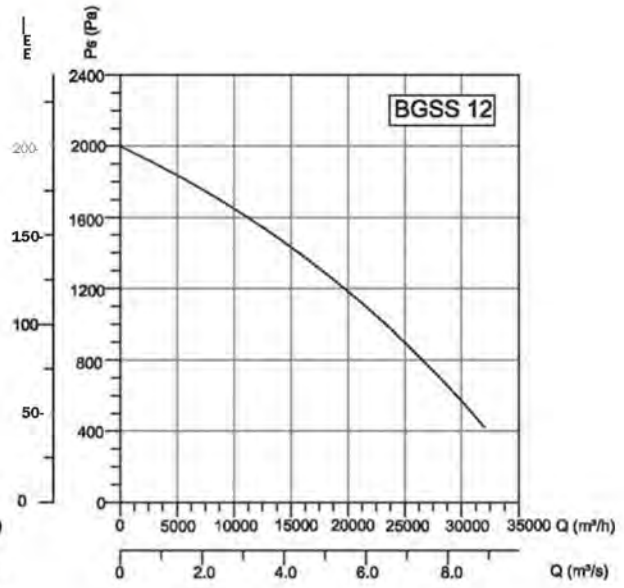
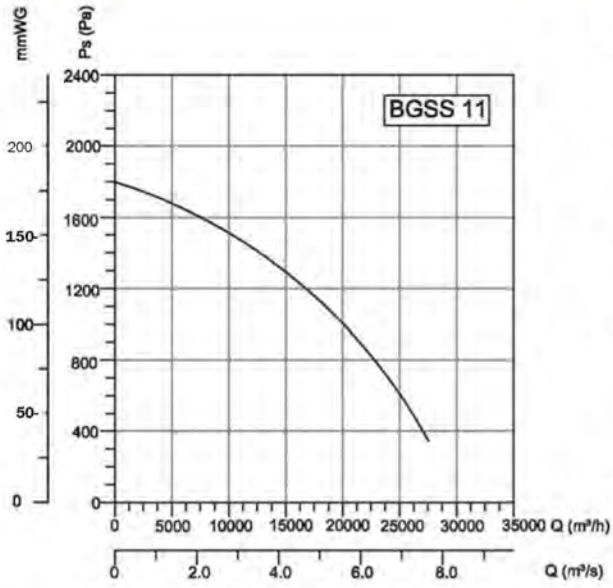

# RADIAL FANS



# BORKA

AC MEDIUM PRESSURE CENTRIFUGAL FANS

Backward Curved

BORKA Fans work higher speeds and have backward curved impeller,  
They provide high air volumes at higher static pressures,  
Reinforced body, direct coupled motor,

## Technical Drawings

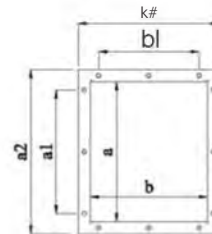
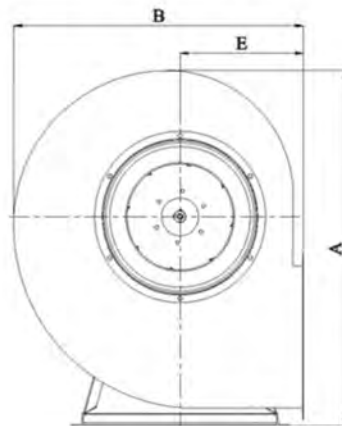
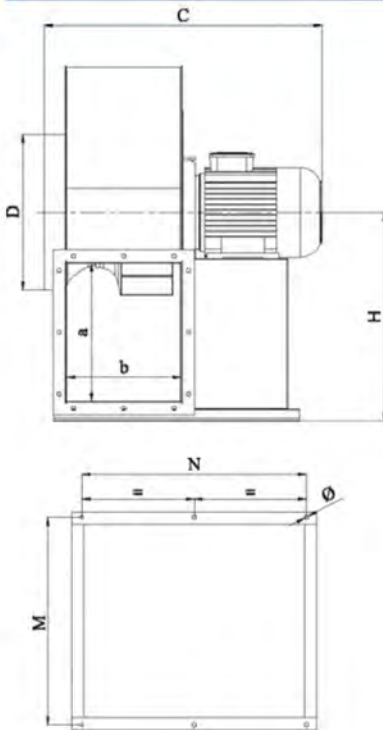

### MATERIAL

### INSULATION CLASS

### DIRECTIVE

### SPEED CONTROL

### APPLICATION AREAS

- Housing is made of sheet steel, backward curved radial fan is made of sheet metal,
- Class F
- EN 60335-1, EN 60335-2-80
- Speed can be adjusted using an optional controller.
- Dusty and air with small particles transferred areas, wooden and metallic chippings suction, textile, ceramic, cement industry and pneumatic transferring chemical operations,

TYPE A			D	E	H	HI	M	N	a	b	a1	bl	a2	b2	0
BORKA 250 564	440	465	235	182	351	301	310	403	214	172	174	120	274	232	10
BORKA 280 614	493	485	260	203	376	330	356	423	240	212	200	160	300	272	10
BORKA 315 A 680	554	541	320	239	412	352	412	450	272	230	232	190	332	290	10
BORKA 315 680	554	541	320	239	412	352	412	450	272	230	232	190	332	290	10
BORKA 355 A 773	625	575	325	275	463	398	456	482	307	260	266	220	367	320	10
BORKA 355 773	625	575	325	275	463	398	456	482	307	260	266	220	367	320	10
BORKA 400 A 865	704	658	375	300	508	453	506	547	341	285	301	245	401	345	10
BORKA 400 865	704	674	375	300	508	453	506	547	341	285	301	245	401	345	10
BORKA 450 A 976	791	756	414	337	575	505	586	620	384	310	344	270	444	370	10
BORKA 450 976	791	756	414	337	575	505	586	620	384	350	381	310	481	410	10
BORKA 500 A 1083 850	796	454	355	635	545	636	701	421	421	350	381	310	481	410	10
BORKA 500 1083 850	912	454	355	635	545	636	811	421	421	350	381	310	481	410	10
BORKA 560 A 1196 955	952	497	400	693	600	726	852	472	472	390	432	350	532	450	10
BORKA 560 1196 955	952	497	400	693	600	726	852	472	472	390	432	350	532	450	10

Dimensions are in (mm)



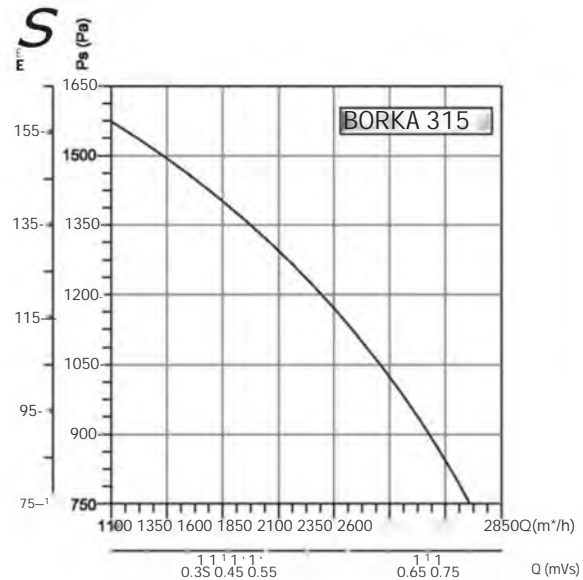
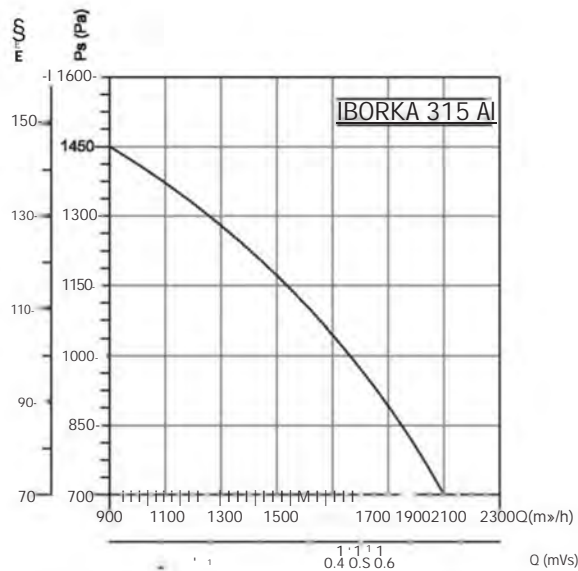
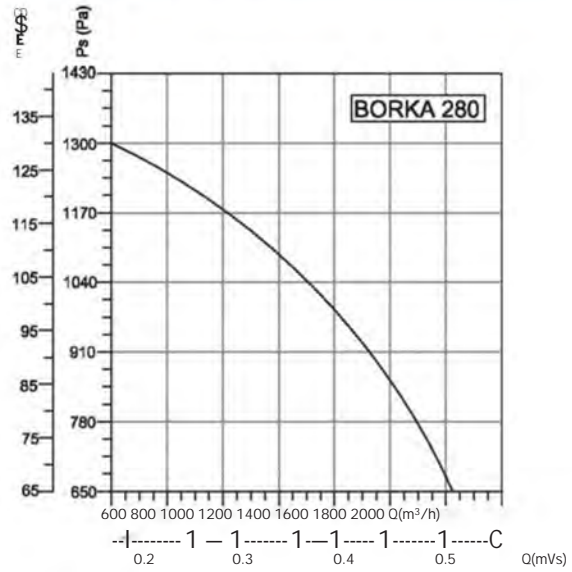
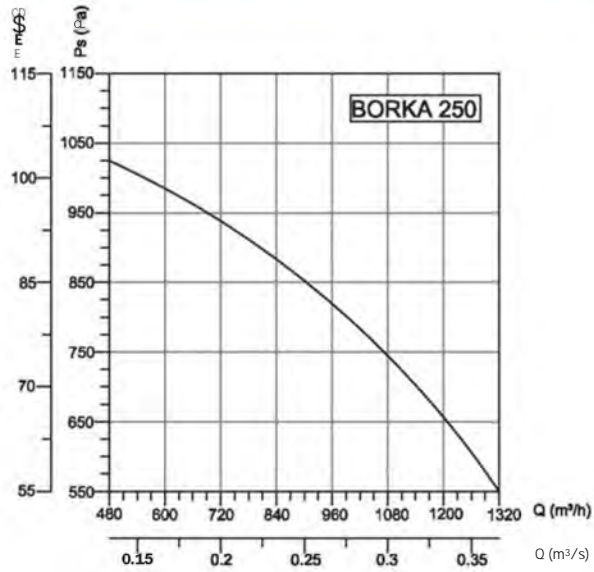

TYPE	ELECTRICITY		MOTOR TYPE	P <sub>1</sub> KW	Q <sub>E</sub> d/d	L <sub>L</sub> m³/h	L <sub>DB</sub> Pa	z a 3 kg
	V	Hz						
BORKA 250	230/380	50	71	0,37	2750	1000	900	20
BORKA 280	230/380	50	71	0,55	2750	1500	1000	28
BORKA 315 A	230/380	50	80	0,75	2830	1700	1150	32
BORKA 315	230/380	50	80	1,1	2830	2150	1200	32
BORKA 355 A	230/380	50	90S	1,5	2850	2750	1500	44
BORKA 355	230/380	50	90L	2,2	2850	2900	1950	47
BORKA 400 A	230/380	50	100L	3	2900	4100	2000	59
BORKA 400	380	50	112M	4	2900	4800	2200	60
BORKA450 A	380	50	132S	5,5	2900	5100	2400	80
BORKA 450	380	50	132S	7,5	2900	6500	2900	81
BORKA 500 A 380		50	132S	7,5	2900	7400	3300	102
BORKA 500	380	50	160M	11	2930	8600	3700	120
BORKA 560 A	380	50	160M	15	2930	11000	3750	140
BORKA560B 380		50	160L	17,5	2930	13200	4300	145

ICE FANS

WALL FANS

A WALL FAN

RADIAL FANS

CONE

QV

VENTILATORS

SMOKE EXHAUST

1 2

ACCESSORIES

# RADIAL FANS

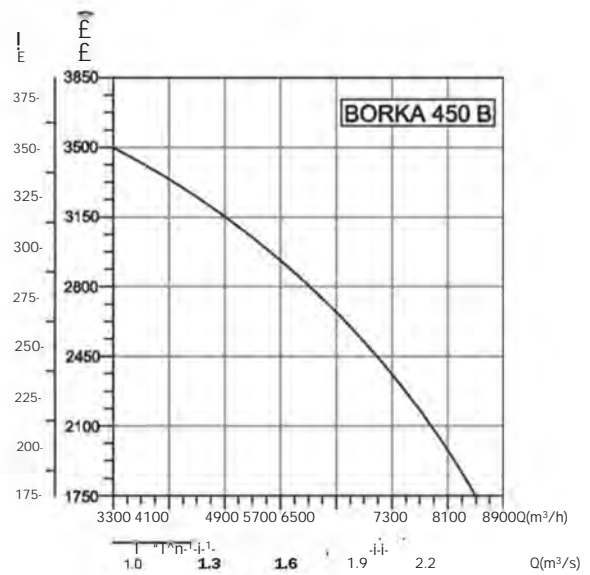
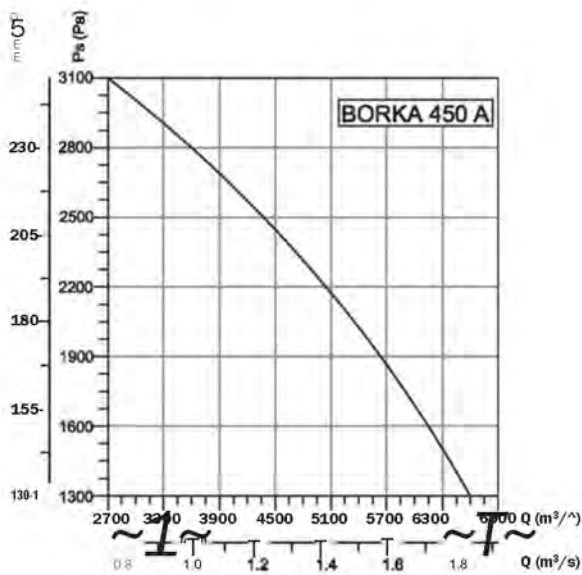
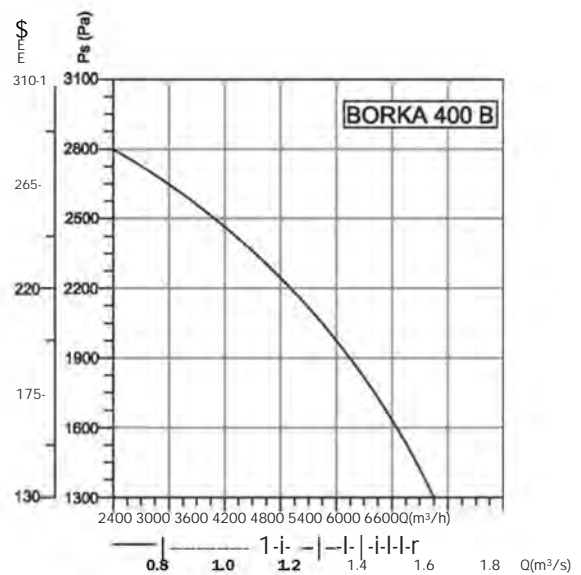
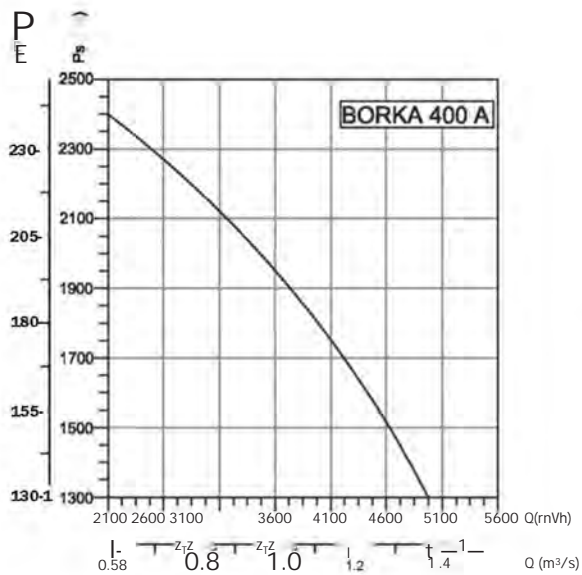
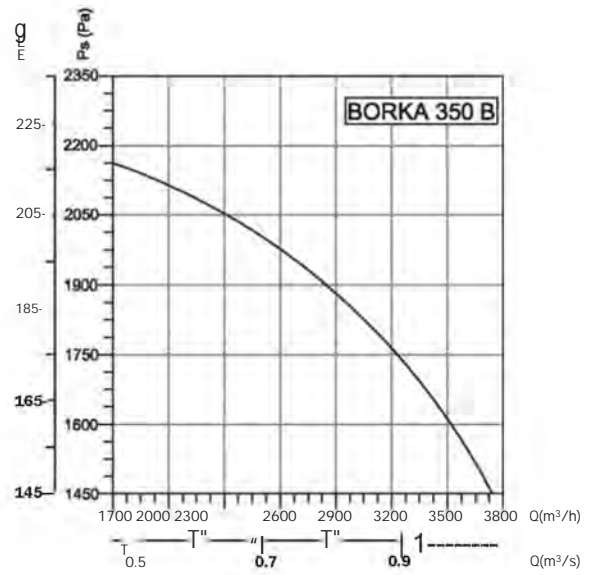
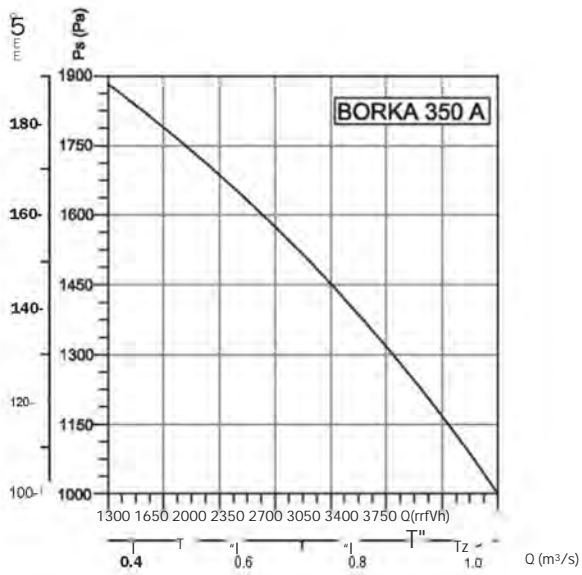

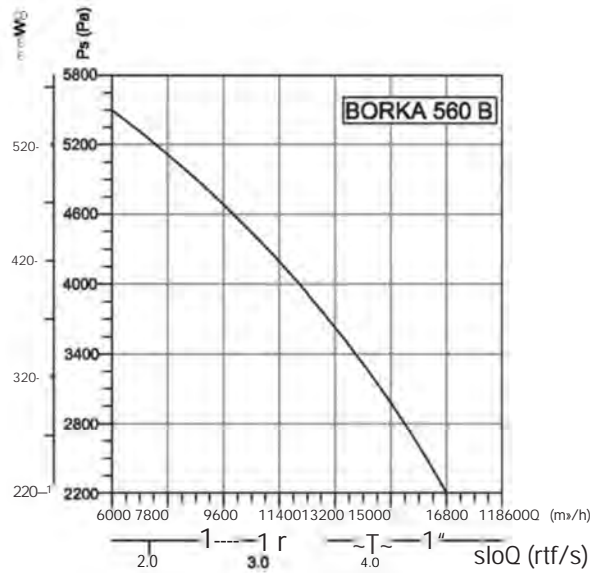
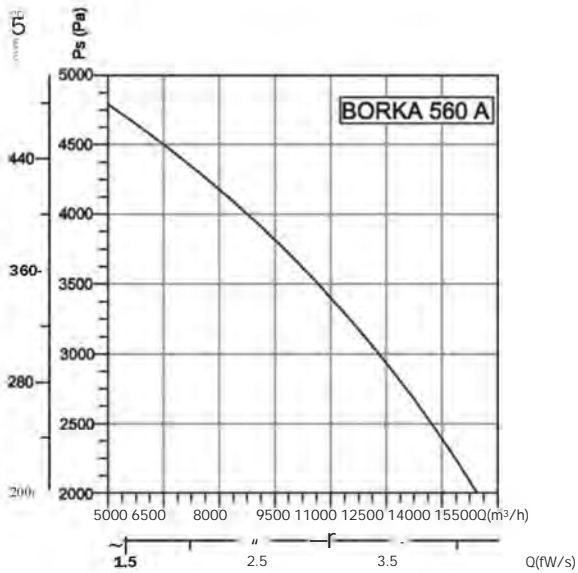
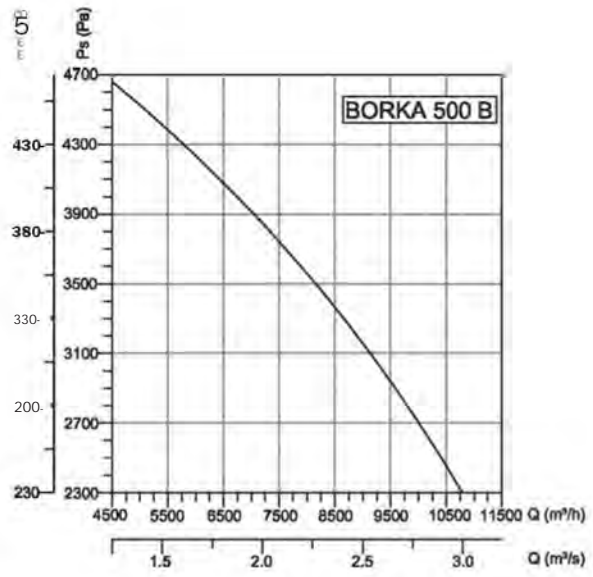
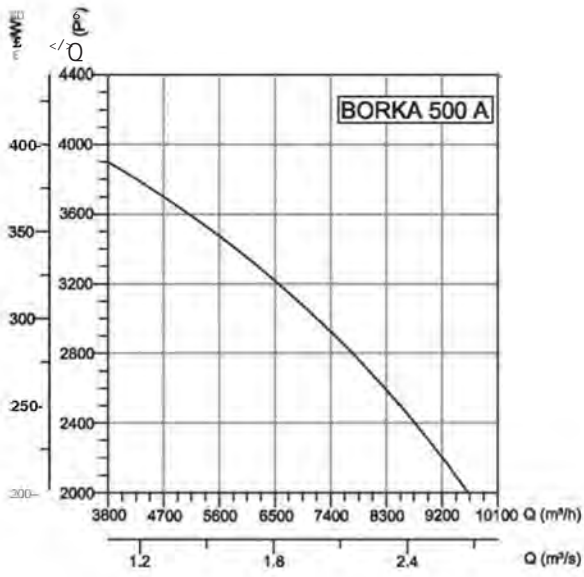

## SUCTION - BLOWING DIRECTIONS

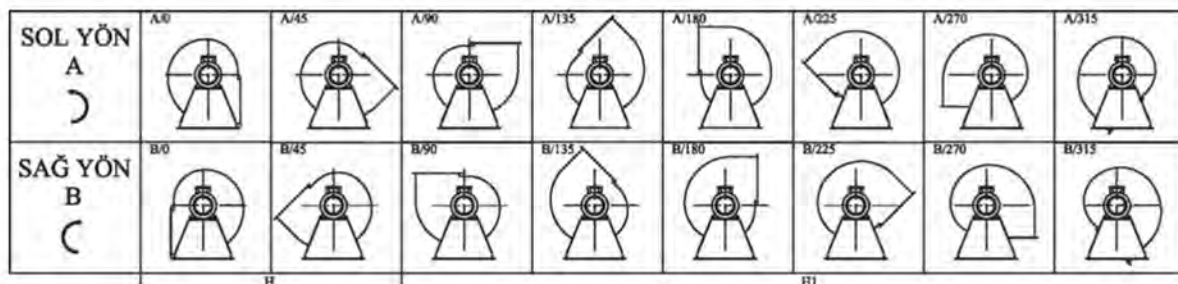

# RADIAL FANS

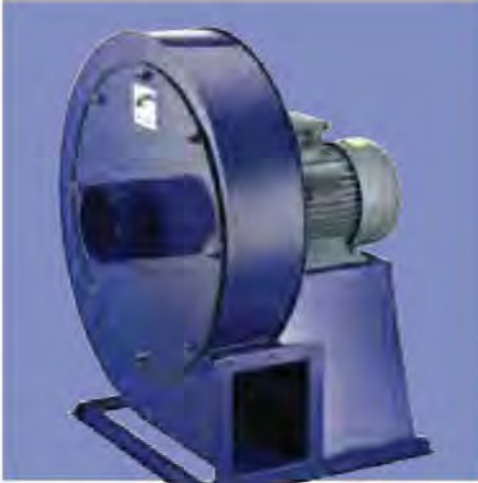

# ORB

AC MEDIUM PRESSURE CENTRIFUGAL FANS

Under middle and high static pressure, gives high performance,  
 Flowrate: 950 - 4000 m<sup>3</sup>/h  
 Pressure: 130- 725 mmWG  
 Direct coupled motor (single phase - three phase)

## Technical Drawings

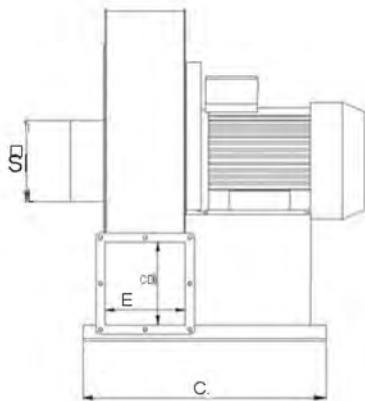
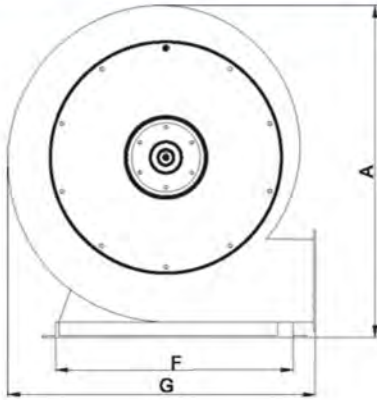

- MATERIAL** : Housing is made of electrostatic powder coated sheet metal, impeller is made of galvanized sheet metal,
- INSULATION CLASS** : Class F
- DIRECTIVE** : EN 60335-1, EN 60335-2-80
- SPEED CONTROL** : Speed can be adjusted using an optional controller,
- APPLICATION AREAS** : Where marble dust, small chips, granite, plastic saw's dust, wooden and metal chips etc, must be transported, every place where middle pressure air flow is needed,

TYPE	A			D	E	F	G
ORB 1	430	95	340	120	100	320	380
ORB 2	500	95	340	120	100	370	380
ORB 3	560	95	340	120	100	390	400
ORB 4	590	110	420	150	120	450	600
ORB 5	650	110	440	150	120	450	600
ORB 6	670	140	520	150	150	450	700
ORB 7	760	140	550	150	150	510	750
ORB 8	810	140	600	150	150	630	800
ORB 9	830	140	640	180	150	630	850

Dimensions are in (mm)

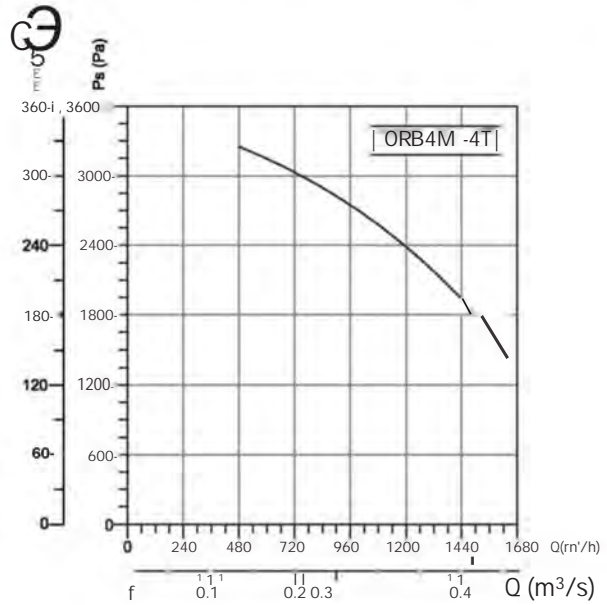
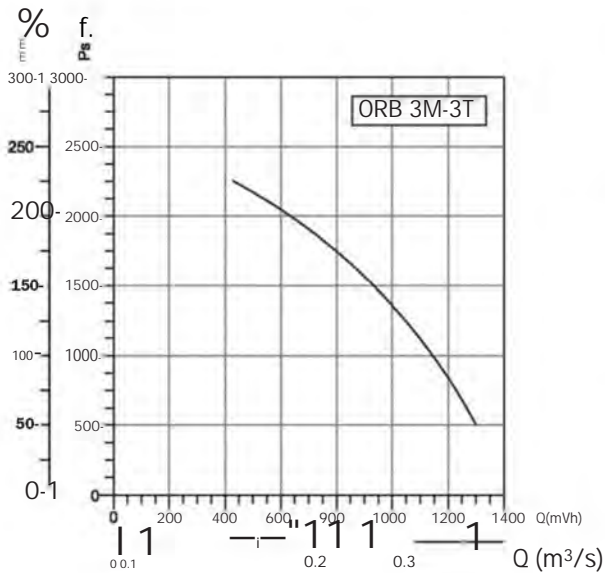
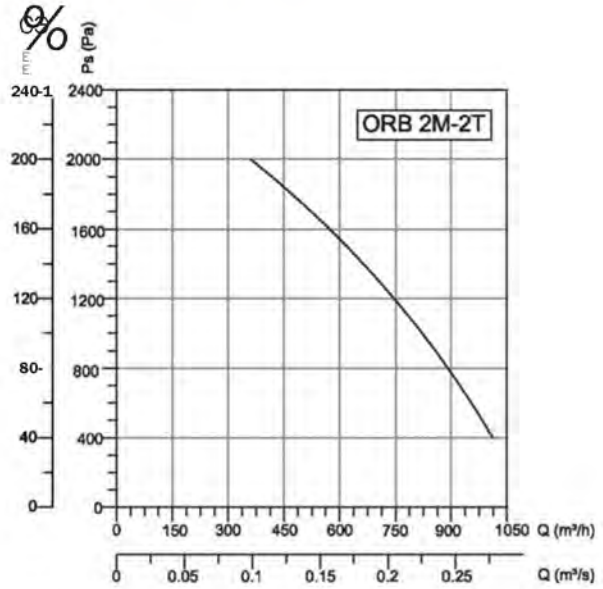
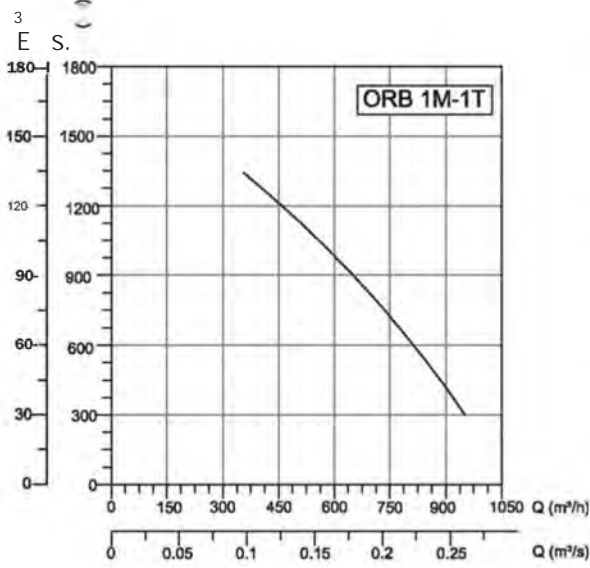

TYPE	VOLTAGE	FREQUENCY	DC	SPEED	AIR FLOW	STATIC PRESSURE	WEIGHT
	V	Hz	50				
ORB 1M-1T	230/380	50	0.37	2800	950	1300	20
ORB 2M-2T	230/380	50	0.75	2800	1000	2000	28
ORB 3M-3T	230/380	50	1.1	2800	1300	3000	42
ORB 4M-4T	230/380	50	1.5	2800	1500	3500	47
ORB 5M-5T	230/380	50	2.2	2800	1900	4000	58
ORB 6M-6T	230/380	50	3.0	2800	2200	4500	60
OBR7T	380	50	4.0	2800	2500	5000	67
OBR8T	380	50	5.5	2800	3000	6000	106
OBR	380	50	7.5	2800	4000	7250	134

# RADIAL FANS

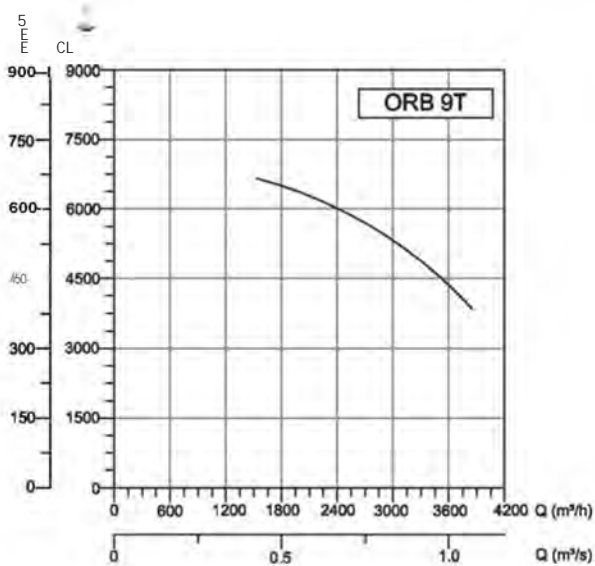
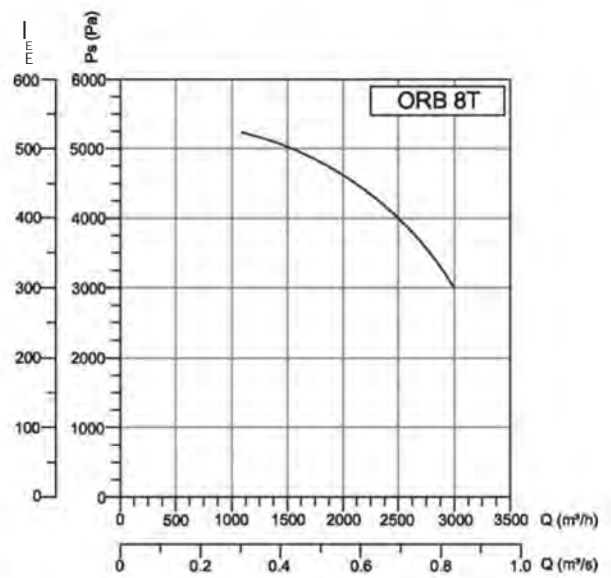
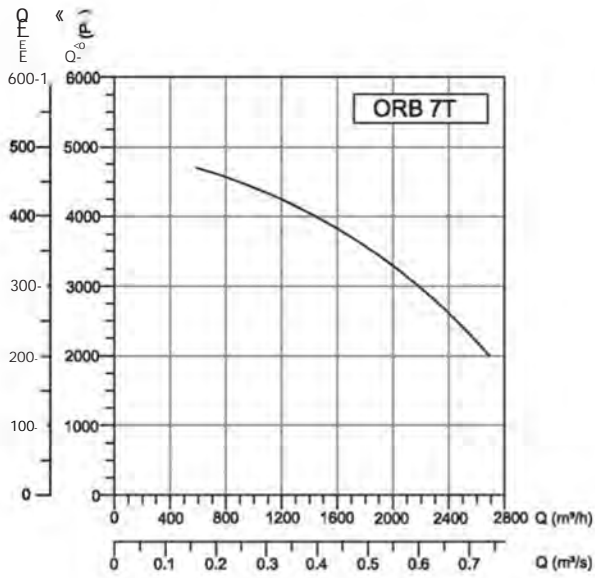
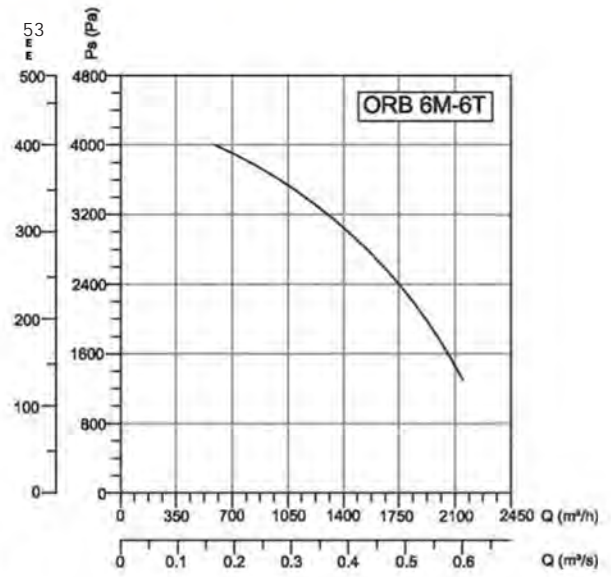
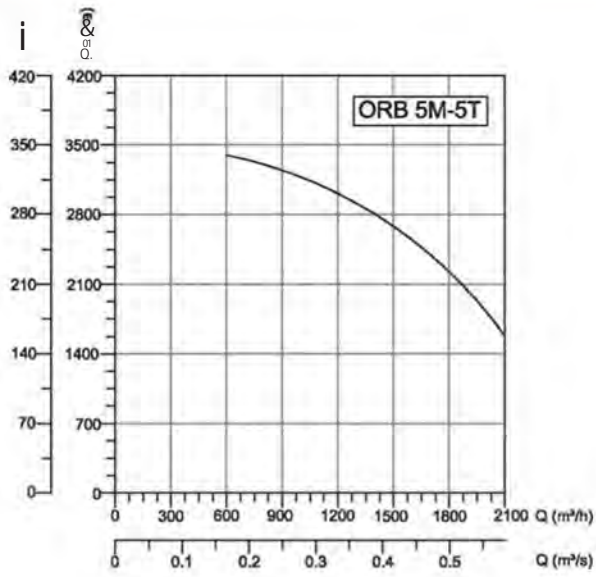

**Accessories**

**BSC-F**



# SUCTION - BLOWING DIRECTIONS

**LEFT**  
**A**  
)

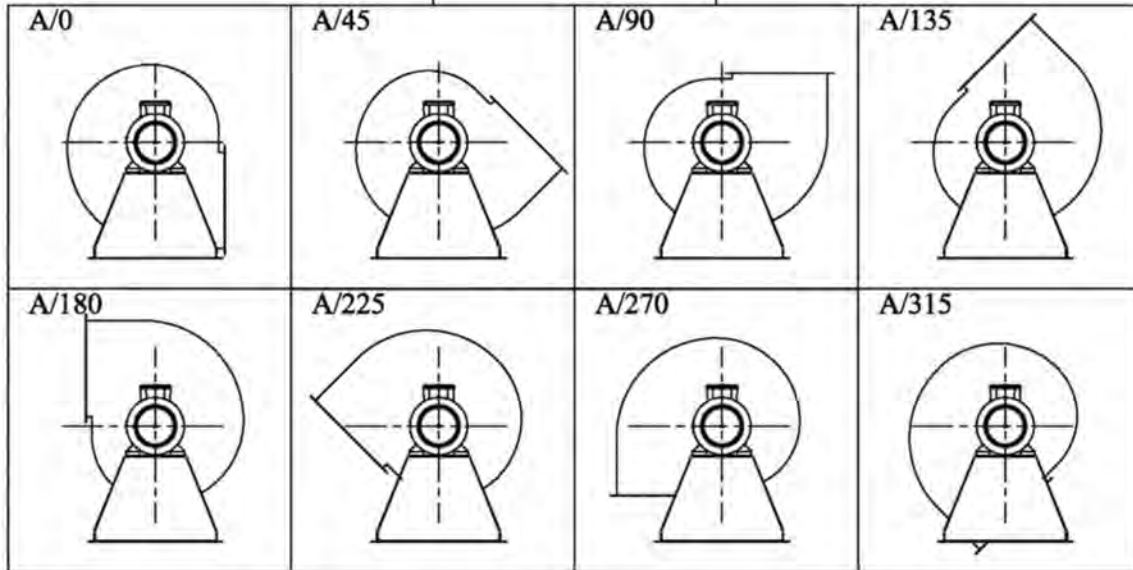

**RIGHT**  
**B**  
C

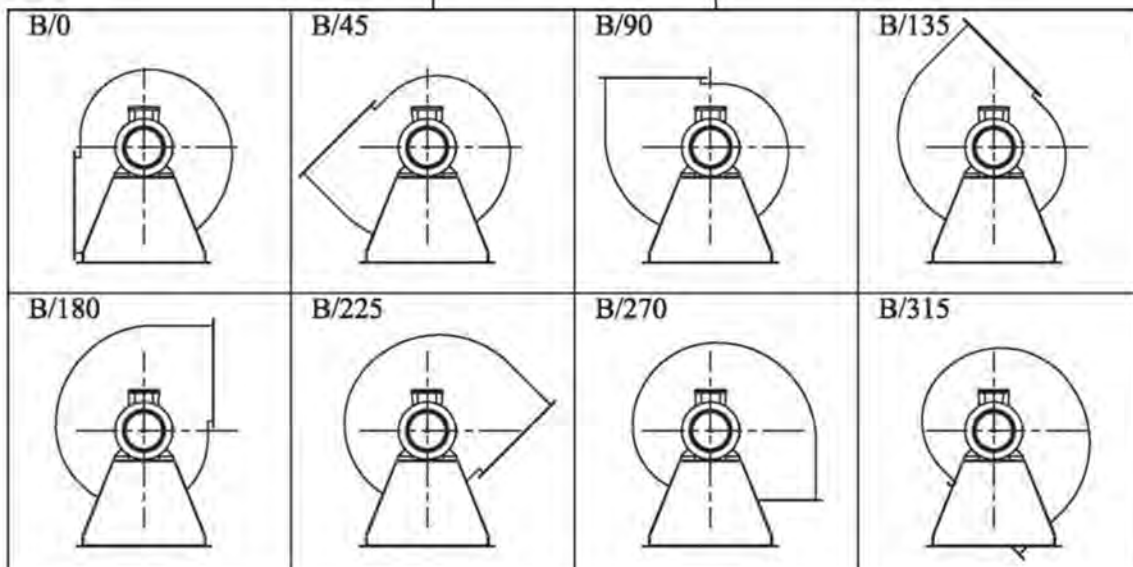

# RADIAL FANS



## YB

### AC HIGH PRESSURE CENTRIFUGAL FANS

Under low air flow with high pressure, works at highest performance.  
 Flowrate: 350 - 2000 m<sup>3</sup>/h  
 Pressure: 250 - 1000 mmWG  
 Direct coupled motor (single phase - three phase)

#### Technical Drawings

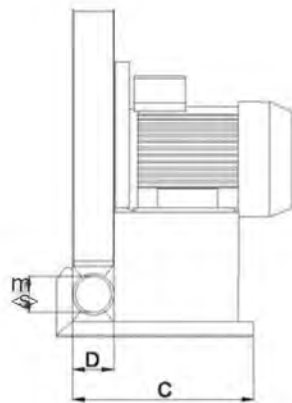
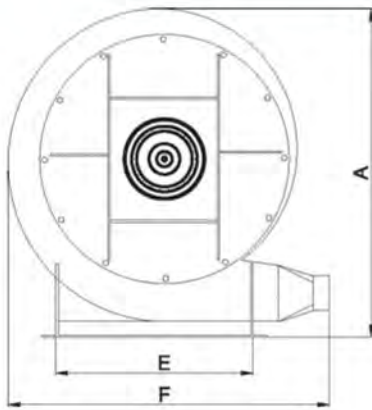

- MATERIAL** : Housing is made of electrostatic powder coated sheet metal, forward curved impeller is made of sheet metal,
- INSULATION CLASS** : Class F
- DIRECTIVE** : EN 60335-1, EN 60335-2-80
- SPEED CONTROL** : Speed can be adjusted using an optional controller,
- APPLICATION AREAS** : All kind of combustible burningsuch as Fuel- Oil, Gas etc, Pochette and printing machines, transferring materials by blowing out, wherever high pressure air flow is needed to working condition,

TYPE	A			D	E	F
YB 1	490	50	270	55	310	420
YB 2	570	50	290	55	370	490
YB 3	600	50	290	55	390	520
YB 4	640	50	340	55	430	560
YB 5	690	60	380	65	440	600
YB 6	700	70	440	75	460	600
YB 7	770	70	470	75	550	670
YB 8	810	70	530	75	620	720
YB 9	900	85	580	90	660	820

Dimensions are in (mm)



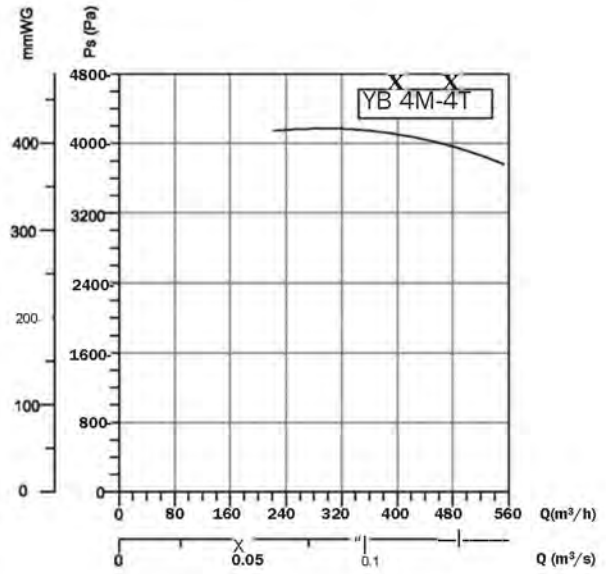
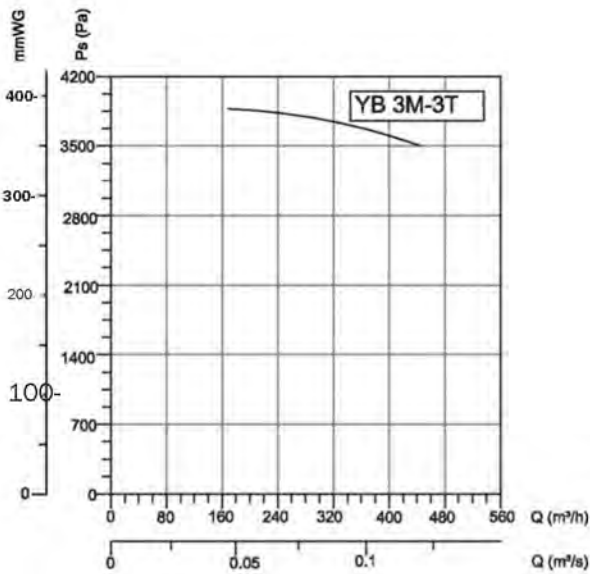
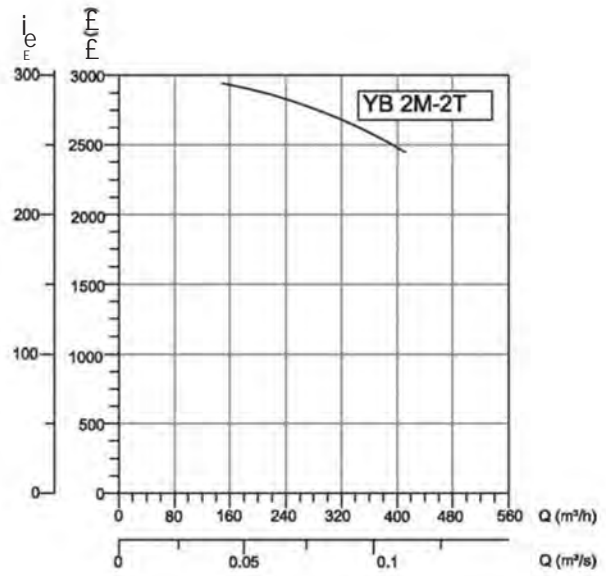
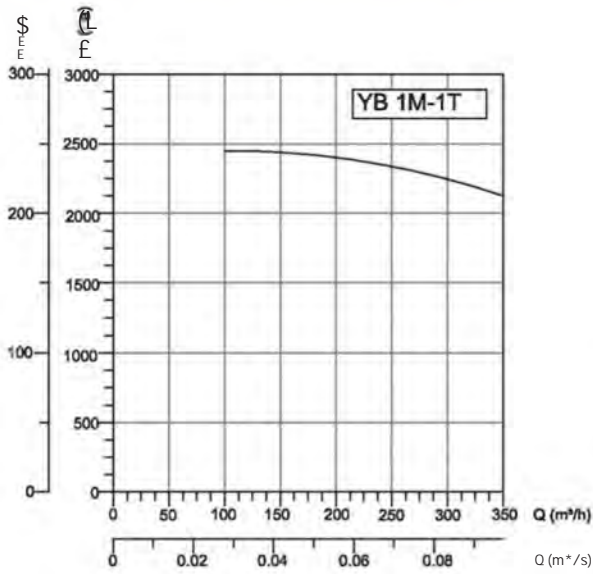

TYPE	CD	FREQUENCY	POWER	SPEED	AIR FLOW	STATIC PRESSURE	WEIGHT
	v <sub>L-T</sub> ^D						
	V	Hz	KW	d/d	m³/h (max)	Pa (max)	kg
YB 1M-1T	230/380	50	0.37	2800	350	2500	20
YB 2M-2T	230/380	50	0.75	2800	400	3000	28
YB3M-3T	230/380	50	1.1	2800	450	4000	42
YB 4M-4T	230/380	50	1.5	2800	500	4500	47
YB 5M-5T	230/380	50	2.2	2800	600	5000	58
YB 6M-6T	230/380	50	3	2800	1000	7000	60
YB7T	380	50	4	2800	1200	8000	67
YB8T	380	50	5.5	2800	1300	9000	106
YB	380	50	7.5	2800	1500	10000	134

# RADIAL FANS

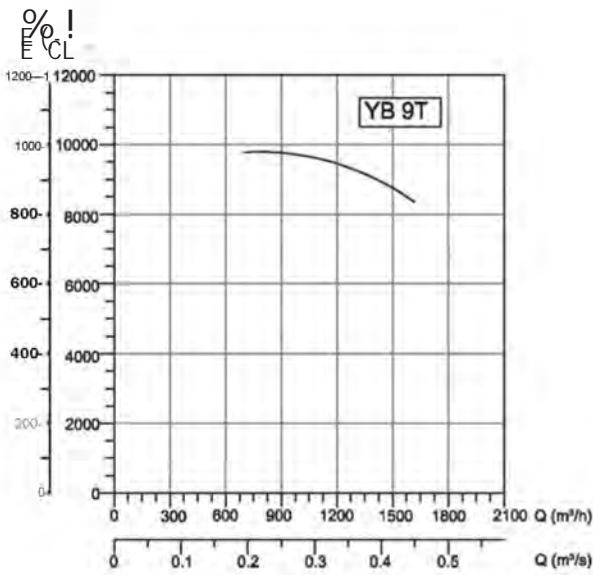
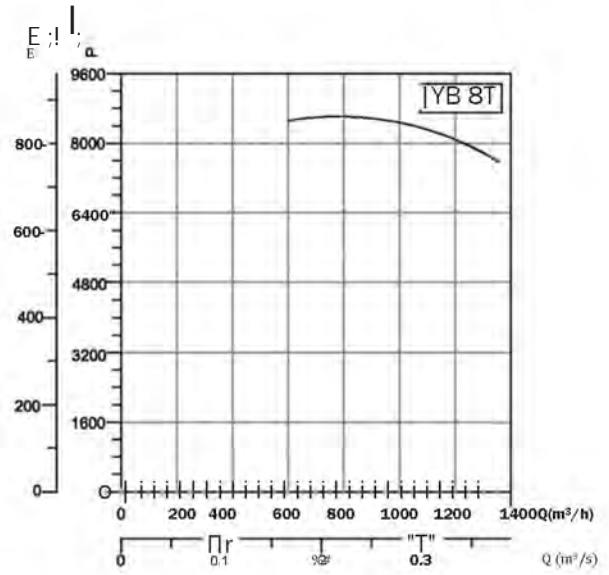
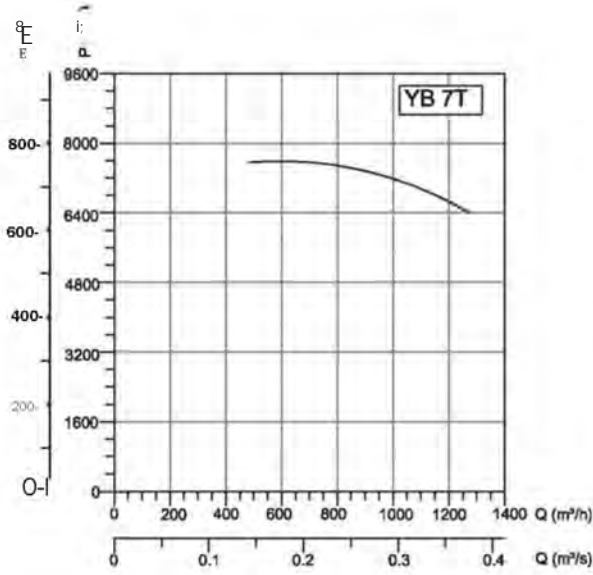
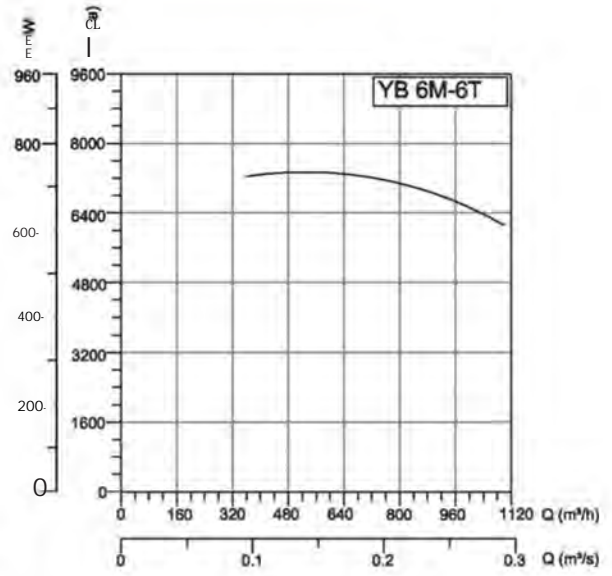
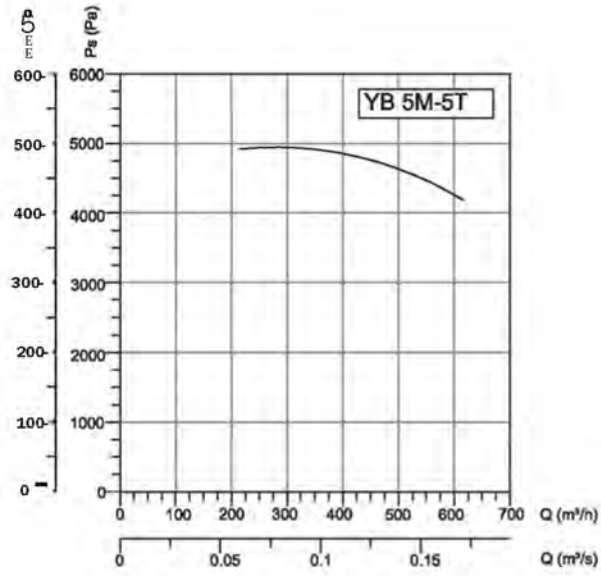

Accessories

BSC-F



# SUCTION - BLOWING DIRECTIONS

**LEFT**  
**A**  
)

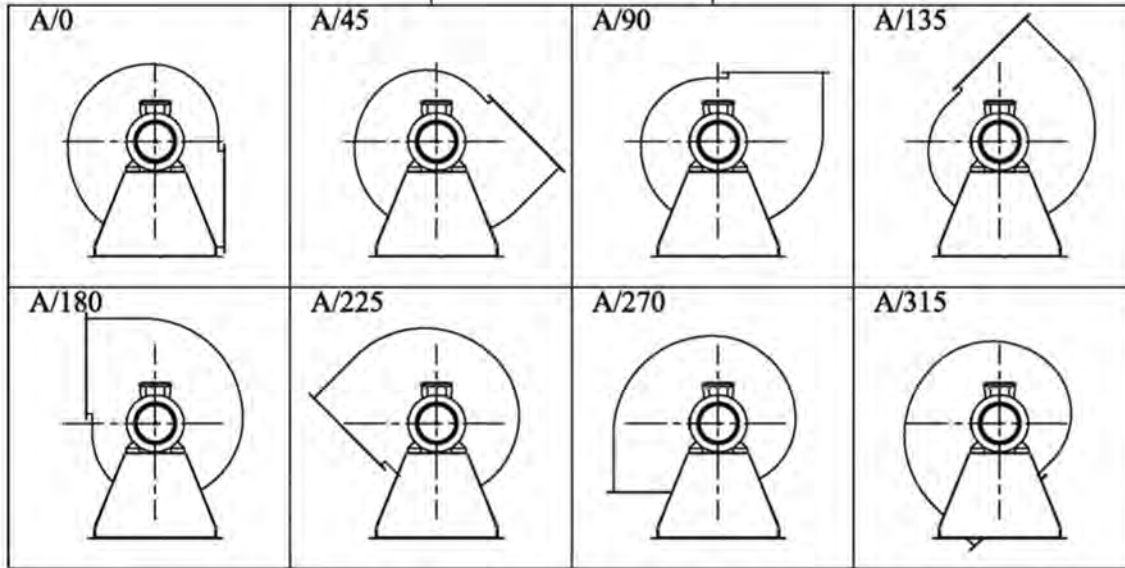

**RIGHT**  
**B**  
**C**

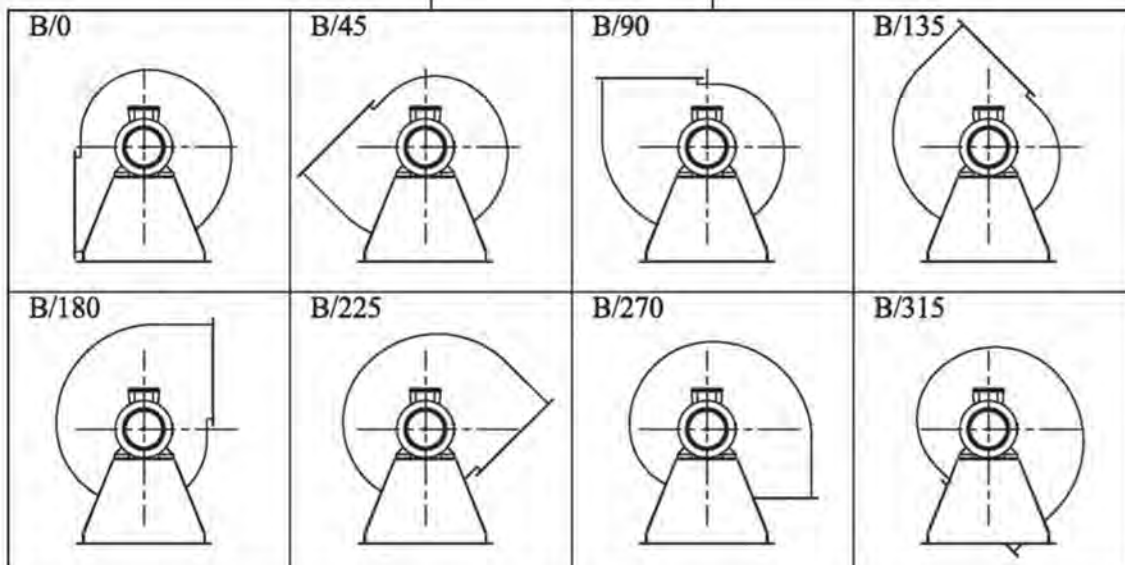

# PLASTIC FANS

EF

EC

EA

BPP

BH

... < r ^

# PLASTIC FANS

## EF

AC PLASTIC DOMESTIC FANS

Decorative



The front panel is thin and tight, so that it is mounted solid,  
Silent and strong against corrosion, Motor's life is long through  
environmental factors,

### Technical Drawings

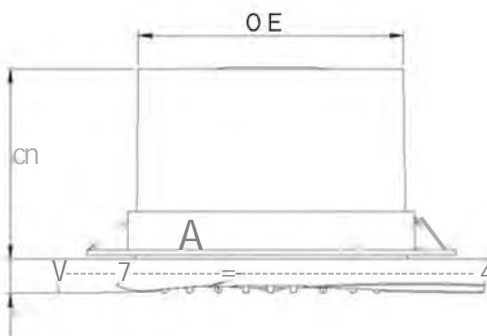
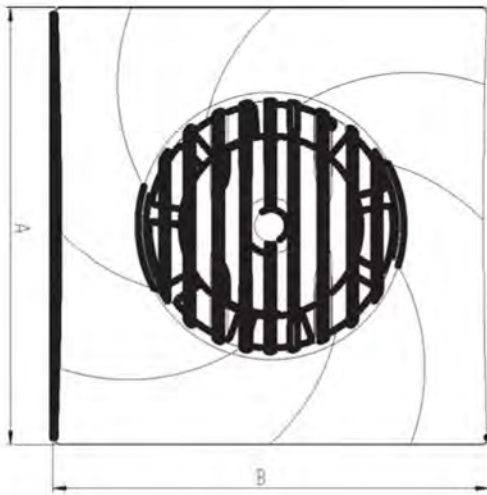

#### MATERIAL

- ABS plastic material, Impeller's design and dynamic balance provides a high air performance and silence,  
Thanks to it's special surface, never shine and change it's color,

#### INSULATION CLASS

- Class

#### DIRECTIVE

- EN 60335-1, EN 60335-2-80

#### SPEED CONTROL

- Speed can be adjusted using an optional controller,

#### APPLICATION AREAS

- Bathrooms, kitchens, meeting rooms, offices etc, areas where silence and strength against corrosion is asked,

TYPE	A			D	E
EF 1009	160	160	12	70	97,5
EF 1219	188	188	14	76	118
EF 1530	208	208	14	118	145

Dimensions are in (mm)

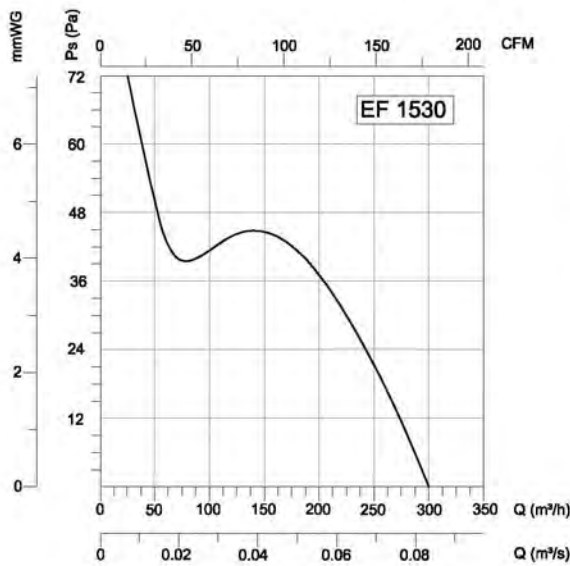
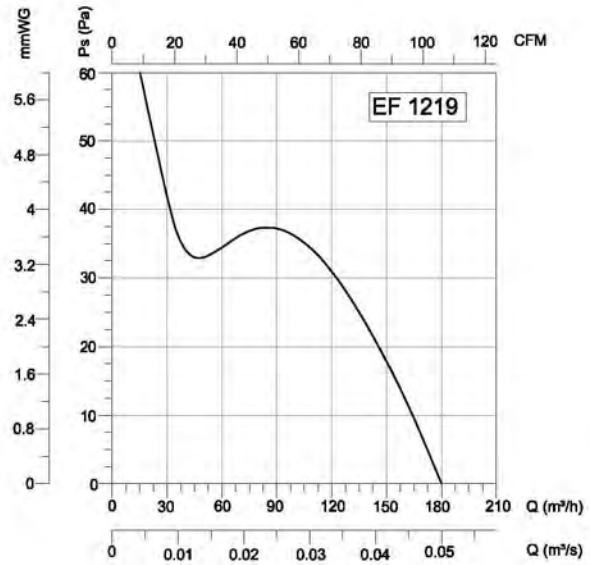
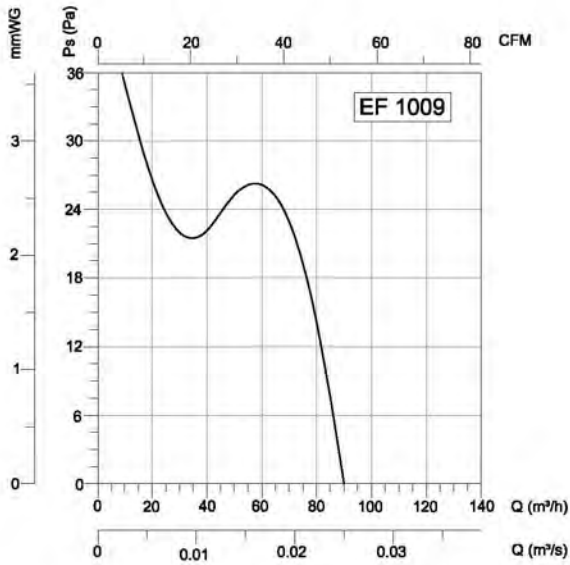

TYPE	VOLTAGE	FREQUENCY	POWER	CURRENT	SPEED	AIR FLOW	SOUND PRESSURE LEVEL	WEIGHT
	V	Hz	W	(A)	d/d	m³/h	dB(A)	kg
EF1009	230	50	14	0Δ	2600	90	47	0.5
EF1219	230	50	17	0Δ	2300	190	45	0.55
EF 1530	230	50	25	0Δ	2150	300	48	0.71

# PLASTIC FANS



# EA

## AC PLASTIC DOMESTIC FANS Standard

Safety with it's front wider panel. Silent and strong against corosion. Motor's life is long against the environmental factors.

### Technical Drawings

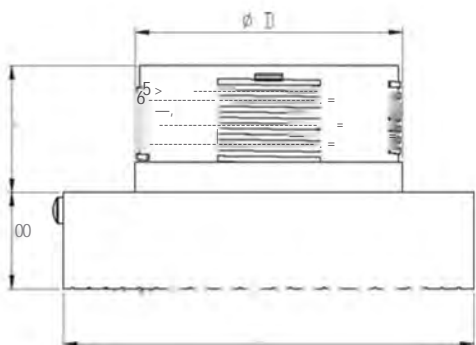
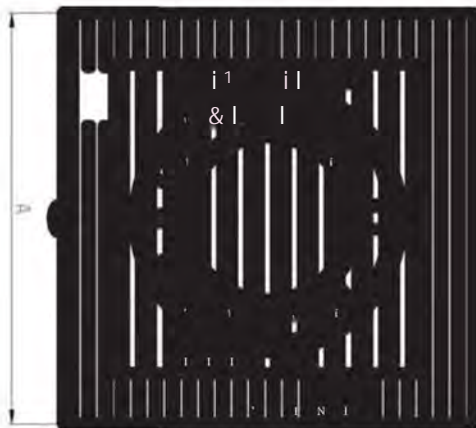

MATERIAL

: ABS plastic material. Impeller's design and dynamic balance provides a high air performance and silence. Thanks to it's special surface, never shine and change it's color. Protection against wet and oxidation.

INSULATION CLASS

: Class

DIRECTIVE

: EN 60335-1, EN 60335-2-80

SPEED CONTROL

: Speed can be adjusted using an optional controller.

APPLICATION AREAS

: Bathrooms, kitchens, meeting rooms, offices etc. areas where silence and strength against corrosion is asked.

TYPE	A	B	O	D	E	
EA 1010	149	35	54	97	149	
EA 1219	188	8	76	118	188	
EA1530	208	45	73	149	208	

Dimensions are in (mm)

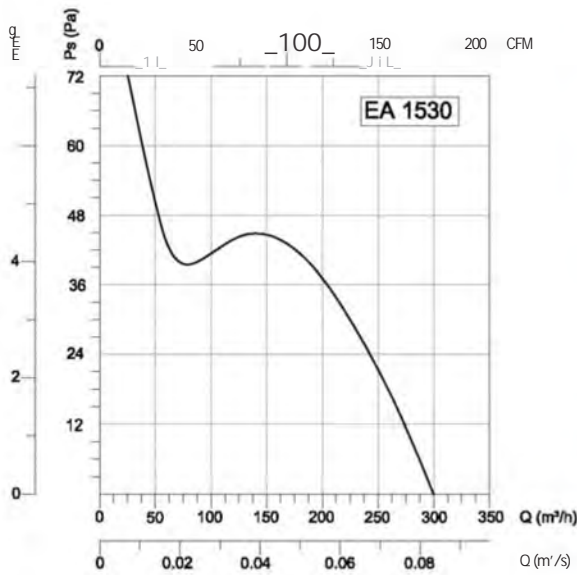
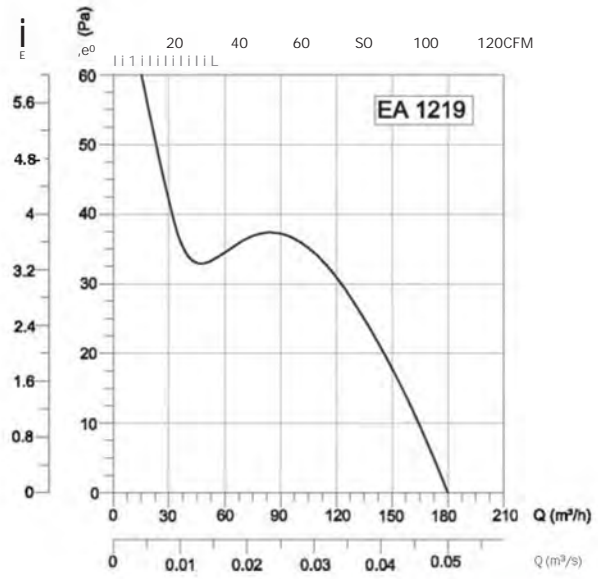
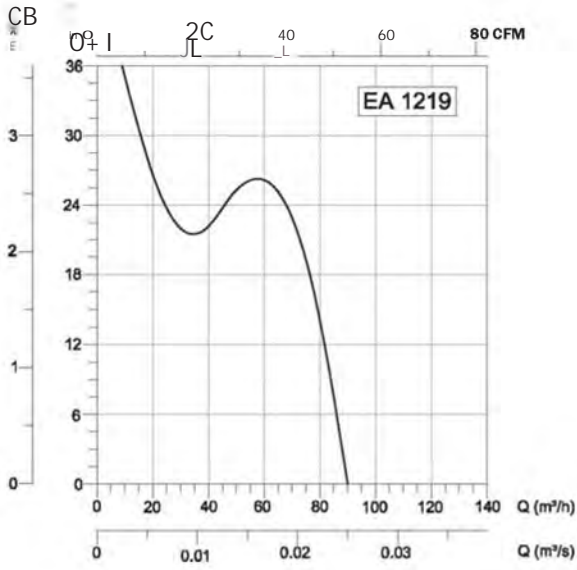

TYPE	VOLTAGE	FREQUENCY	LC5	CURRENT	SPEED	AIR FLOW	SOUND PRESSURE LEVEL	WEIGHT
	V	Hz	w	(A)	d/d	m³/h	dB(A)	kg
EA1C1C	23C	5C	15	C,1	26CC	1C5	45	C,52
EA1219	23C	5C	15	C,1	23CC	195	47	C,6
EA 153C	23C	5C	25	C,17	21CC	3CC	43	1,12



# PLASTIC FANS



## EC

### AC PLASTIC DOMESTIC FANS Automatic Shutter

Automatic shutter option. Shutter opens once the fan is in use, it close itself automatically once the fan switch off. Panel is thin and tight so that it is mounted solid. Silent and strong against corrosion. Motor's life is long against the environmental factors.

#### Technical Drawings

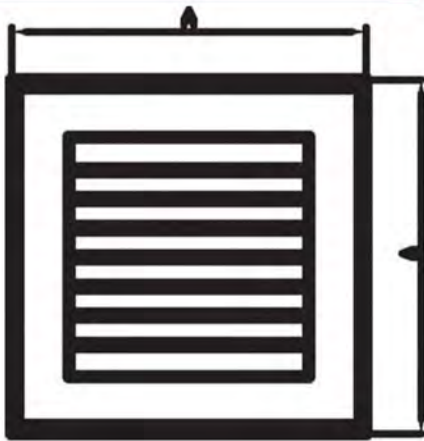

- MATERIAL** : ABS plastic material. Impeller's design and dynamic balance provides a high air performance and silence. Thanks to it's special surface, never shine and change it's color. Protection against wet and oxidation.
- INSULATION CLASS** : Class
- DIRECTIVE** : EN 60335-1, EN 60335-2-80
- SPEED CONTROL** : Speed can be adjusted using an optional controller.
- APPLICATION AREAS** : Bathrooms, kitchens, meeting rooms, offices etc. areas where silence and strength against corrosion is asked.

TYPE	A			D
EC 1010E	150	45	35	97
EC 1219E	170	55	44	118
EC 1530E	210	73	60	149

Dimensions are in (mm)

TYPE	9j V	>- z Ö LL. Hz	POWER W	CURRENT (A)	SPEED d/d	AIR FLOW m³/h	SOUND PRESSURE LEVEL dB(A)	WEIGHT kg
EC 1010E	230	50	20	0,1	2650	105	45	0.6
EC 1219E	230	50	21	0,12	2335	195	47	0.65
EC 1530E	230	50	30	0,17	1920	300	48	0.84

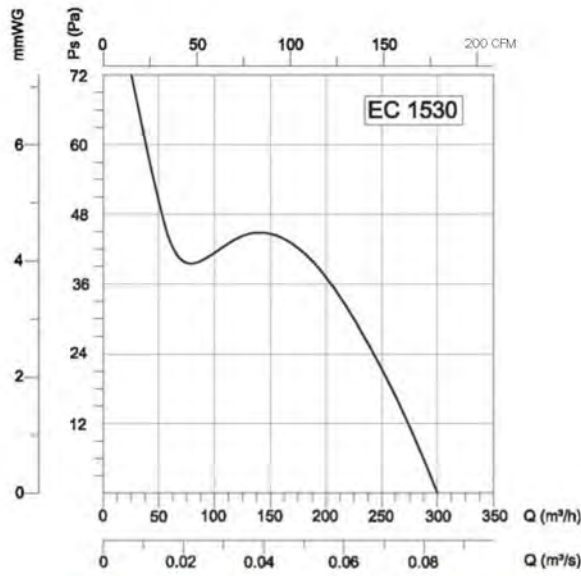
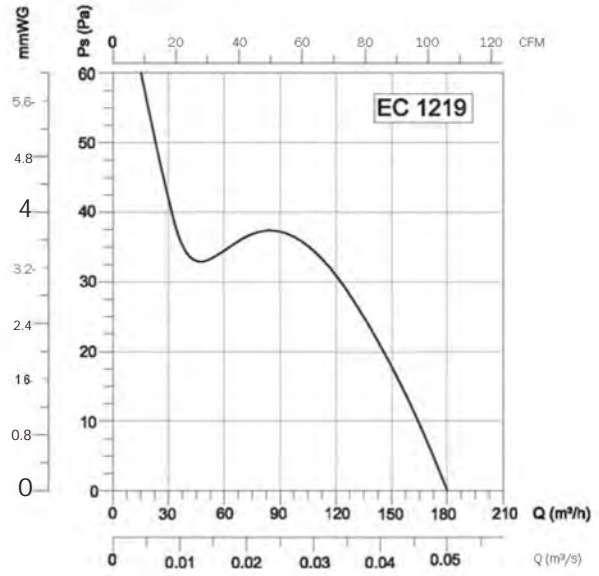
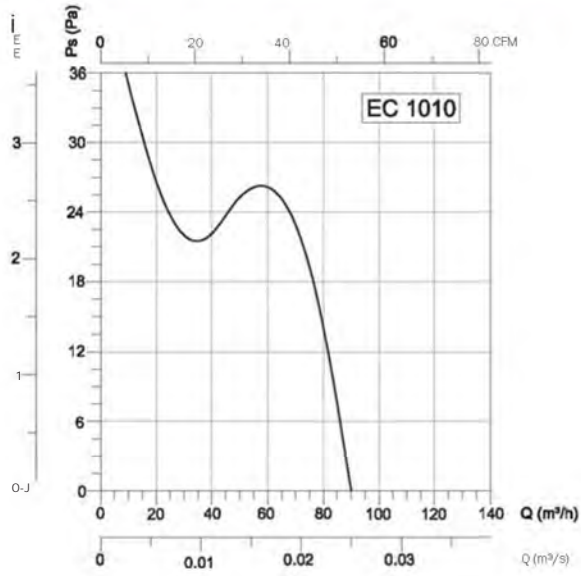

## PLASTIC FANS



# BPP

## AC REVERSIBLE WALL MOUNTED PLASTIC FANS

The unification of the grill and panel - both in a single composite structure, gives a slimmer body to the fan and a tight fit on installation. Airflow direction can be changed by switch cord.

### Technical Drawings

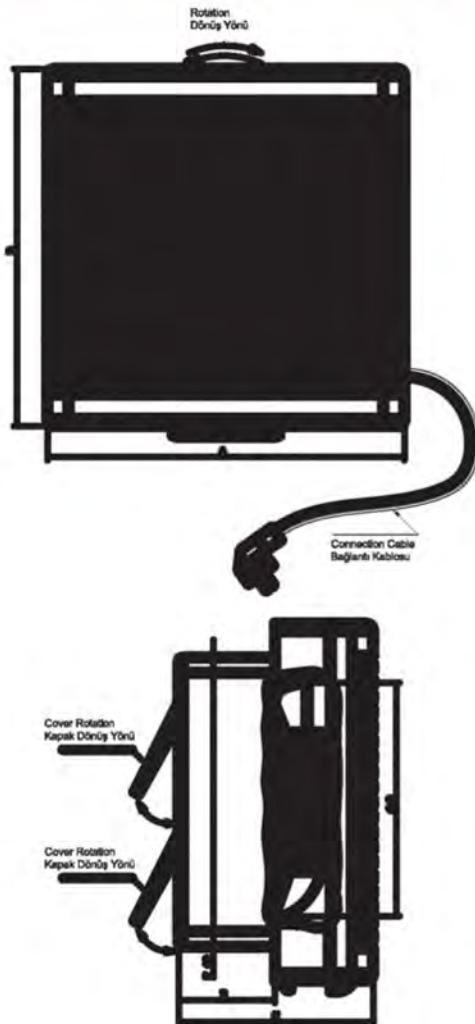

#### MATERIAL

: ABS plastic material, Impeller's design and dynamic balance provides a high air performance. Thanks to its special surface, never shine and change color,

#### INSULATION CLASS

: Class

#### DIRECTIVE

: EN 6C335-1, EN 6C335-2-8C

#### SPEED CONTROL

: Speed can be adjusted using an optional controller.

#### APPLICATION AREAS

: Bathrooms, kitchens, meeting rooms, offices etc. Used in Areas, where silence desired or strength needed against corrosion,

### Accessories



### BSC

TYPE	A	B	C	D	e	F
BPP 15	235	235	16C	65	13C	19C
BPP 2C	29C	29C	20C	65	14C	24C
BPP 25	34C	34C	25C	7C	145	29C
BPP3C	395	395	30C	8C	155	335

Dimensions are in (mm)

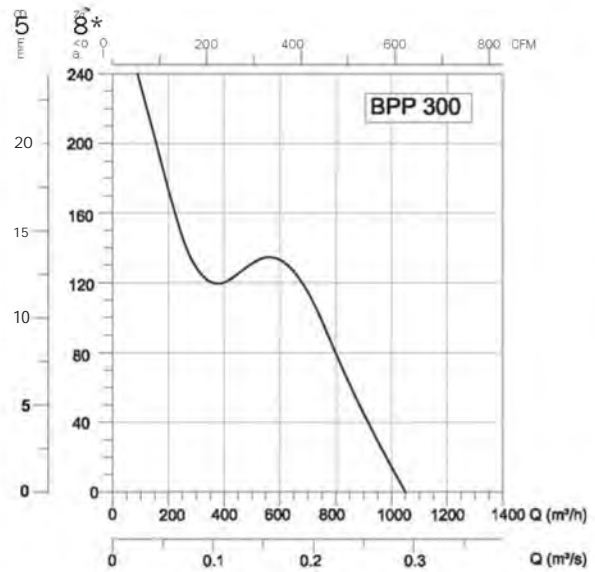
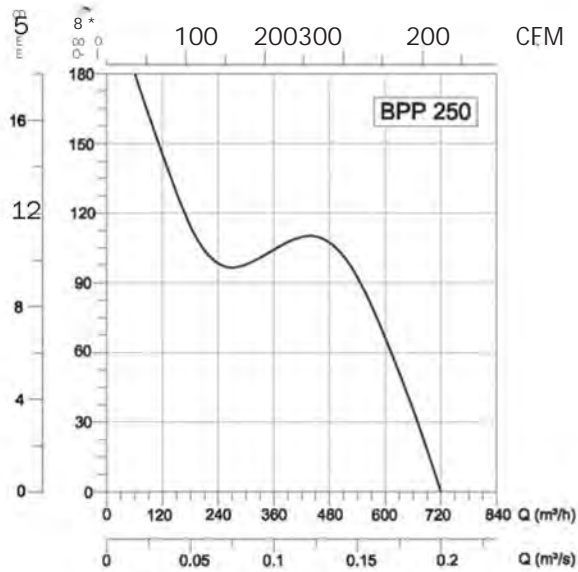
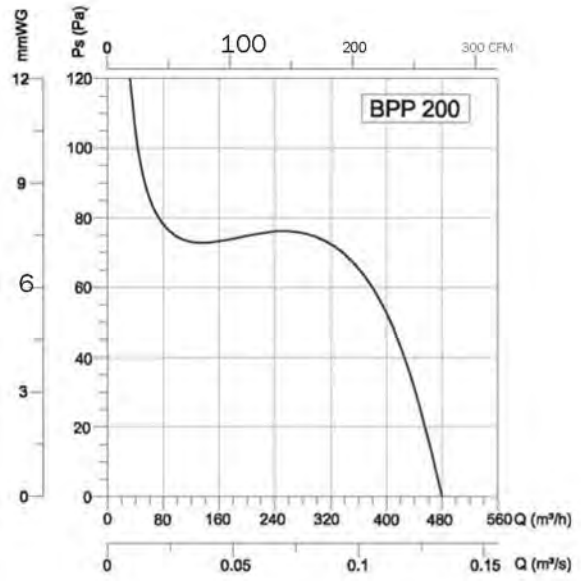
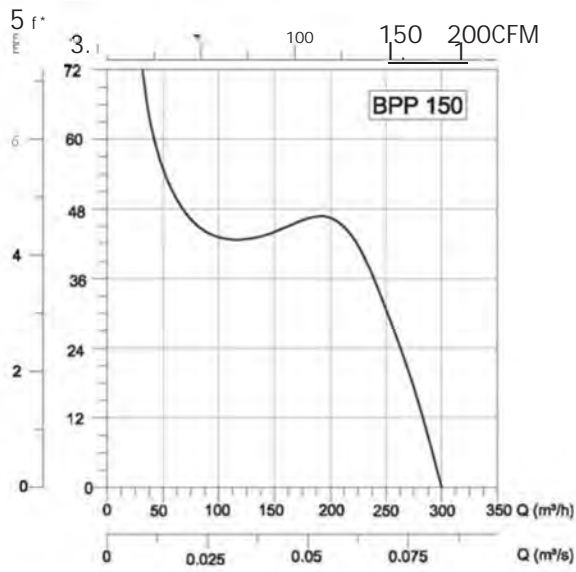

TYPE	VOLTAGE	FREQUENCY	POWER	CURRENT	SPEED	AIR FLOW	SOUND PRESSURE LEVEL	WEIGHT
	V	Hz	W	(A)	d/d	m³/h	dB(A)	kg
BPP15	230	50	25	0,14	1300	300	40	1.8
BPP 20	230	50	30	0,16	1250	500	41	2.6
BPP 25	230	50	35	0,19	1200	735	43	2.8
BPP 30	230	50	45	0,25	1100	1100	44	3.2



# VENTILATORS

BSV/BSV-D

# BSV/BSV-D

AC INDUSTRIAL VENTILATORS

Wall Mounted



Automatic turning is available horizontally and manual turning is available vertically. Wall mounted model is suitable for mounting to the wall easily. 3 different speed key.

**MATERIAL**

- Metal Grid Body. Blade is made of fiberglass mixed plastic.

**ROTATION**

- CW (Clockwise)

**INSULATION CLASS**

- Class F

**DIRECTIVE**

- EN 60335-1, EN 60335-2-80

**APPLICATION AREAS**

- Green Houses, Paint cabinet, Textile workshops, restaurants, production facilities etc.

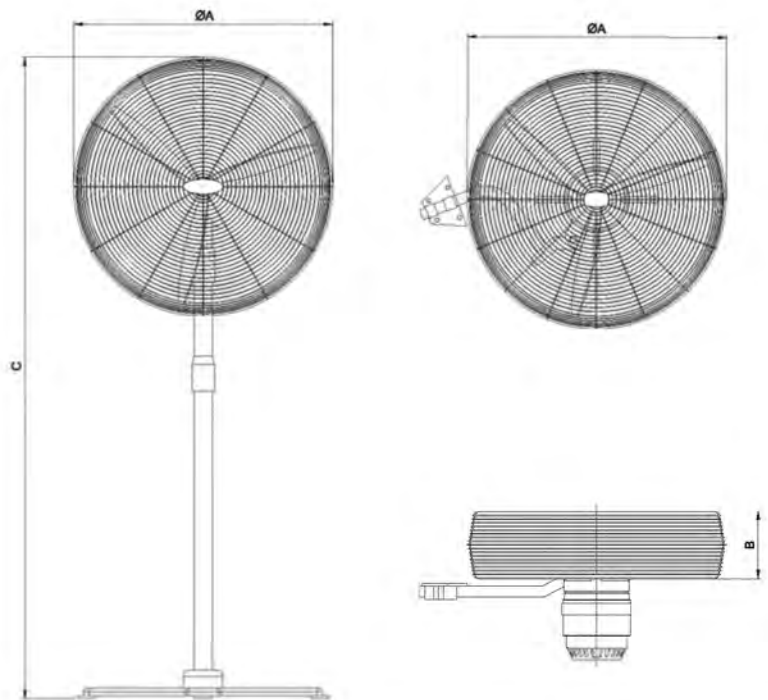

TYPE	A		
BSV 500	500	120	1900
BSV 600	600	120	1900
BSV 750	720	120	1950
BSV-D 600	600	120	
BSV-D 750	750	120	

Dimensions are in (mm)

TYPE	VOLTAGE	FREQUENCY	POWER	SPEED	5 LEVEL 5	5 LEVEL 5
	V	Hz	W	d/d	m/h	kg
BSV 500	230	50	120	1400	7000	19
BSV 600	230	50	150	1400	11000	24
BSV 750	230	50	350	1400	17400	27
BSV-D 500	230	50	120	1400	7000	19
BSV-D 600	230	50	150	1400	11000	24
BSV-D 750	230	50	350	1400	17400	27



DUCT FANS

ROOF FANS

AXIAL FANS

RADIAL FANS

PLASTIC FANS

**VENTILATORS**

SMOKE EXHAUST SYSTEMS

ACCESSORIES





# SMOKE AND HEAT EXHAUST VENTILATION SYSTEMS

## ARMO-J

® Ji 1  
F400-120 F300-120

Axial Jet Fans

Jet Fans are high temperature resistant fans which direct the toxic gases to exhaust points by means of creating jet flow, thrust and momentum thanks to having long casing. Thereby this keeps emergency exits and escaping routes free of smoke. These devices are mounted via mountingfeets in conformity with the structural beams, sprinkler system units and instailment units distribution.

### Technical Descriptions

#### General Specifications

- Tested and certified in accordance with EN 12101-3 and CE.
- Ensured non - stop operation at eievated temperatures of 300° and 400° for 2 hours respectively.
- Different fan dimensions as 315, 355 and 400 mm respectively.
- Special deflector design to avoid architectural disadvantages
- Esthetic appearance

#### Rotor Specifications

- High temperature resistant aluminum alloy casting blades and hub.
- Rotors can operate uni - directional and fully - reversible. Blades are specially designed for each direction type and have airfoii structure which has high aerodynamic performances.
- Fully - reversible blades can provide same thrusts for each type of directions.
- The fan wheel is dynamically balanced in accordance with ISO 1940.
- The hub is specially designed.

#### Casing Specifications

- All casings are sheet steel with a corrosion resistant hot dipped galvanized finish.
- In addition to standard long - cased fans, the short - cased version is also available for limited installation spaces.
- The isolation material is mineral wool which is much more health - friendly than rock wool.

#### Motor Specifications

- 2 and 4 pole motors available
- IP 55 protection class
- Class - H insulation

#### Inlet Cone

- The inlet cone is specially designed to provide considerable benefit to aerodynamic performance and decrease sound levels.

#### Stators

- Stators are specially designed to provide considerable benefit to aerodynamic performance and decrease sound levels due to straight the fluid and convert its kinetic energy effects to pressure.

#### Inlet Nose

- The inlet cone is specially designed to provide considerable benefit to aerodynamic performance and decrease sound levels due to provide a smooth passing of air from backward of the fan to blades and avoid the back flows and separation near the hub.

#### Easy to Maintain

We have 2 types of fan in terms of maintenance.

- 3 part model: Jet Fan is consisting of 2 stationary silencers and a mobile part which can move downward the device via slide way system. Thanks to this system, you can maintain the jet fan easily avoiding the architectural handicaps. The samples are shown as below.
- 2 part model ("Pul - Spiit Model"): Jet Fan is consisting of 1 mobile silencer which can disassemble from stationary silencer which gives easy maintenance.

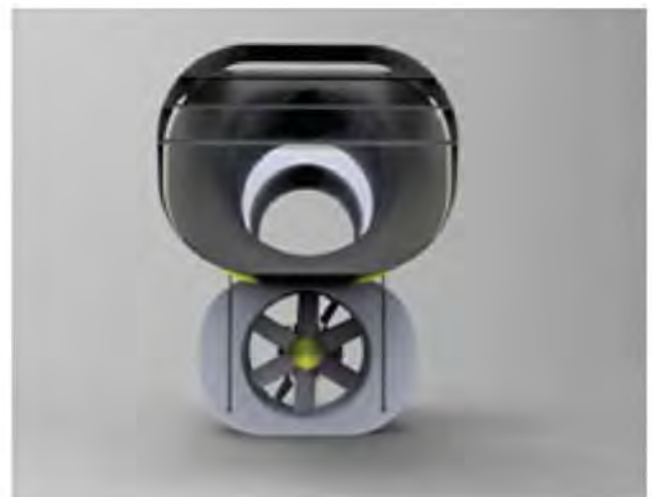

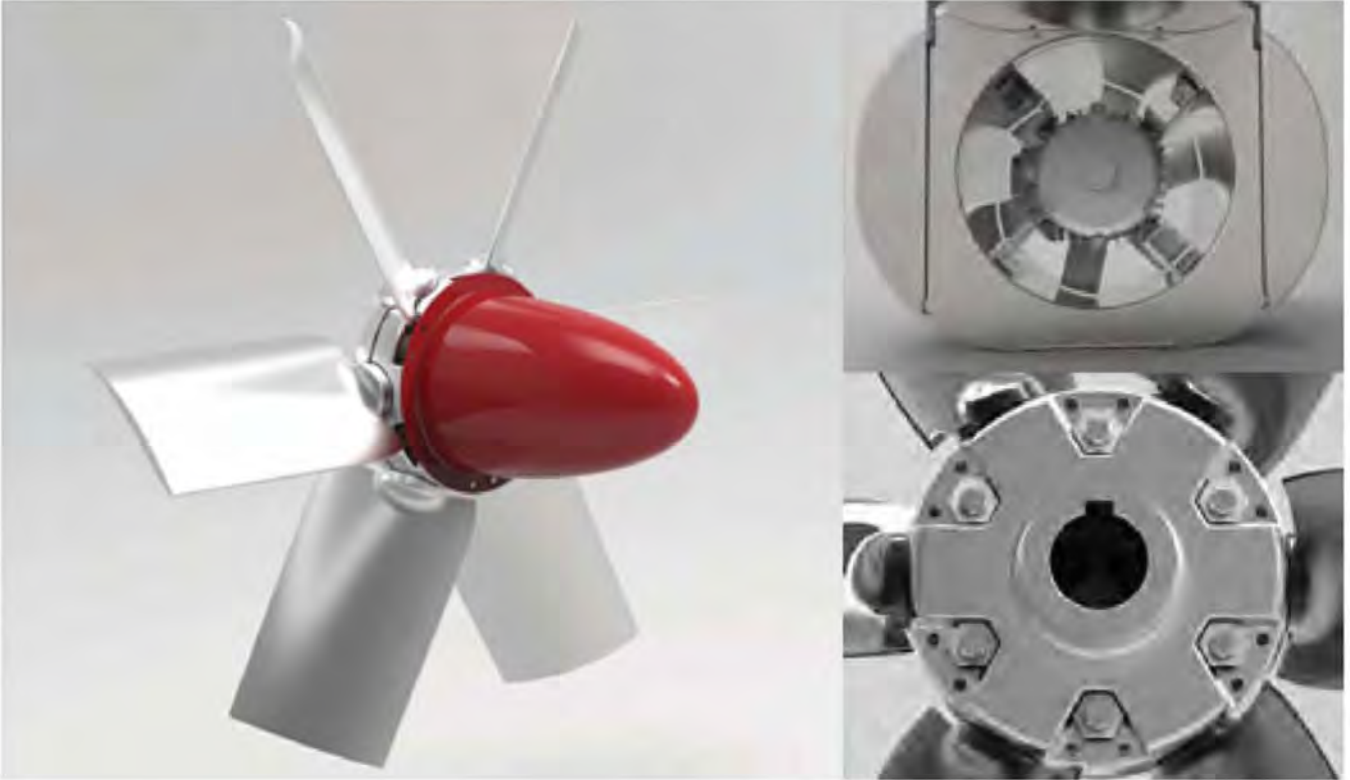

DUCT FANS

ROOF FANS

AXIAL FANS

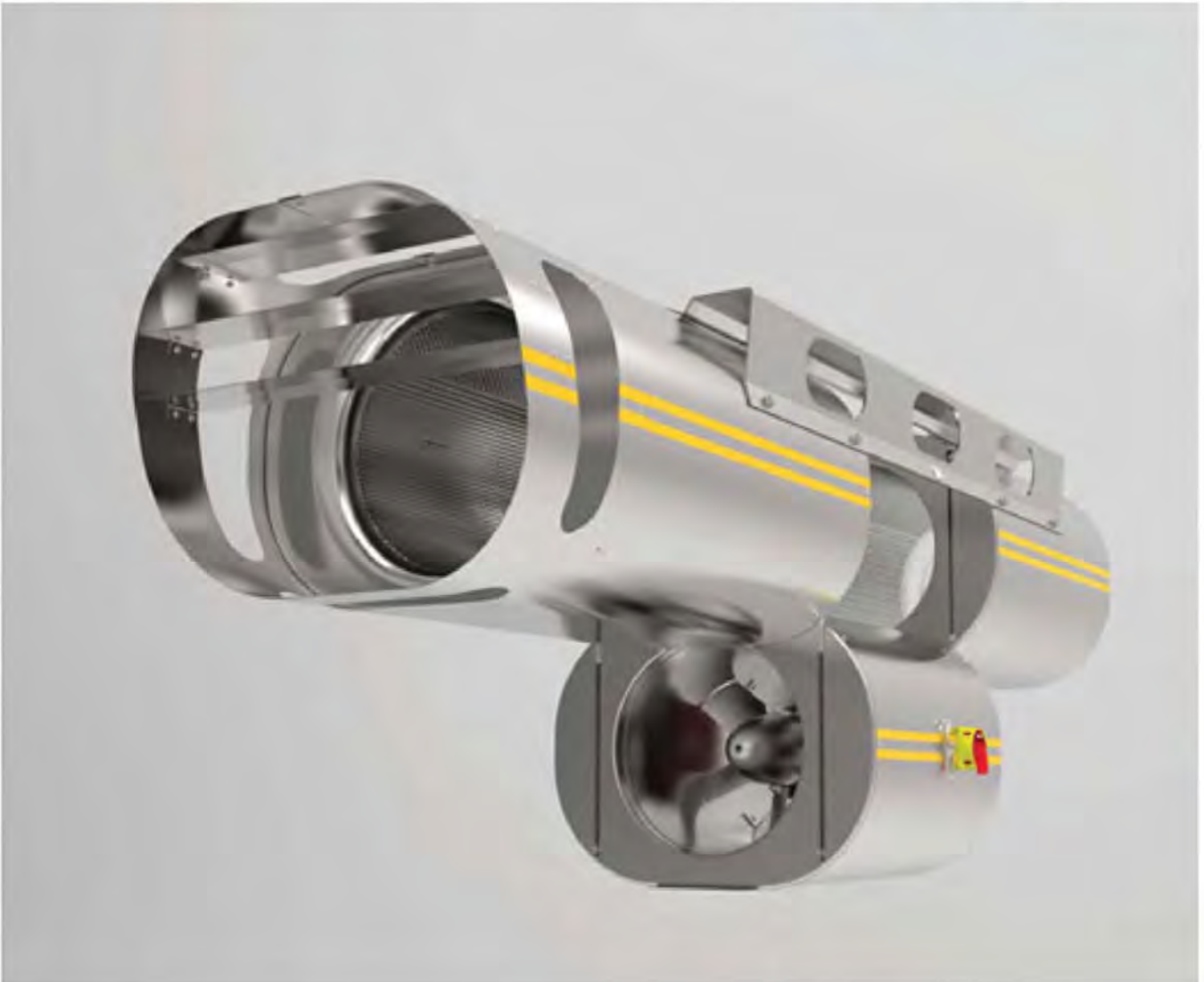

RADIAL FANS

PLASTIC FANS

VENTILATORS

SMOKE EXHAUST SYSTEMS

ACCESSORIES

# SMOKE AND HEAT EXHAUST VENTILATION SYSTEMS

## UNI-DIRECTIONAL JET FAN

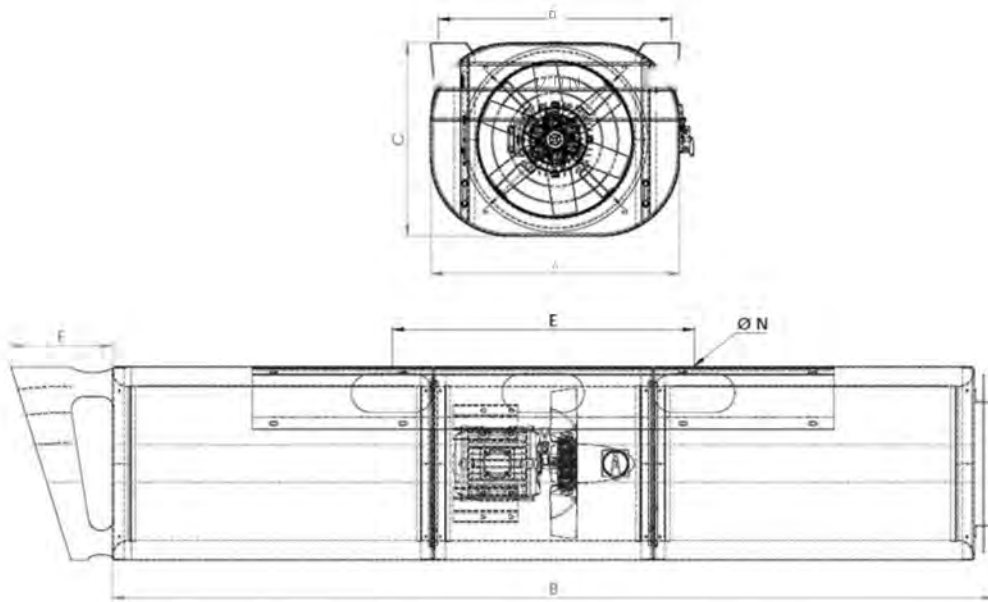

ARMO/3UL	A			D	E	F	ØN
0315	532	1788	402	495	700	245	M12
0355	579	2047	450	540	700	245	M12
0400	622	2292	492	586	700	245	M12

## REVERSIBLE JET FAN

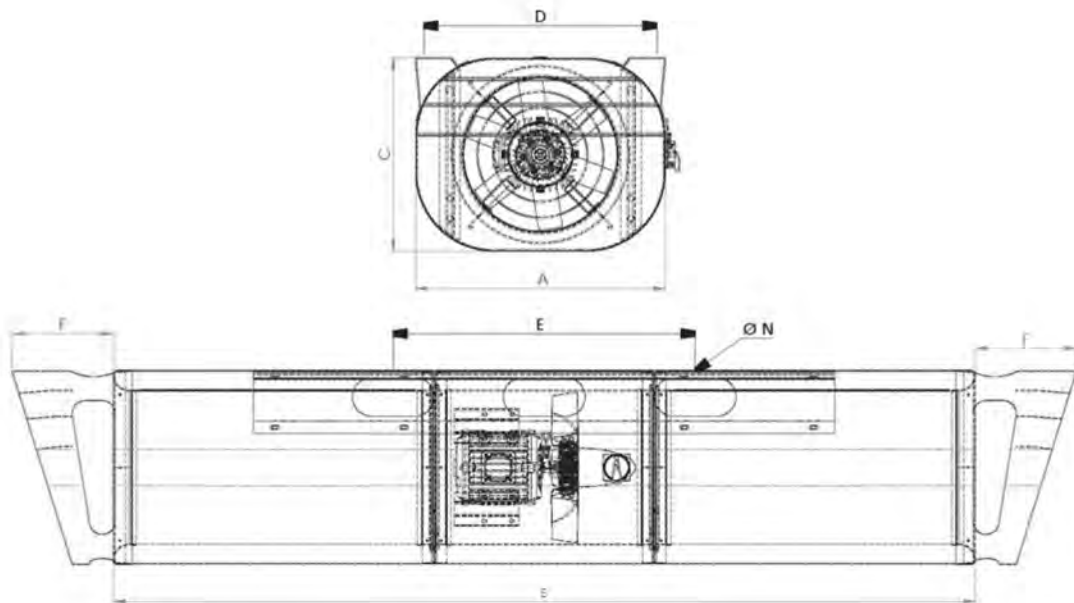

ARMO/3RL	A			D	E	F	ØN
0315	532	1745	402	495	700	245	M12
0355	579	2000	450	540	700	245	M12
0400	622	2250	492	586	700	245	M12

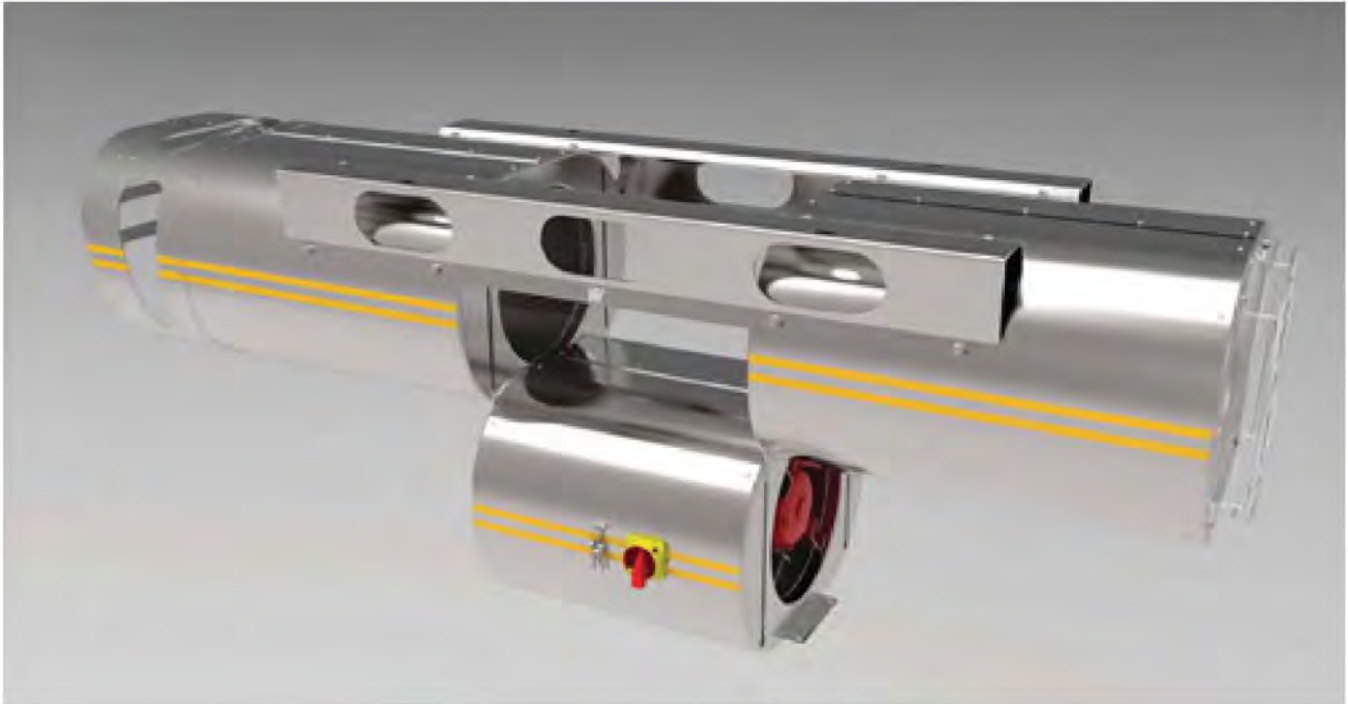

TYPE	THRUST	AIR VOLUME	MOTOR RATED POWER	MOTOR RATED CURRENT	SPEED	SOUND PRESSURE LEVEL AT 3m	WEIGHT
	(N)	m <sup>3</sup> /s	kW	(A)	rpm	LpAdB(A)	kg
ARMO-J315/ UL3	44/11	1,67/0,83 1,1/0,25		2,2/0,55 2810/1390		66/49	91
ARMO-J355/ UL3	59/14	2,22/1,11 1,5/0,37		3,4/0,8 2900/1435		70/52	98
ARMO-J400/ UL3	86/21	3,02/1,51 2,5/0,5		5,1/1,3 2845/1420		72/53	105
ARMO-J315/ UR3	36/9	1,5/0,75 1,1/0,25		2,2/0,55 2810/1390		62/45	93
ARMO-J355/ UR3	54/13	2,11/1,05 1,5/0,37		3,4/0,8 2900/1435		66/48	100
ARMO-J400/ UR3	77/19	2,85/1,42 2,5/0,5		5,1/1,3 2845/1420		68/49	107



# SMOKE AND HEAT EXHAUST VENTILATION SYSTEMS



## ARMO-A



Smoke and Heat Exhaust Fans

Smoke and Heat Exhaust Fans (SHEF) provides to evacuate the toxic gases which have been gained momentum by the Jet Fans, from car park to atmosphere. SHEF are the same high temperature resistant values as Jet Fans. SHEF are mounted as vertical or horizontal according to characteristics of structure.

### Technical Descriptions



#### General Specifications

- Tested and certified in accordance with EN 12101 - 3 and CE.
- Ensured non - stop operation at elevated temperatures of 300° and 400° 2 hours respectively.
- Different fan dimensions from 400 to 1250 mm.

#### Rotor Specifications

- High temperature resistant aluminium alloy casting blades and hub.
- Rotors can operate uni - directional and fully - reversible. Blades are specially designed for each direction type and have airfoil structure which has high aerodynamic performances.
- Fully - reversible blades can provide same thrusts for each type of directions.
- Pitch angle is adjustable thus different pressures and flow rates can be provided for the requirements.
- The fan wheel is dynamically balanced in accordance with ISO 1940.
- The hub is specially designed.

#### Casing Specifications

- All casings are sheet steel with a corrosion resistant hot dipped galvanized finish.
- In addition to standard long - cased fans, the short - cased version is also available for limited installation spaces.

#### Motor Specifications

- 2, 4 and 6 pole motors available
- IP 55 protection class
- Class - H insulation
- All electrical motors approved for "Running Continuously (S1)" or "Emergency Operation (S2)".

#### Easy to Maintain

- On Request: Long casing fans with inspection hatch to ease the maintenance.

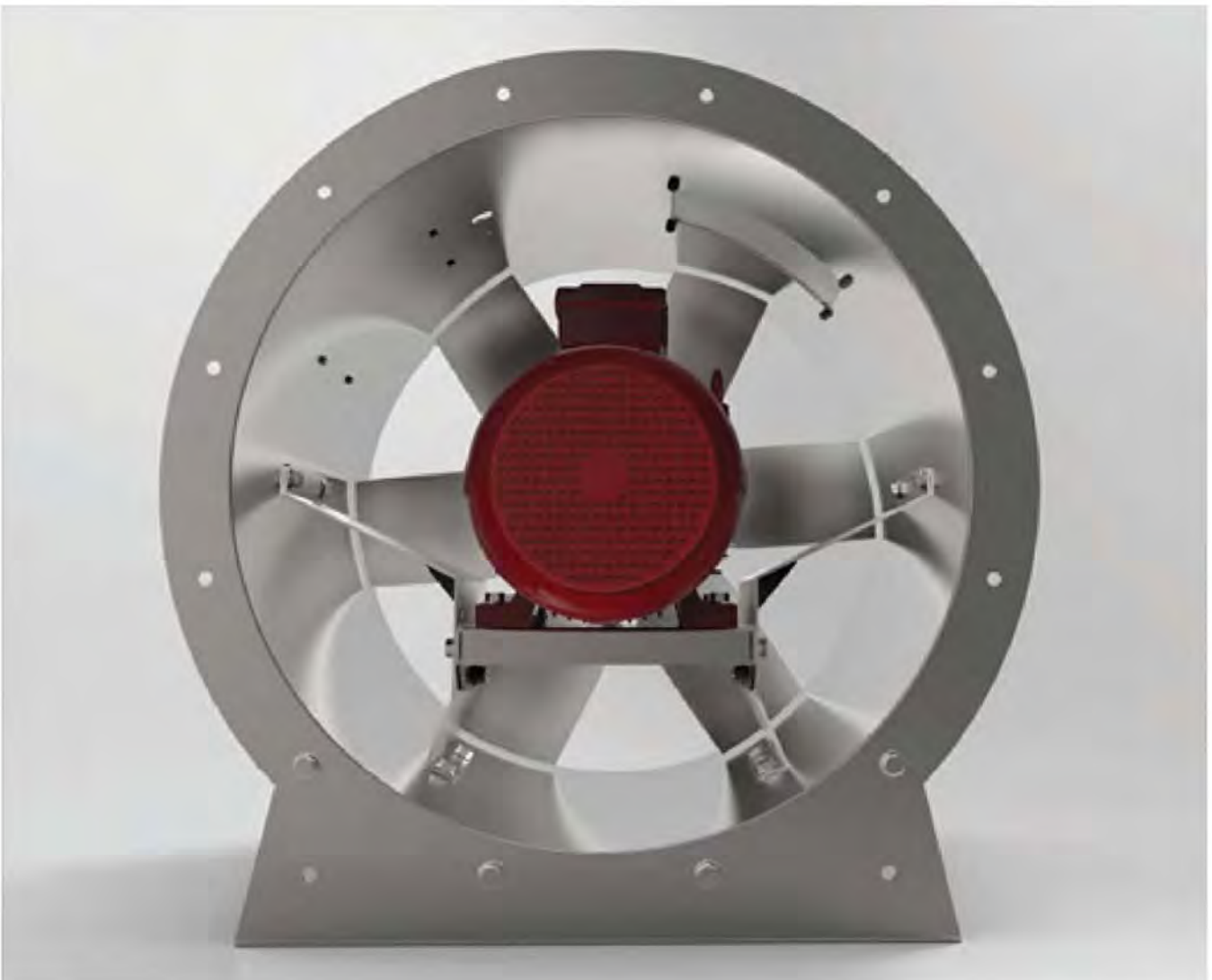

DUCT FANS

ROOF FANS

AXIAL FANS

RADIAL FANS

PLASTIC FANS

VENTILATORS

SMOKE EXHAUST SYSTEMS

ACCESSORIES

# SMOKE AND HEAT EXHAUST VENTILATION SYSTEMS

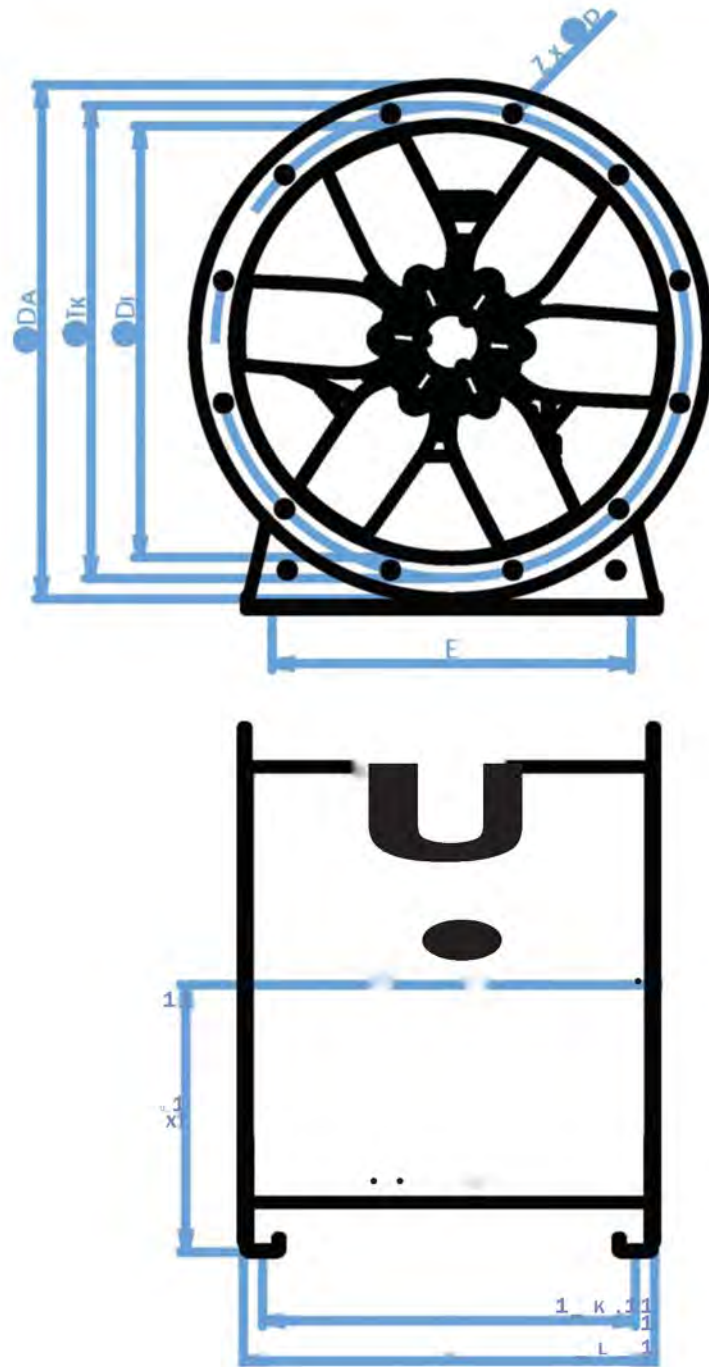

TYPE	ODi	ODa	OTk	ZxOd	L	Hf		E
ARMO-A400-UL	400	500	450	8x012	450	225	400	320
ARMO-A450-UL	450	550	500	8x012	450	250	400	370
ARMO-A500-UL	500	620	560	12x012	550	290	500	410
ARMO-A560-UL	560	680	620	12x012	550	350	500	460
ARMO-A630-UL	630	750	690	12x012	600	400	544	525
ARMO-A710-UL	710	830	770	16x012	650	425	590	560
ARMO-A800-UL	800	920	860	16x012	700	485	624	630
ARMO-A900-UL	900	1040	970	16x015	800	525	720	730
ARMO-A1000-UL	1000	1140	1070	16x015	850	595	772	830
ARMO-A1120-UL	1120	1260	1190	20x015	950	650	860	850
ARMO-A1250-UL	1250	1390	1320	20x015	1050	720	950	900

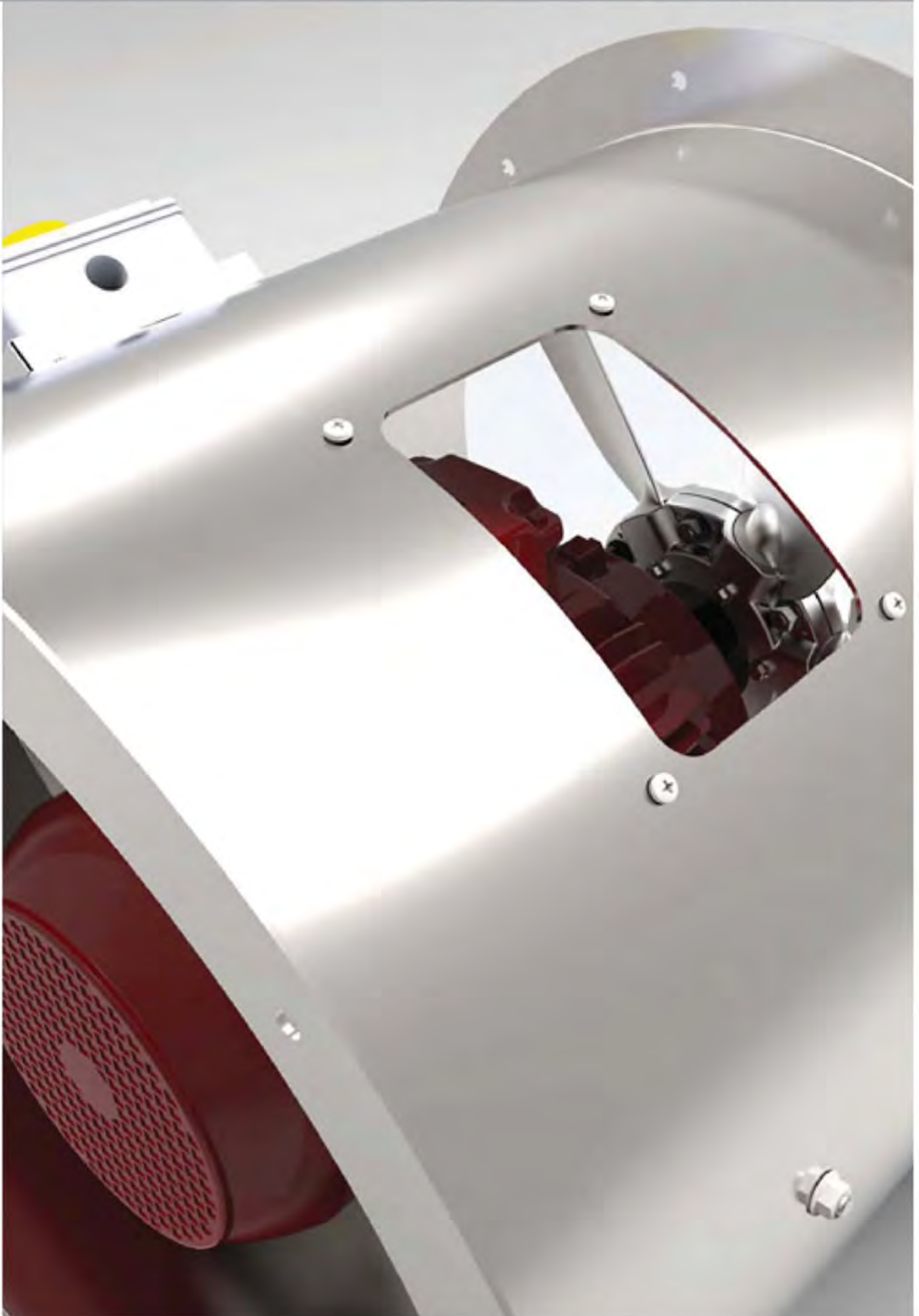

DUCT FANS

ROOF FANS

AXIAL FANS

RADIAL FANS

PLASTIC FANS

VENTILATORS

**SMOKE EXHAUST SYSTEMS**

ACCESSORIES



# SMOKE AND HEAT EXHAUST VENT ILAT I ON SYSTEMS

\*RMI>A400/b/7A

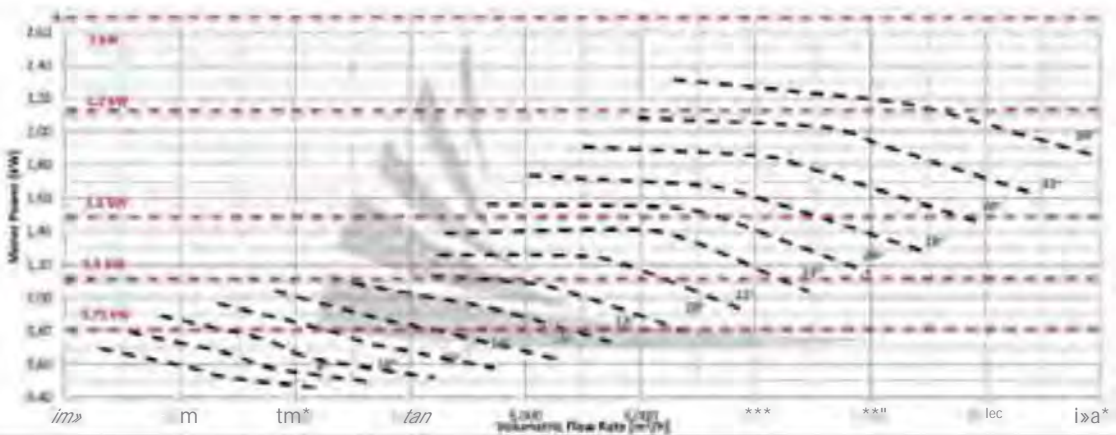
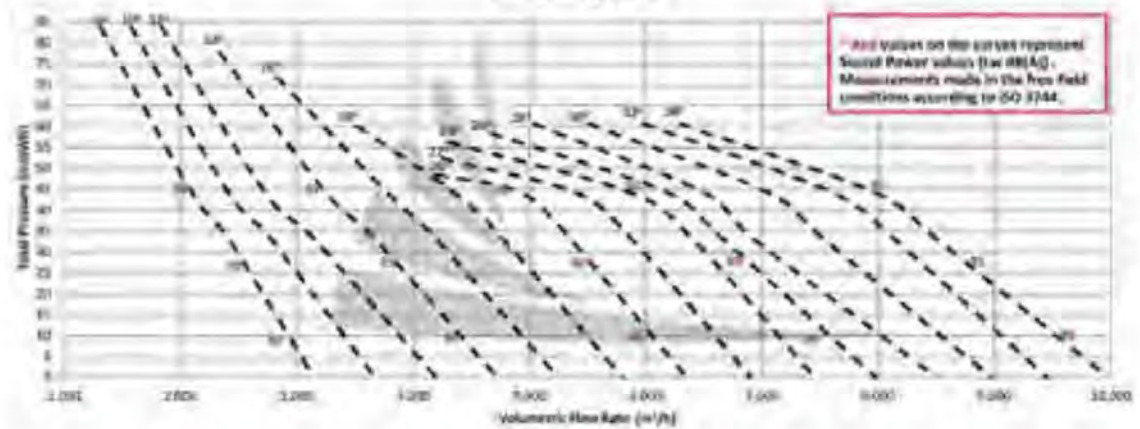

MWMM/I/J\*

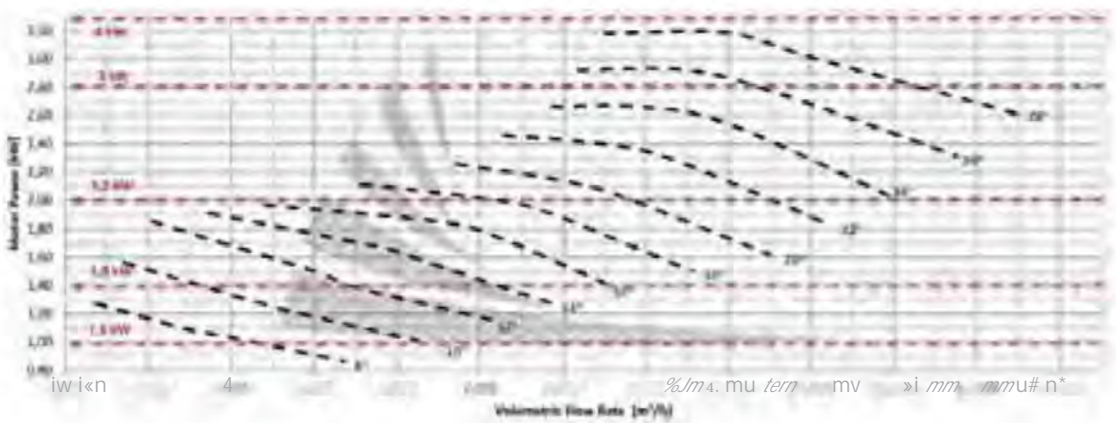
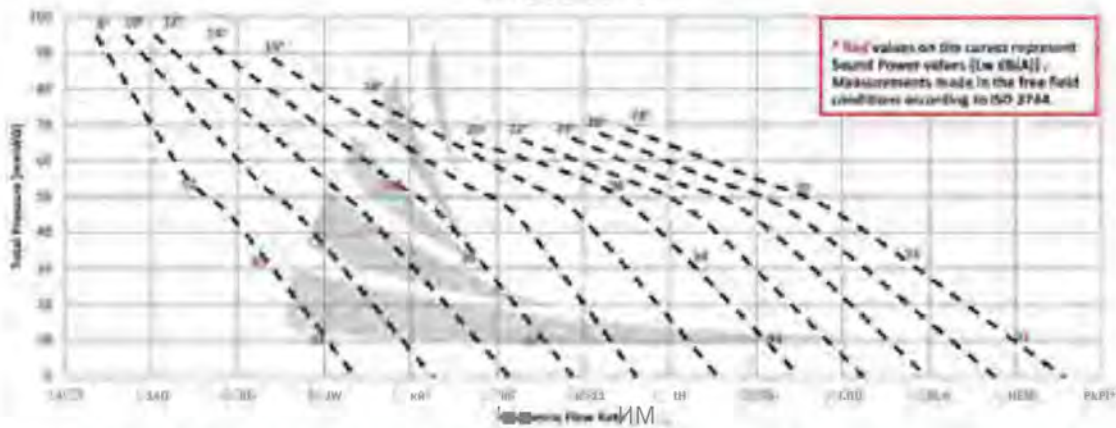

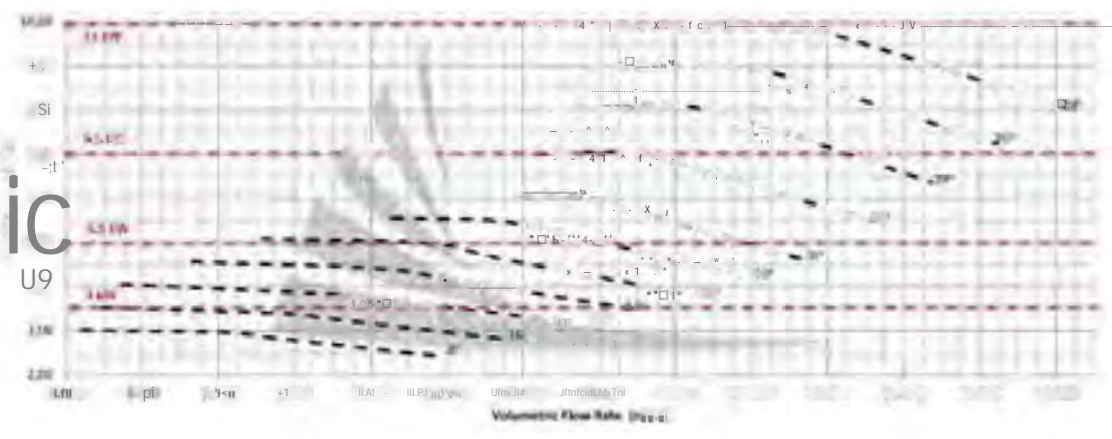
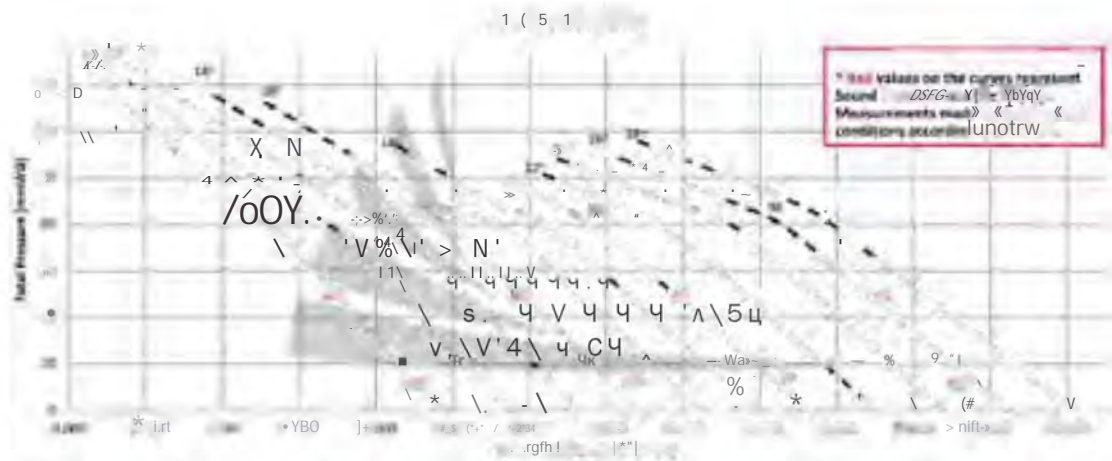
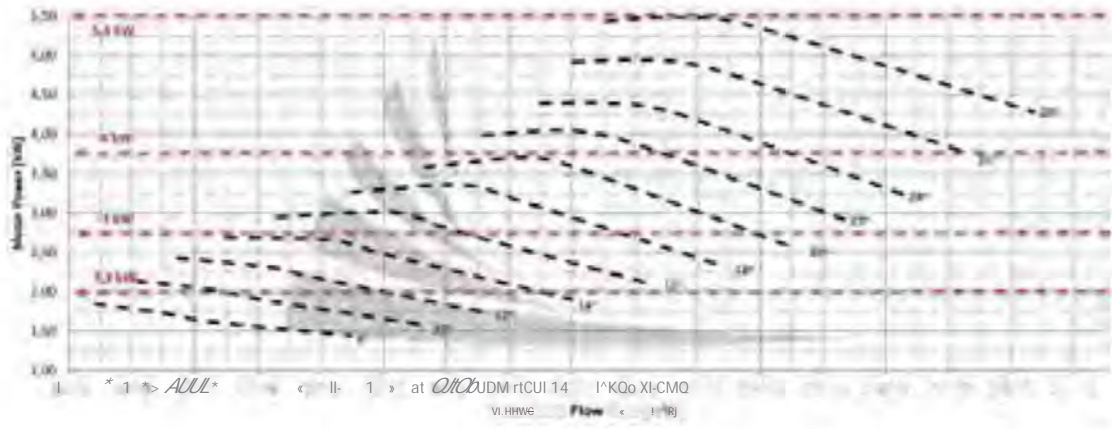
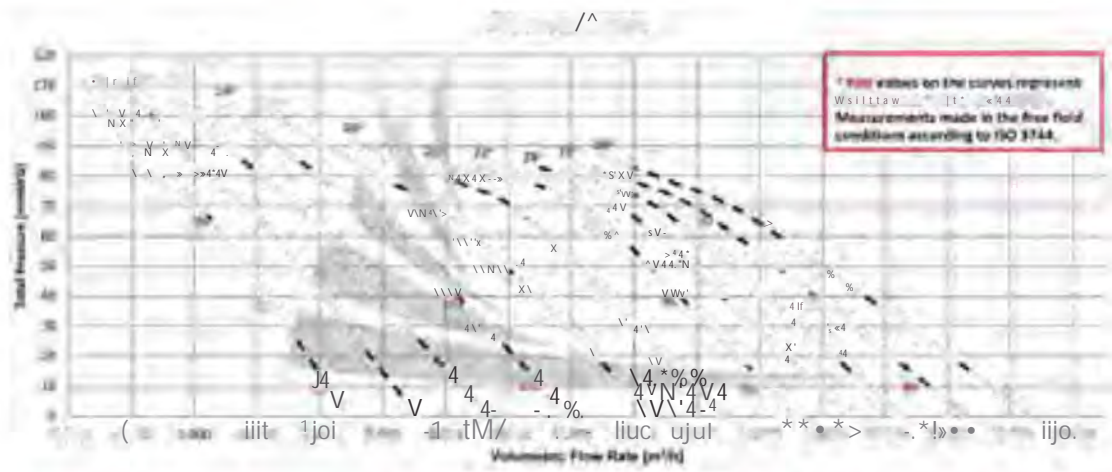

ic  
U9

# SMOKE AND HEAT EXHAUST VENTILATION SYSTEMS

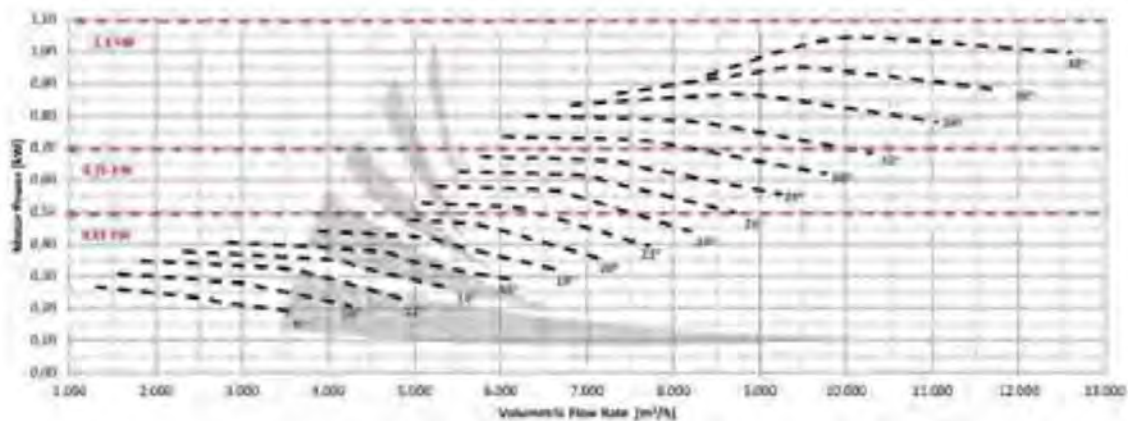
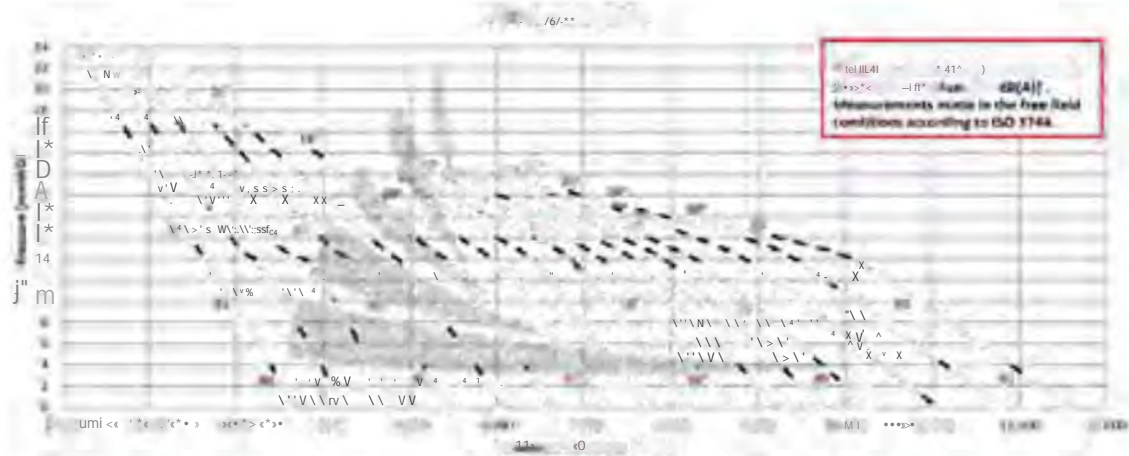
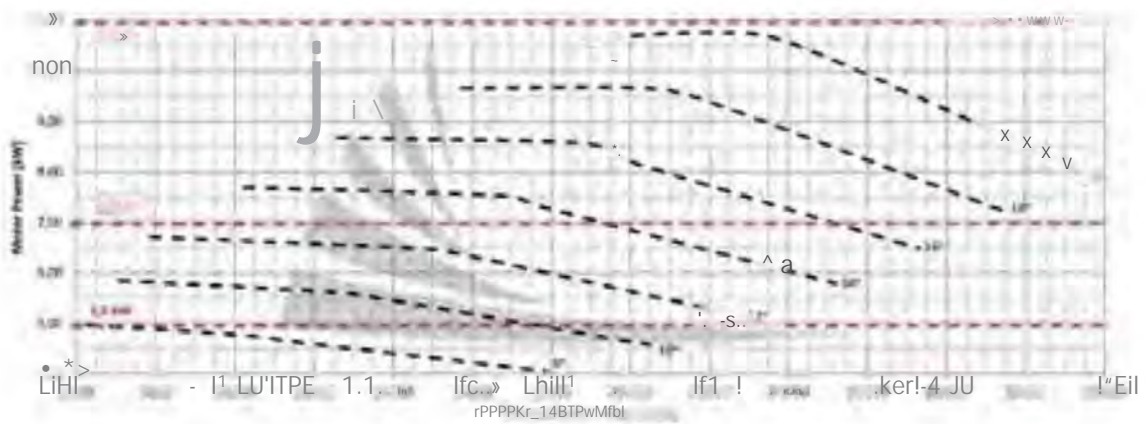
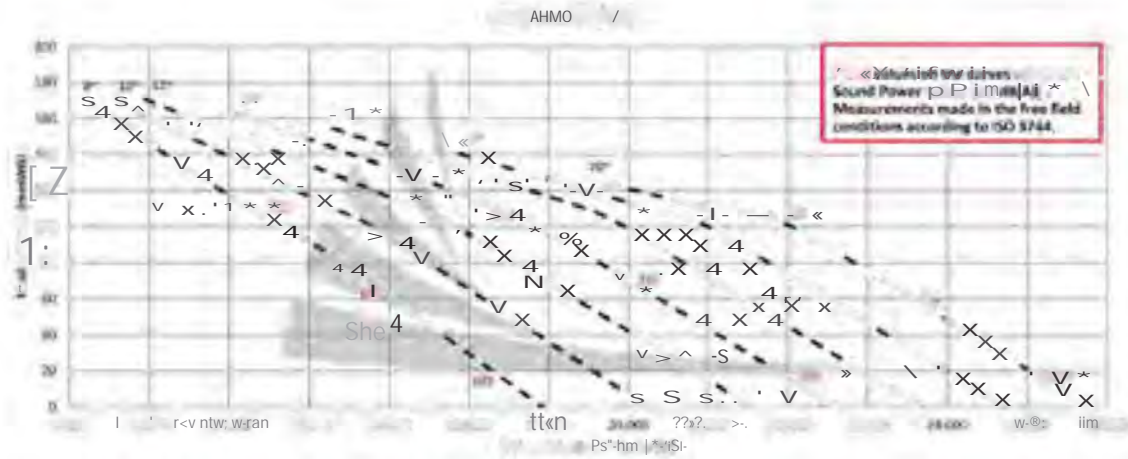

MMO-UIWUU

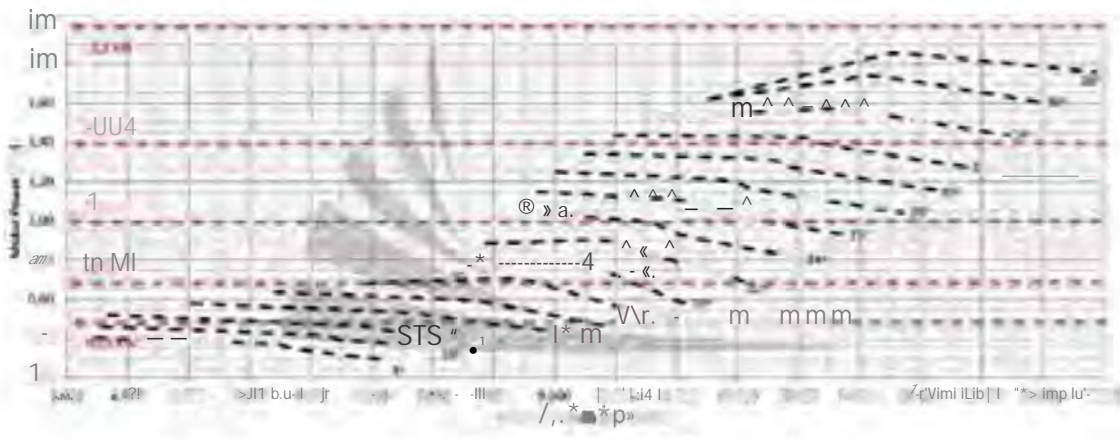
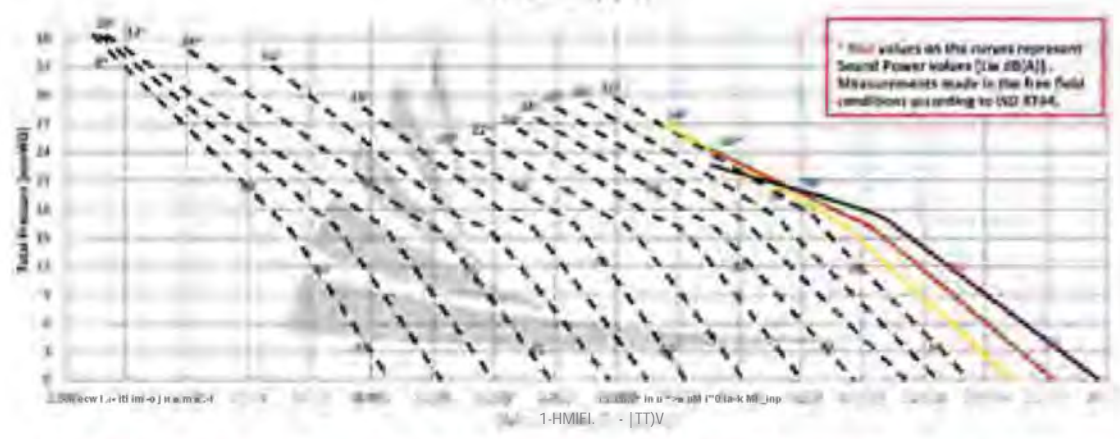

IPWUUAU

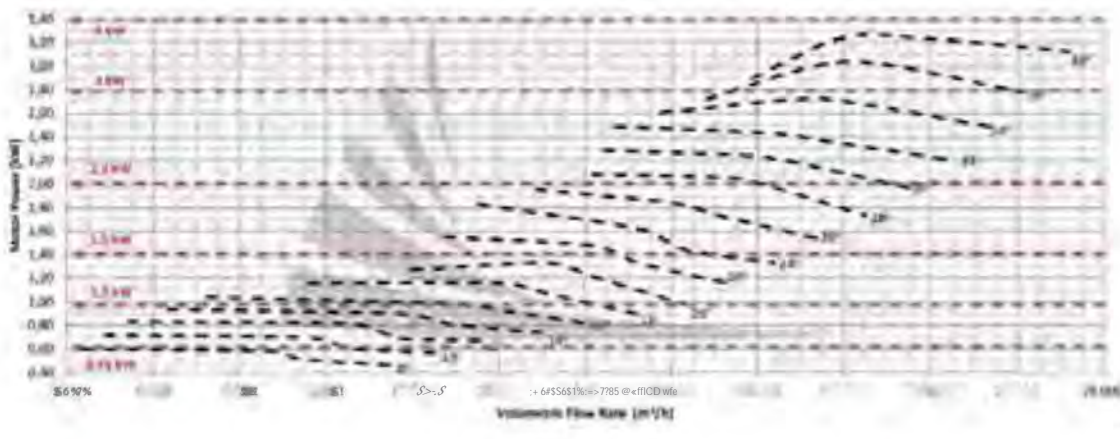
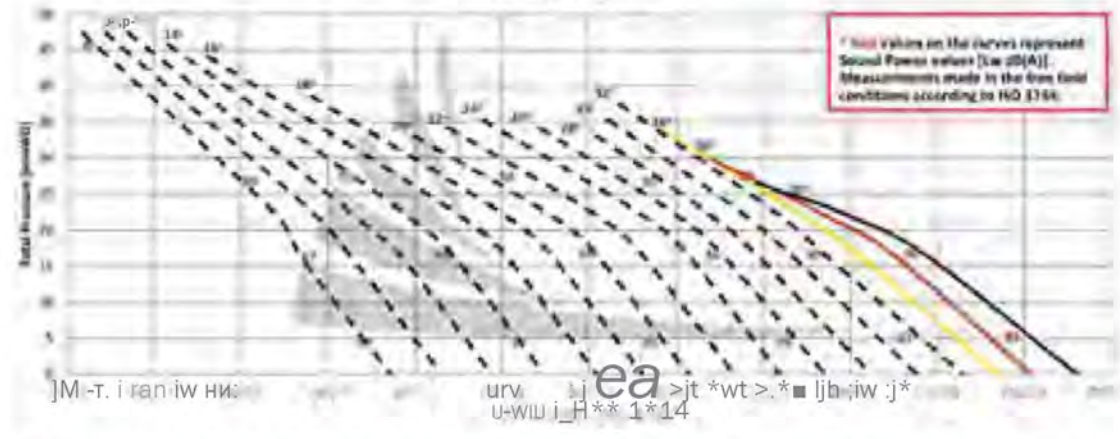

# SMOKE AND HEAT EXHAUST VENTILATION SYSTEMS

ARMO-4710/3/4A

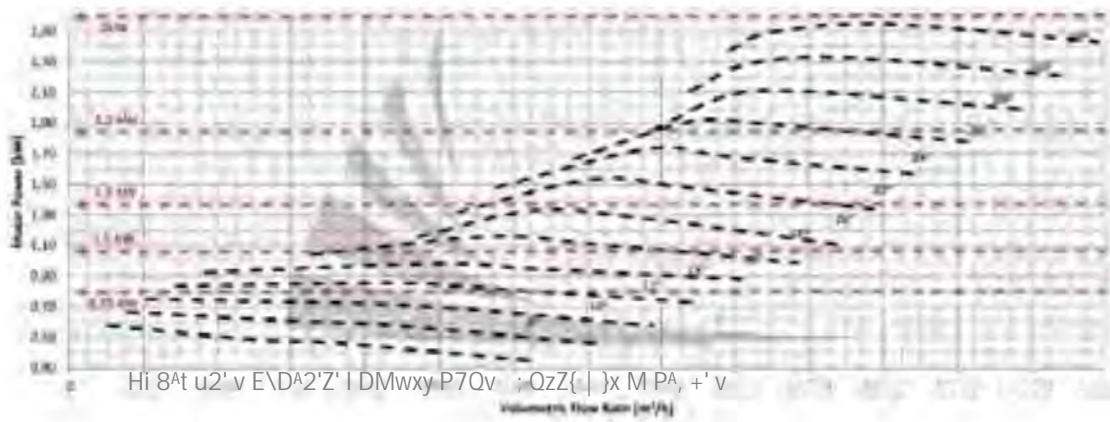
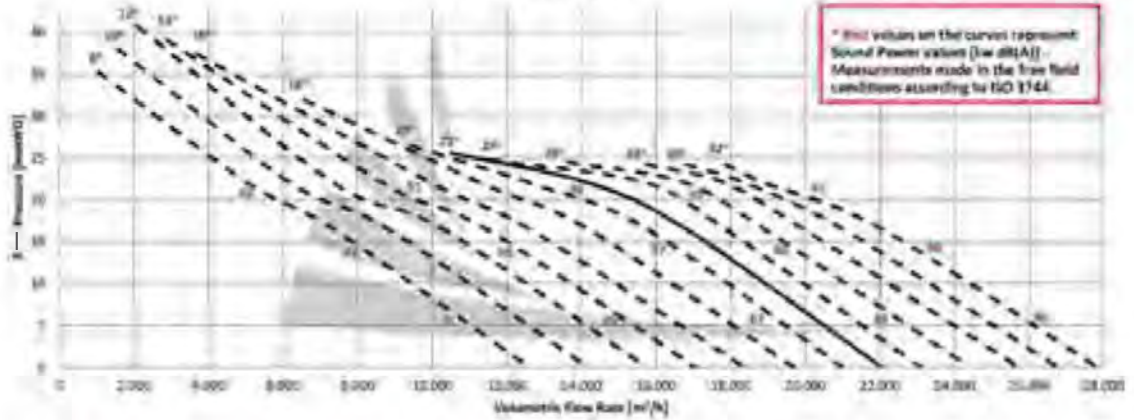

MMO-4710/1/4A

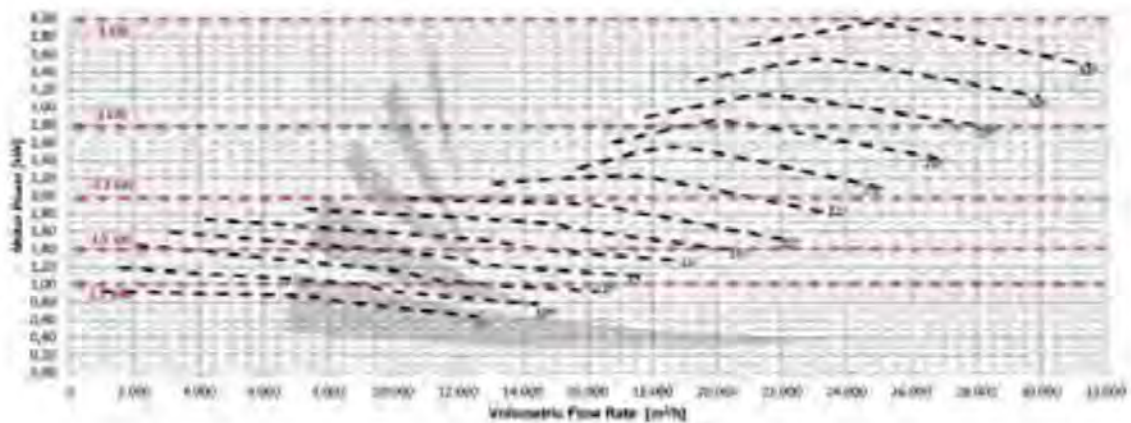
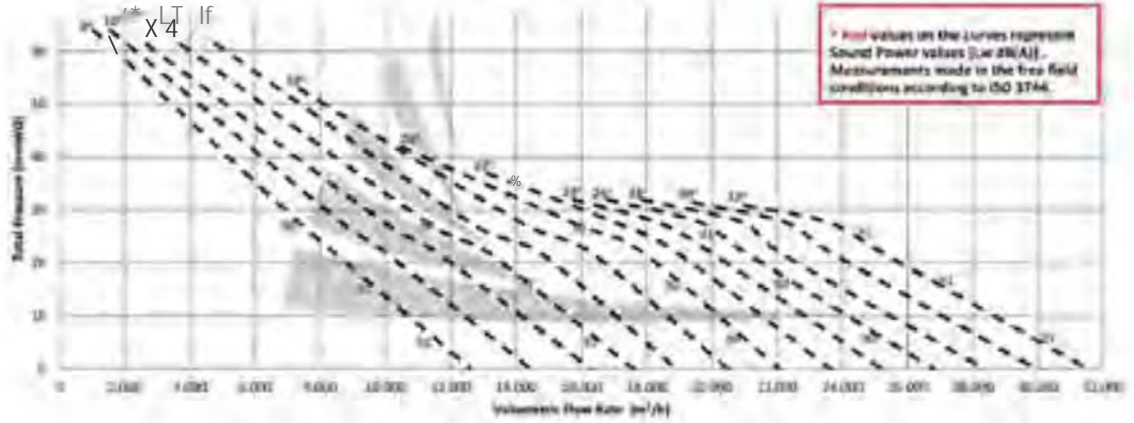

AJIMO / 4

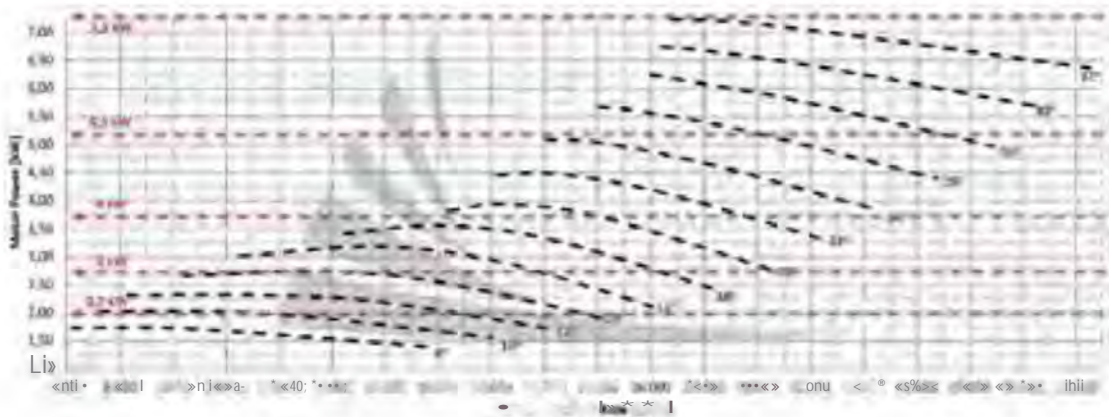
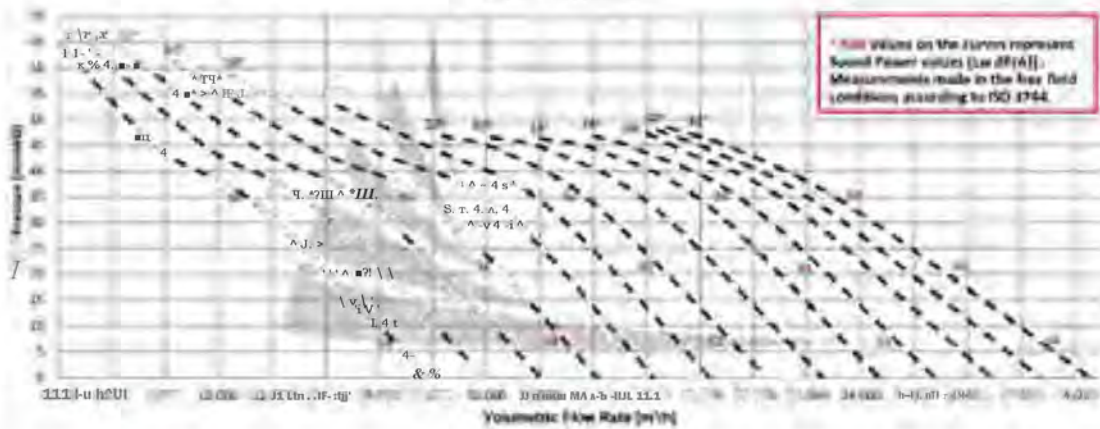

inwaiaw^/u

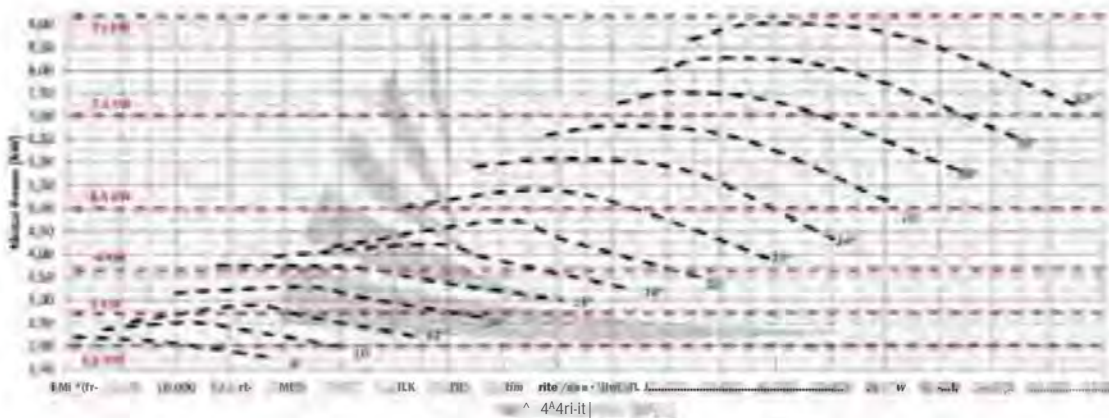
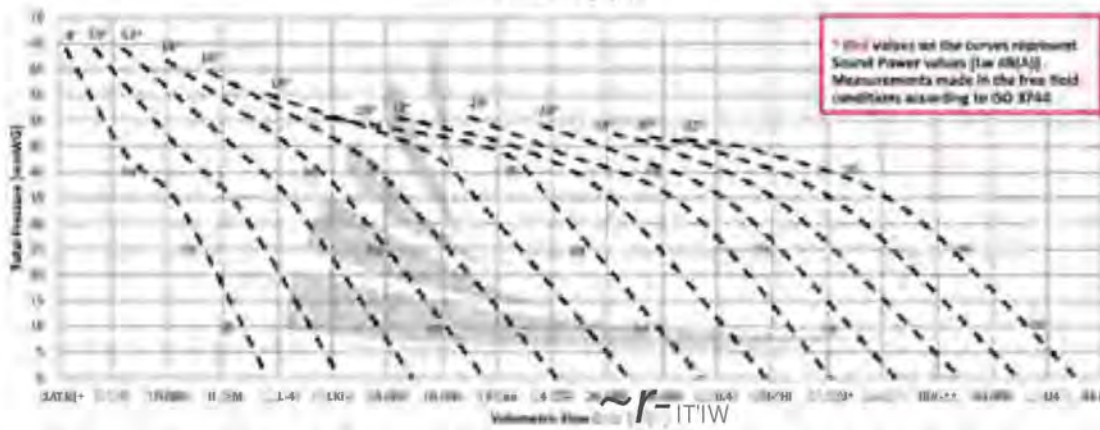

# SMOKE AND HEAT EXHAUST VENTILATION SYSTEMS

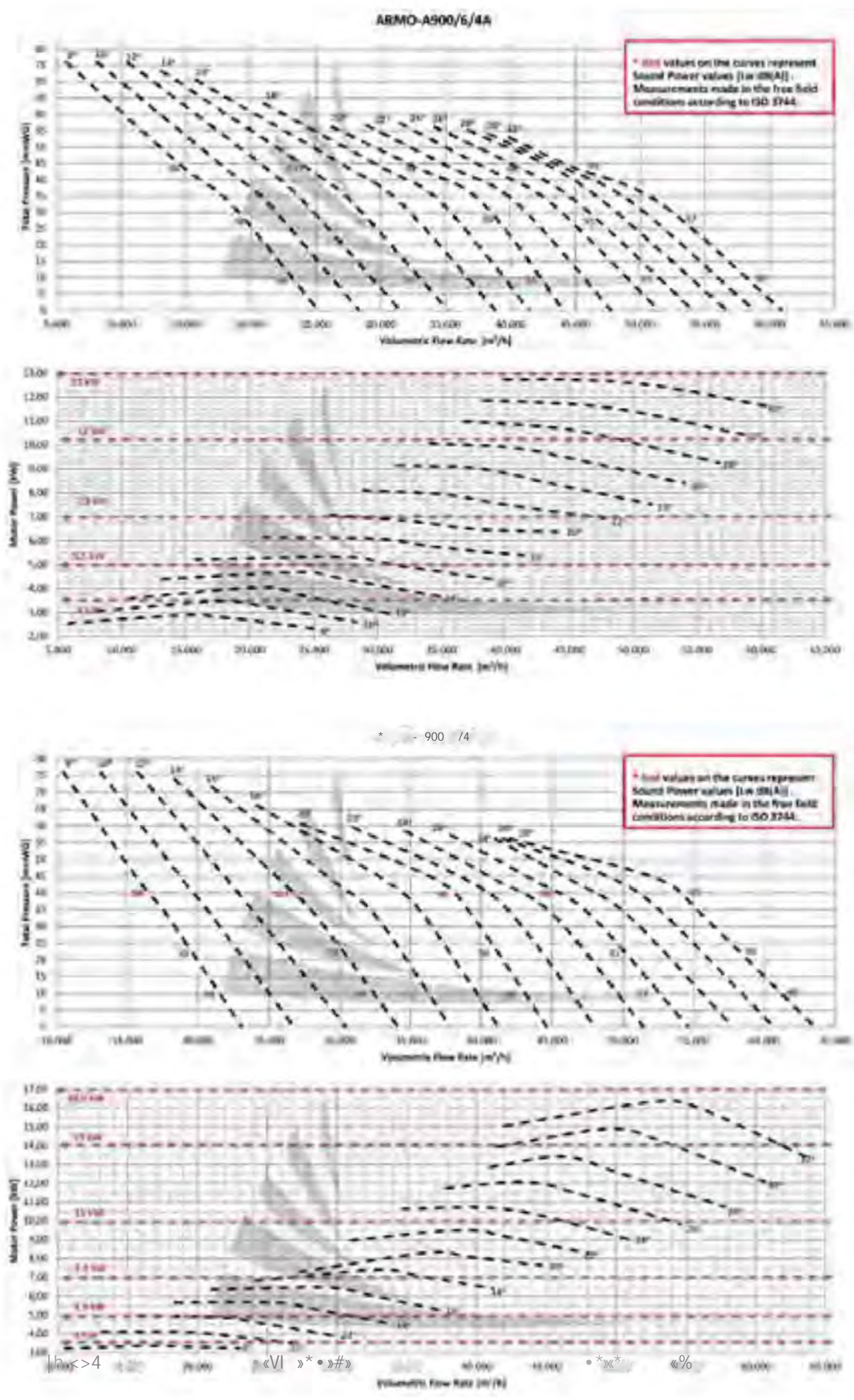

ARMO-A1000/6/4A

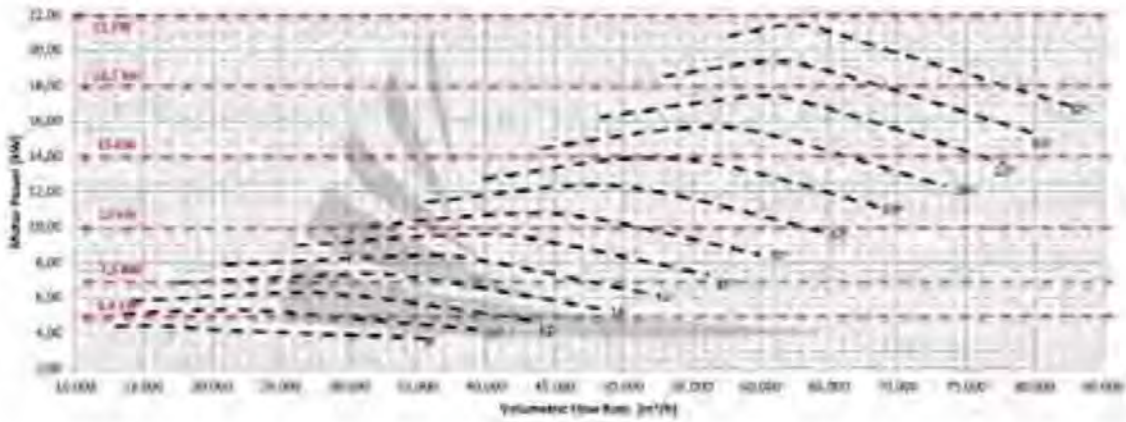
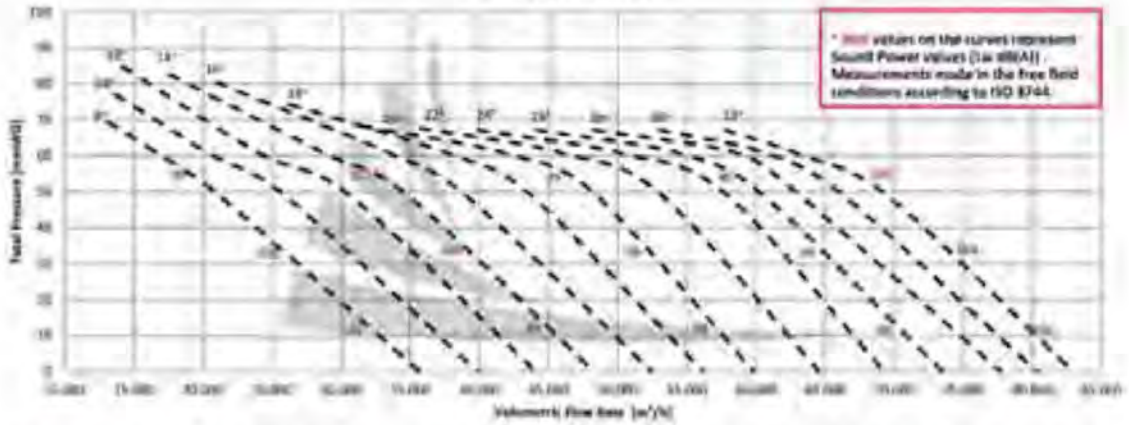

1 / 4

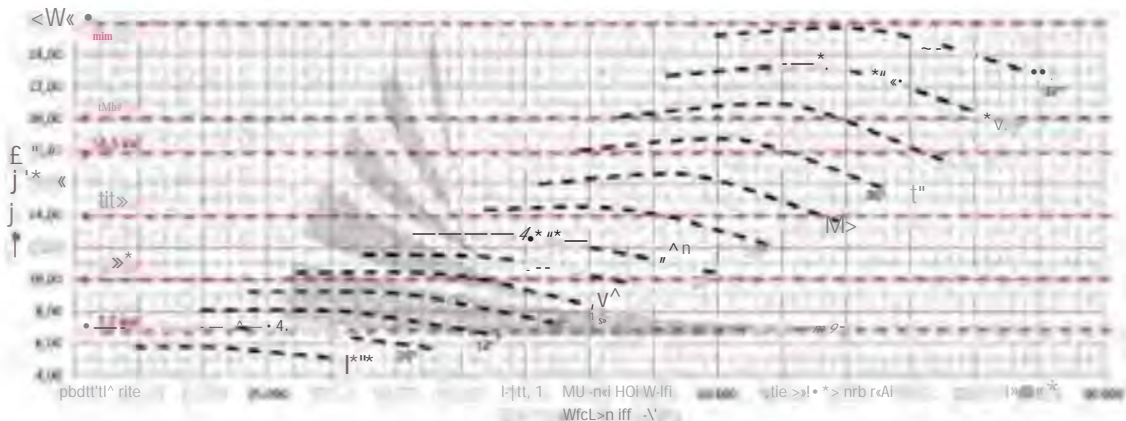
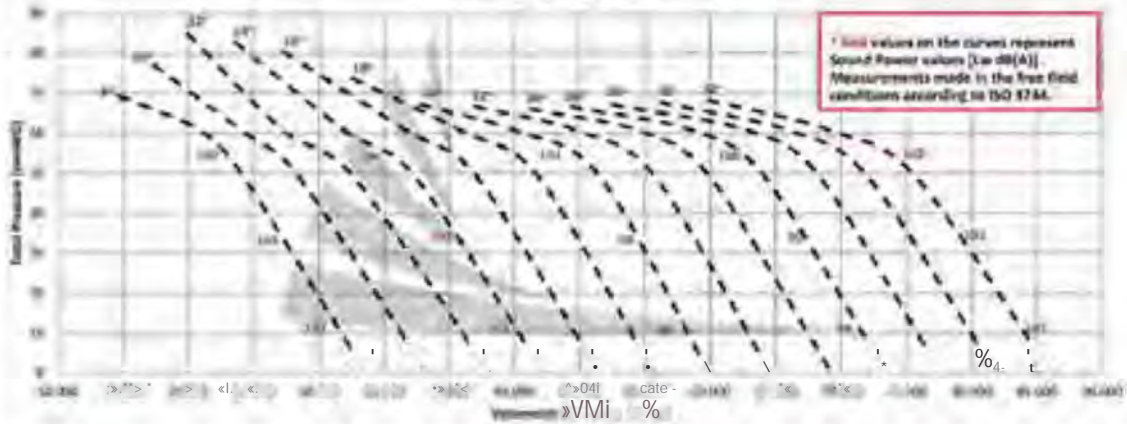



# SMOKE AND HEAT EXHAUST VENTILATION SYSTEMS

ARMO 4 /6/

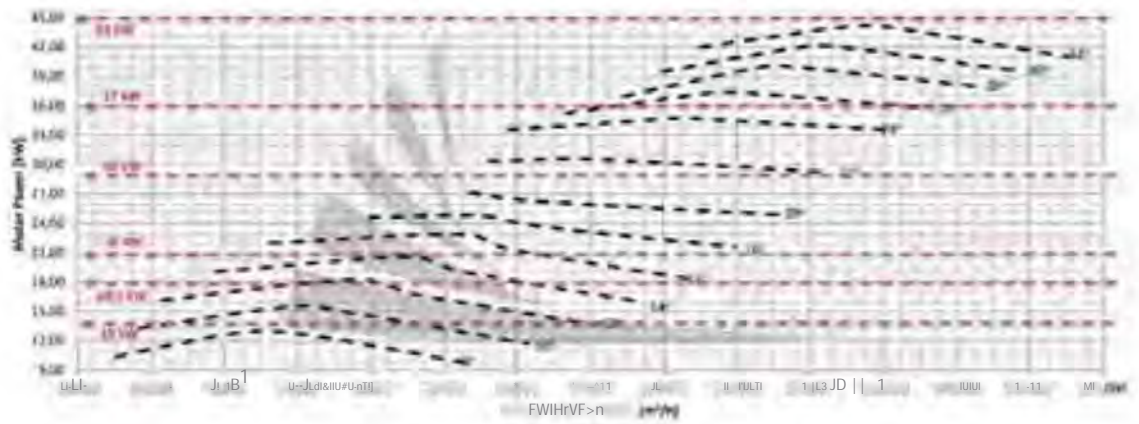
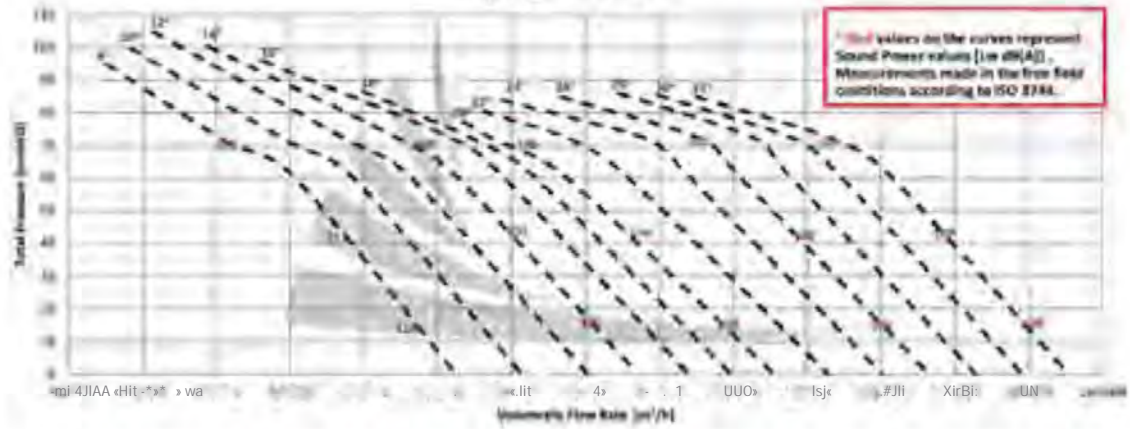

ARMO-A1250/9/4A

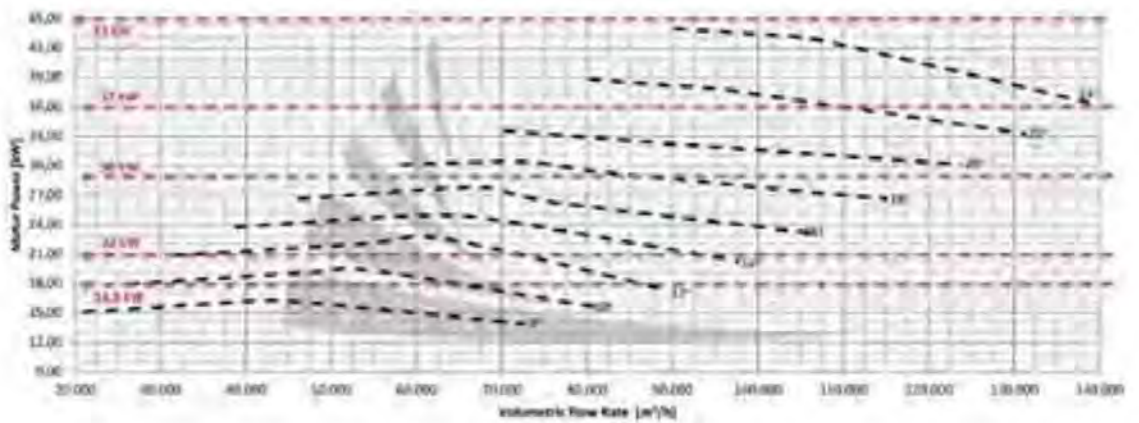
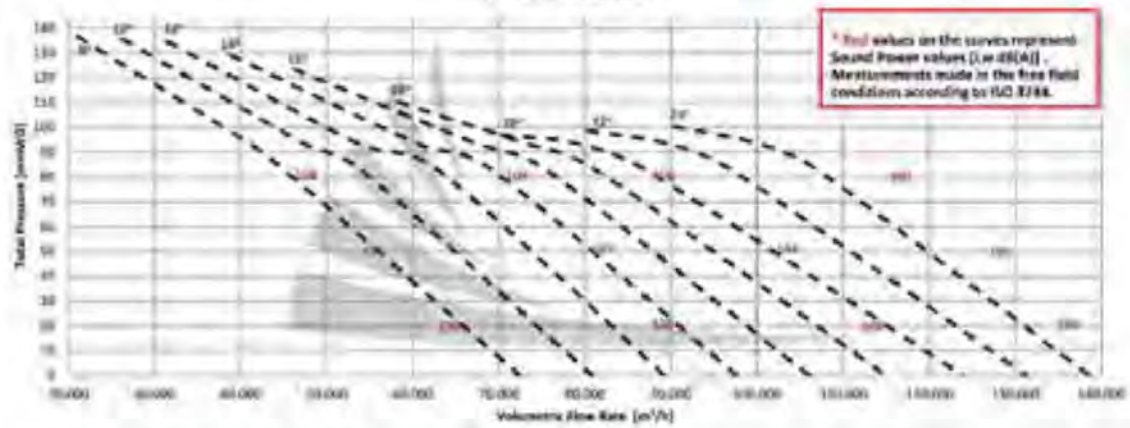

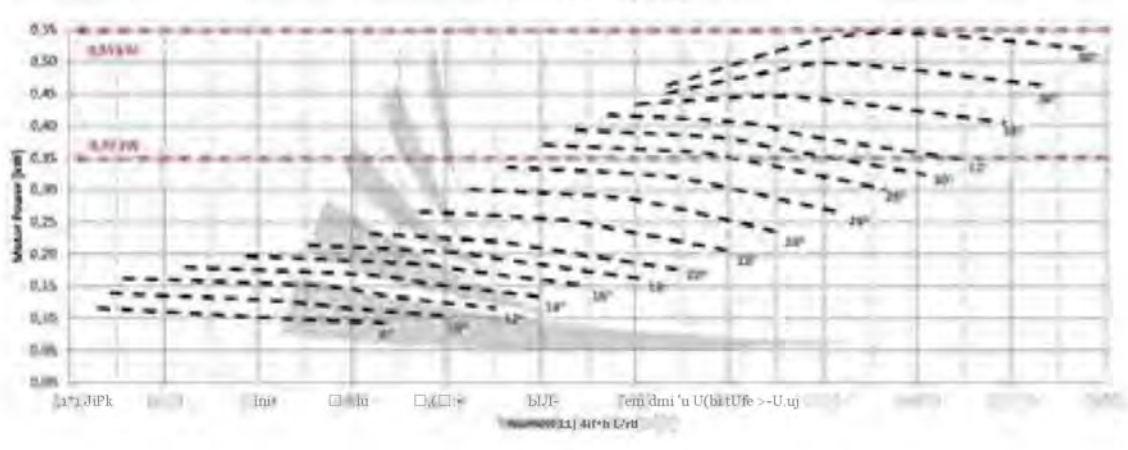
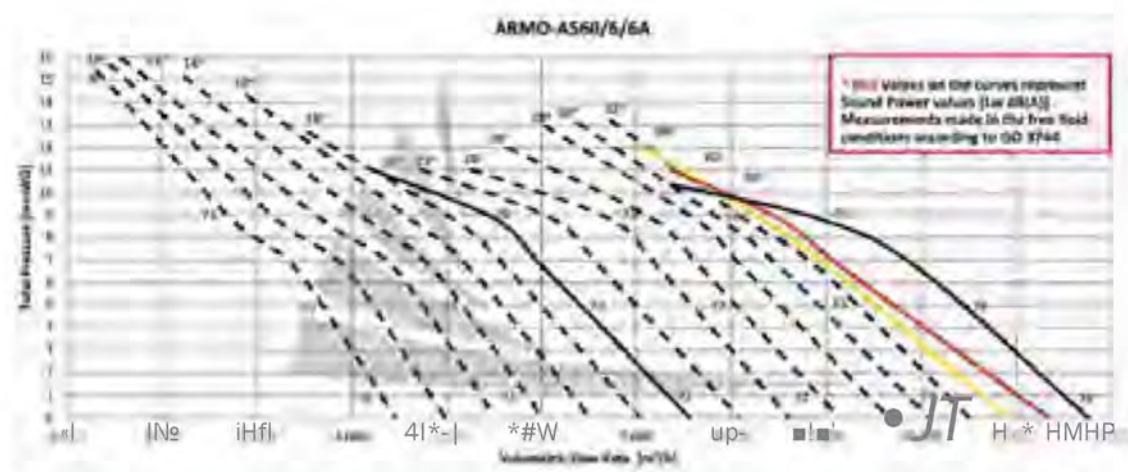
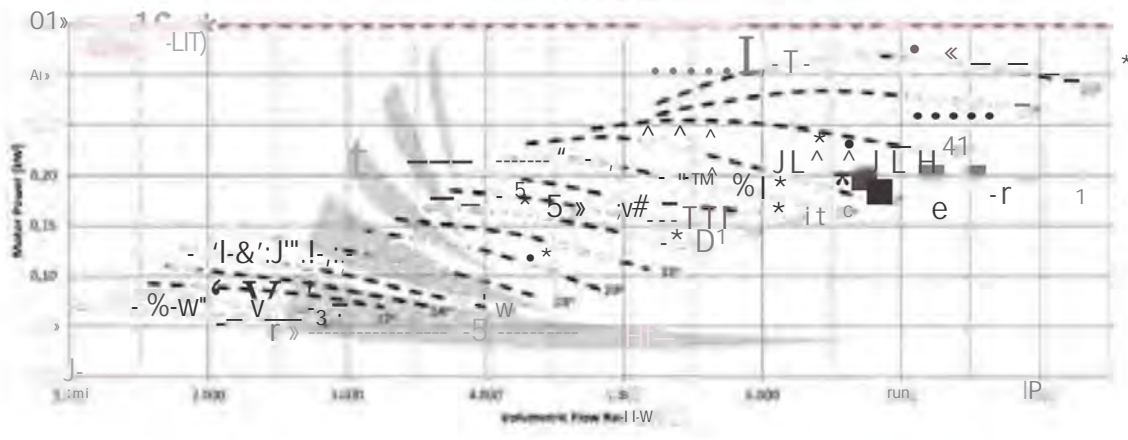
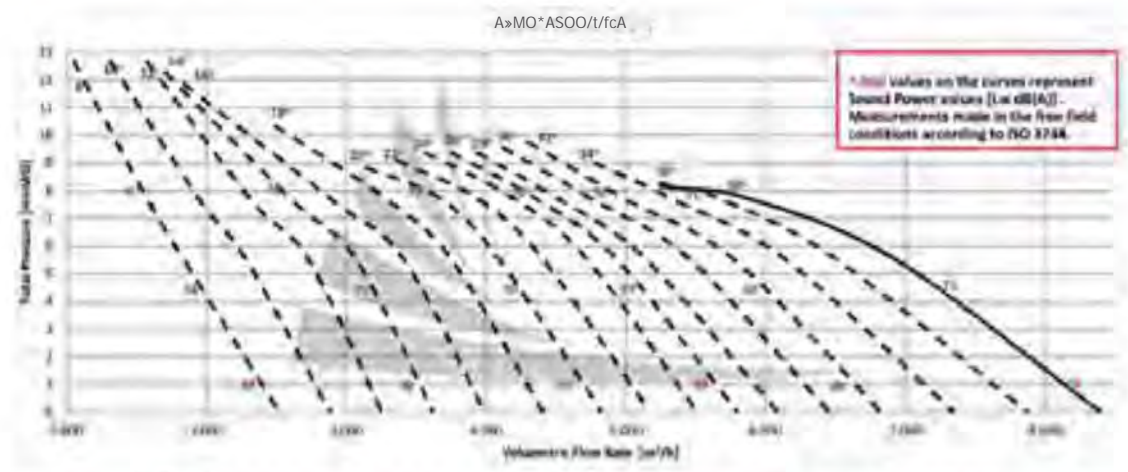

# SMOKE AND HEAT EXHAUST VENTILATION SYSTEMS

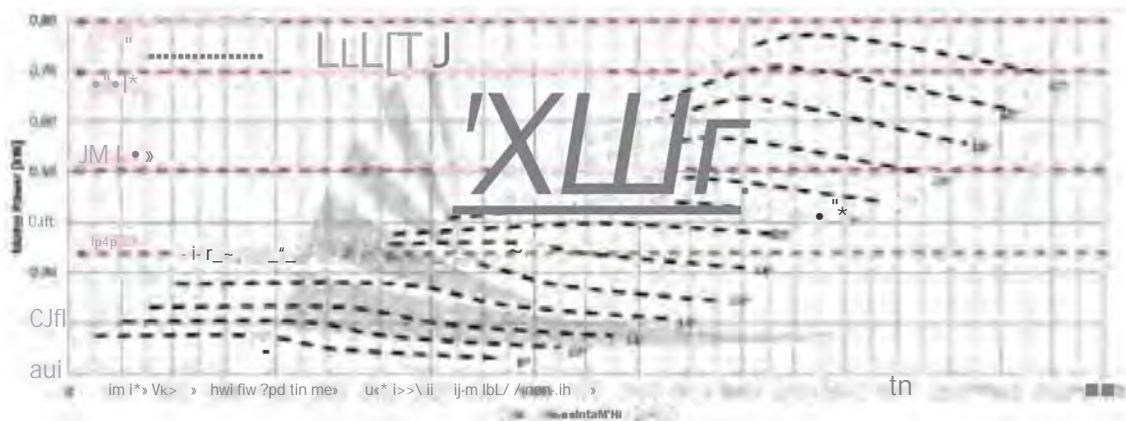
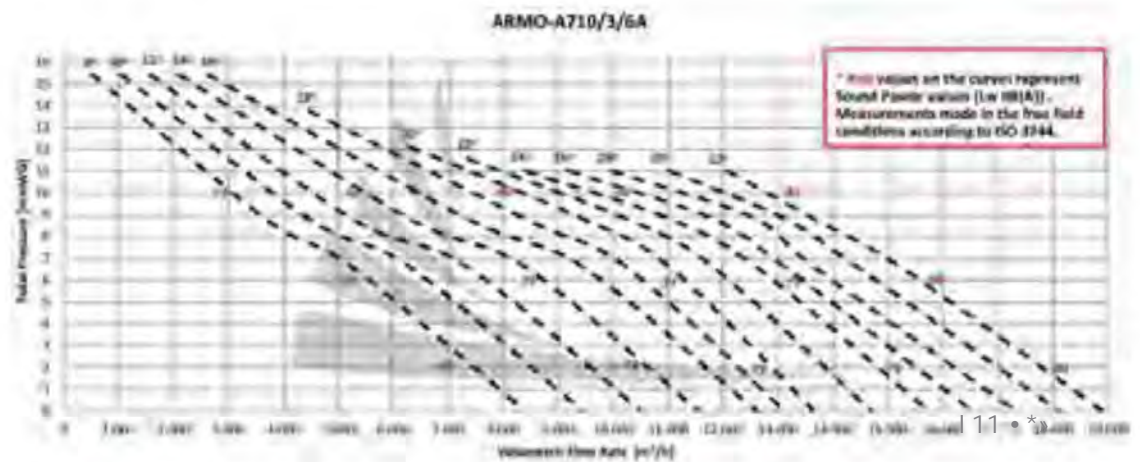
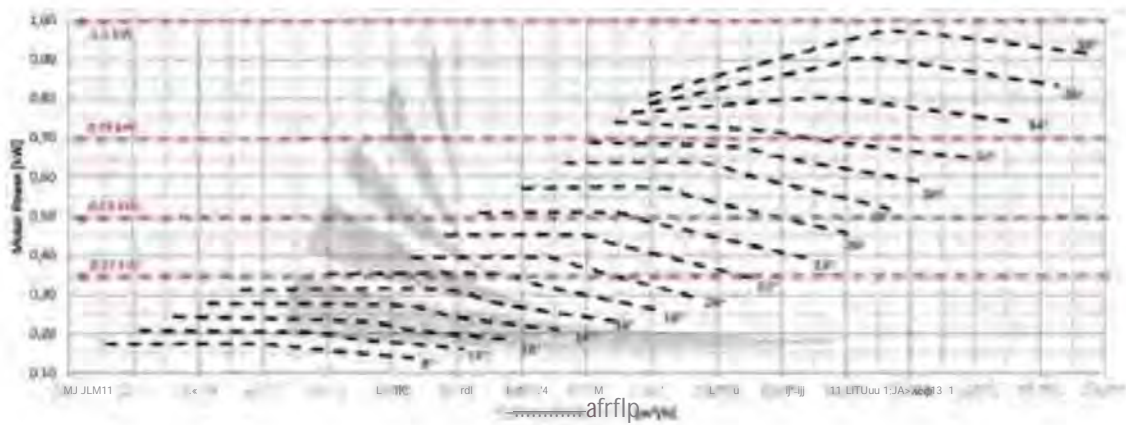
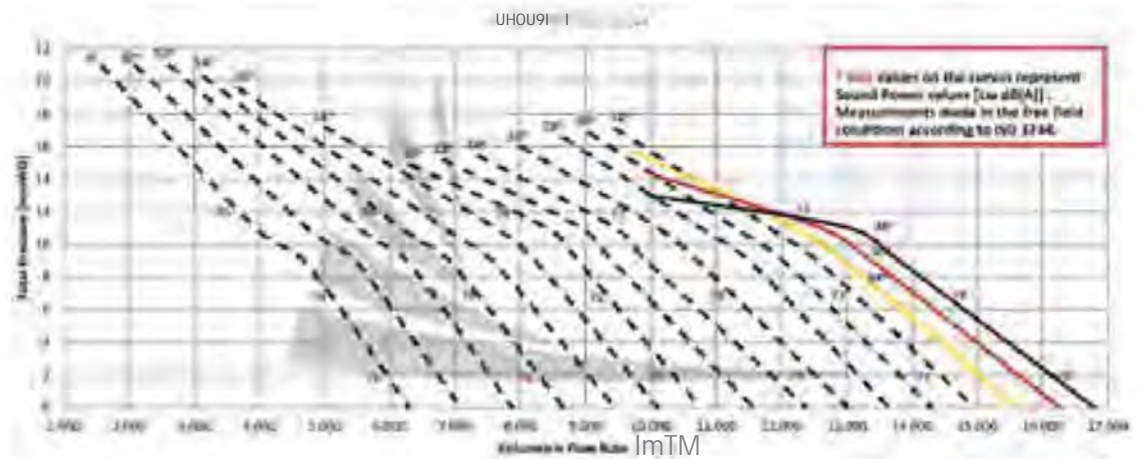

\*\*MO-A710/i/M

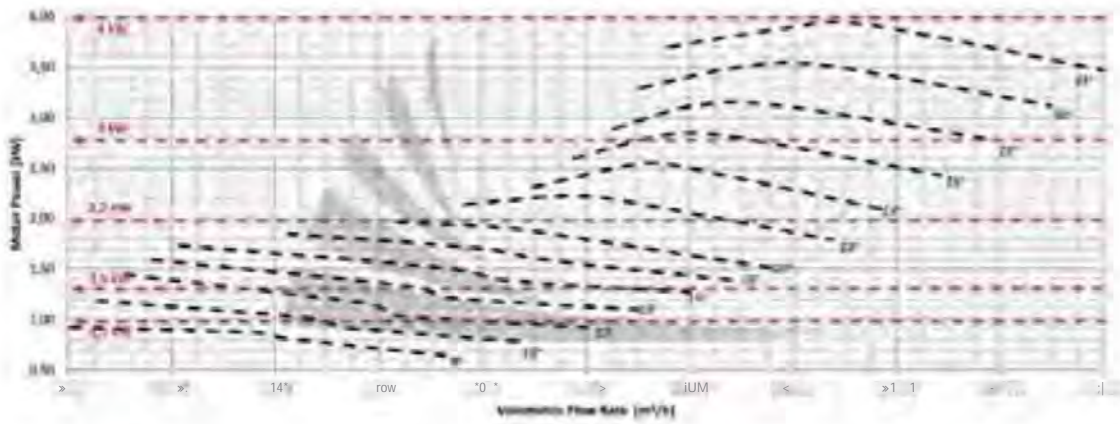
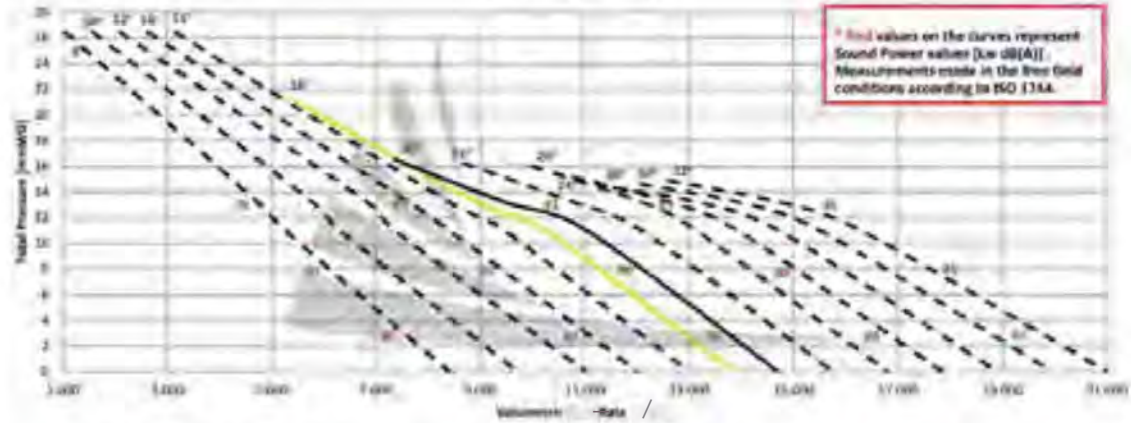

ARMO-AB00/5/6A

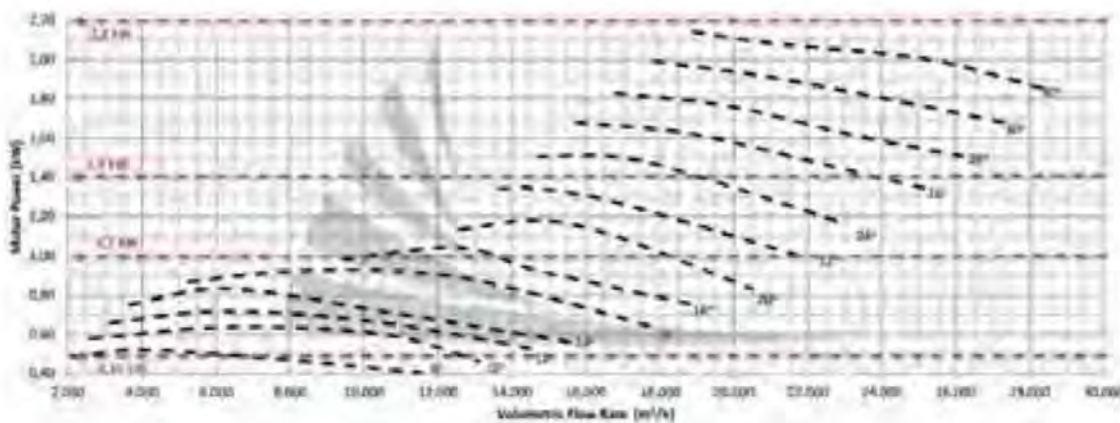
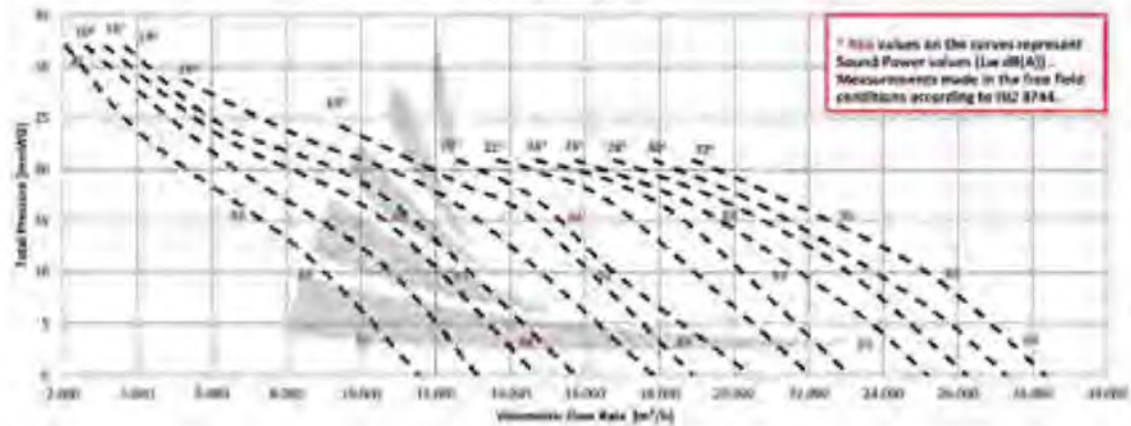

# SMOKE AND HEAT EXHAUST VENTILATION SYSTEMS

«MO-AS00/9/

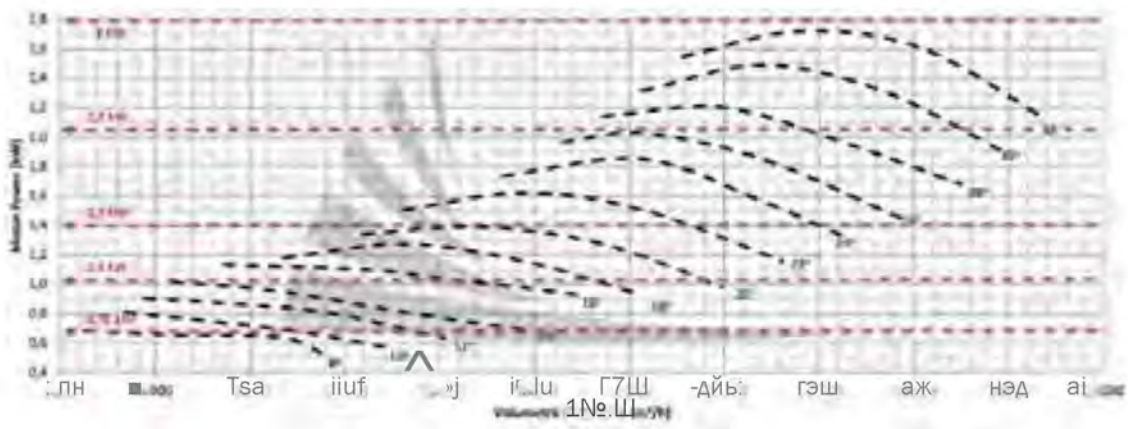
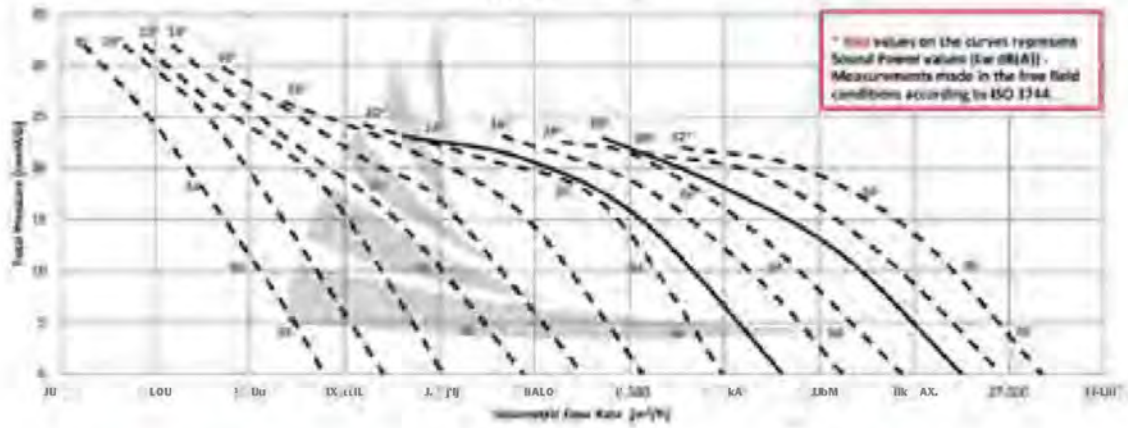

JKMO A900/t/1A

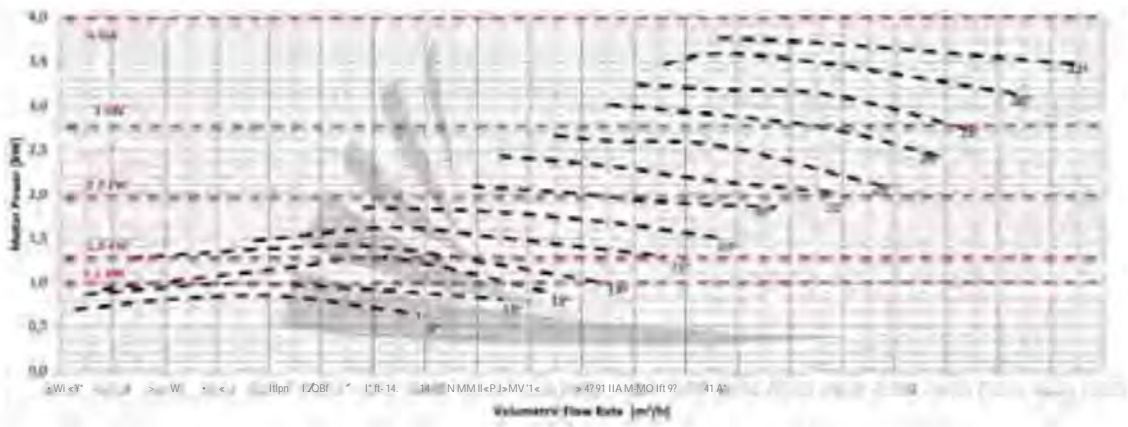
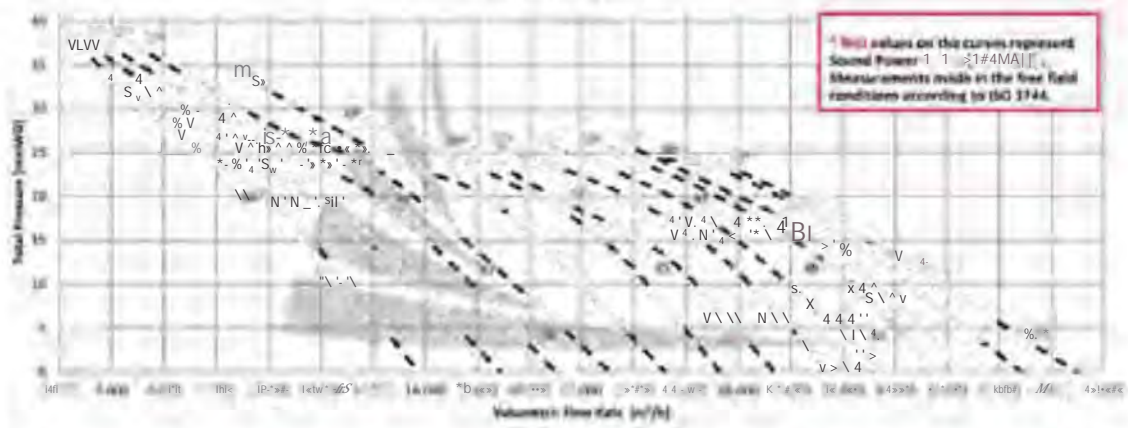

ARMO-A900/9/6A

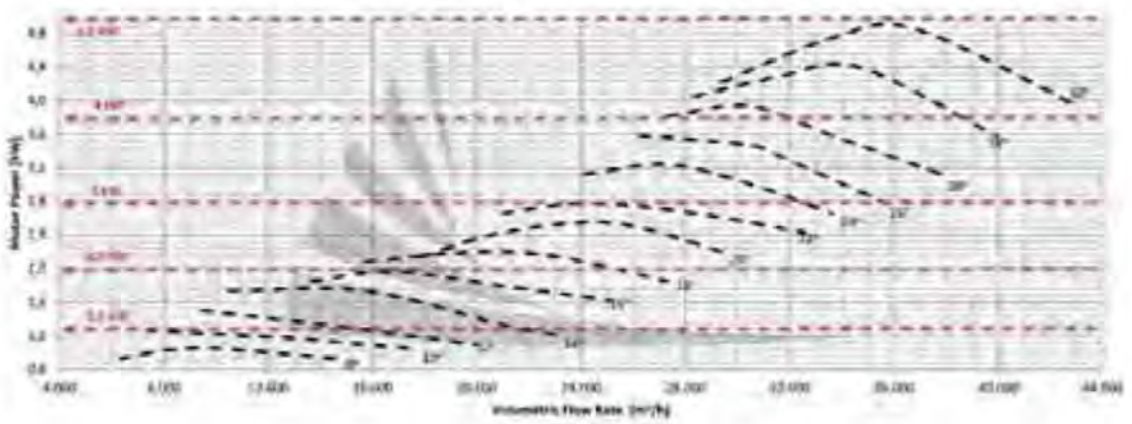
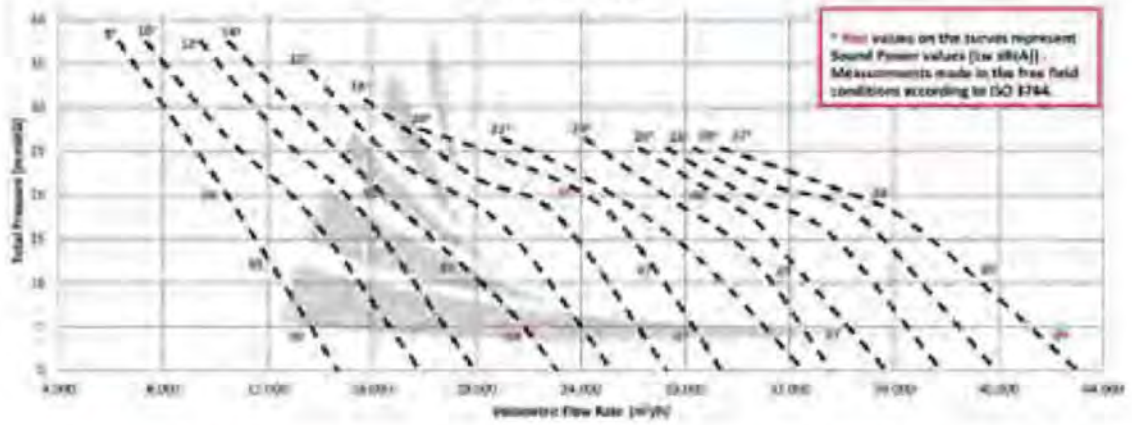

ARMO-A1000/6/6A

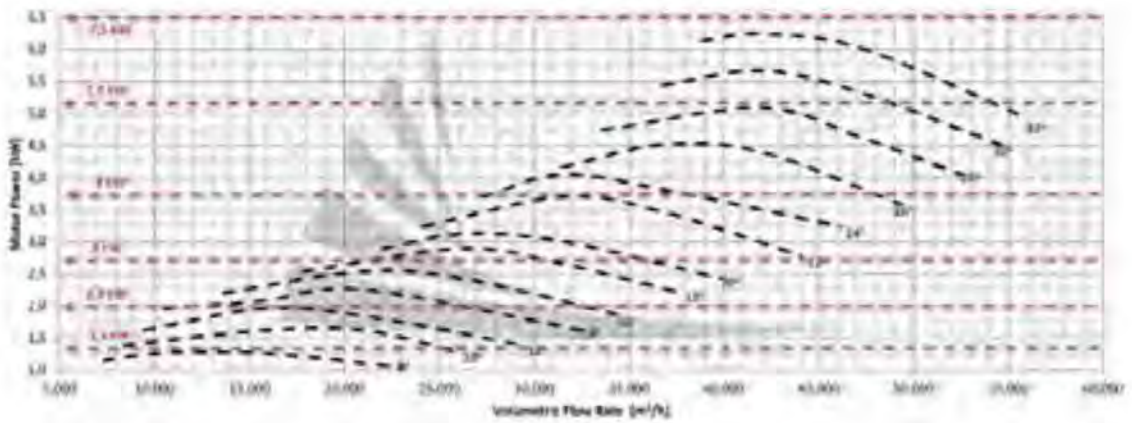
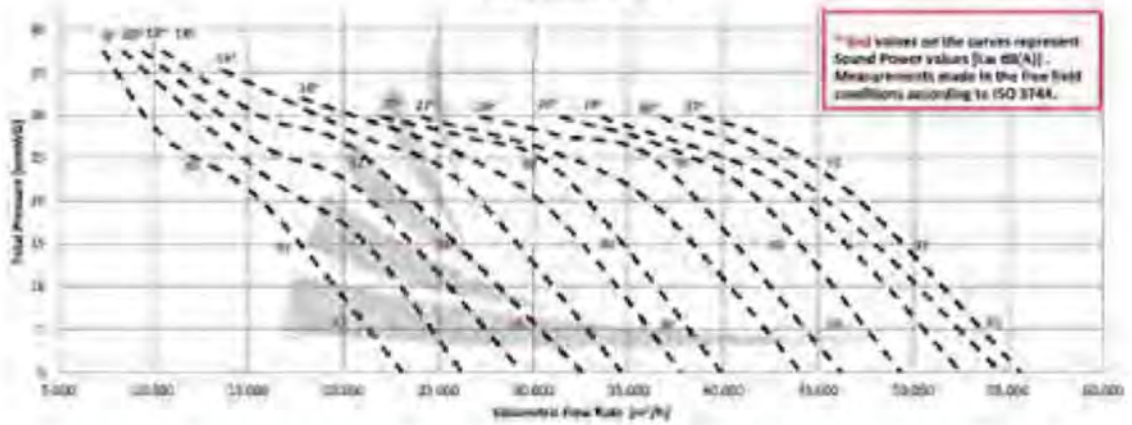

# SMOKE AND HEAT EXHAUST VENTILATION SYSTEMS

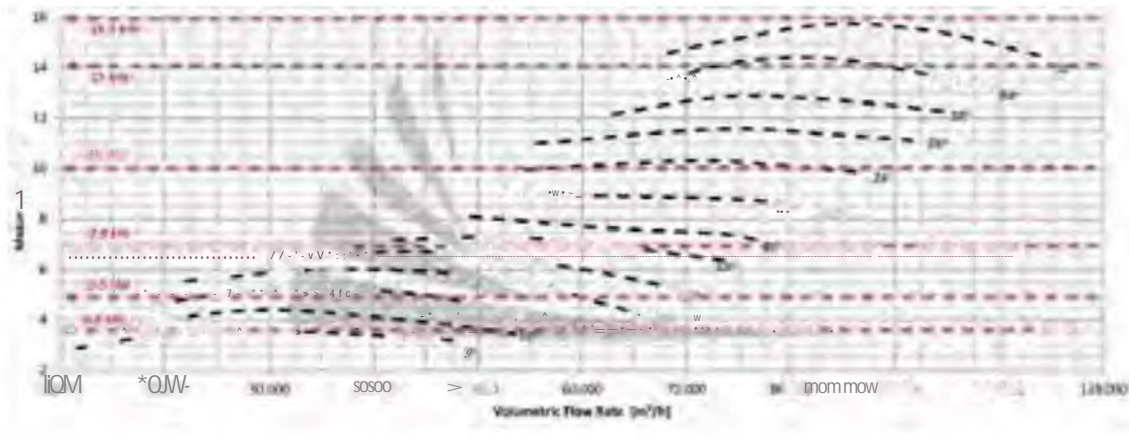
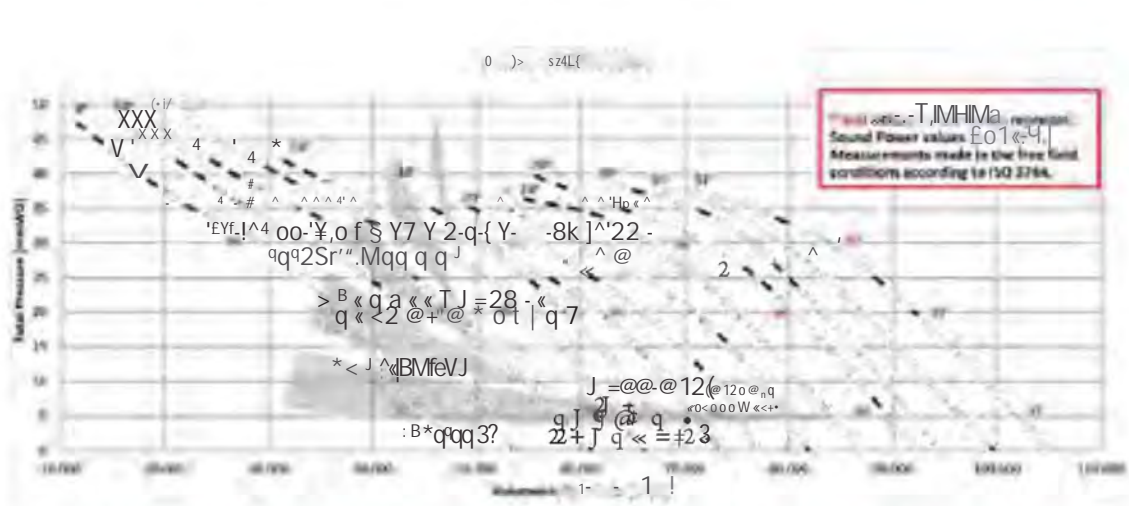
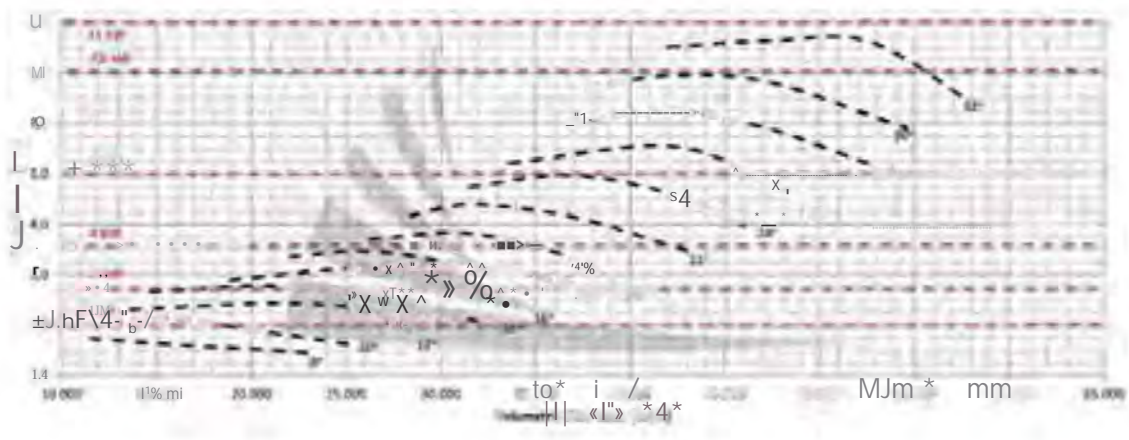
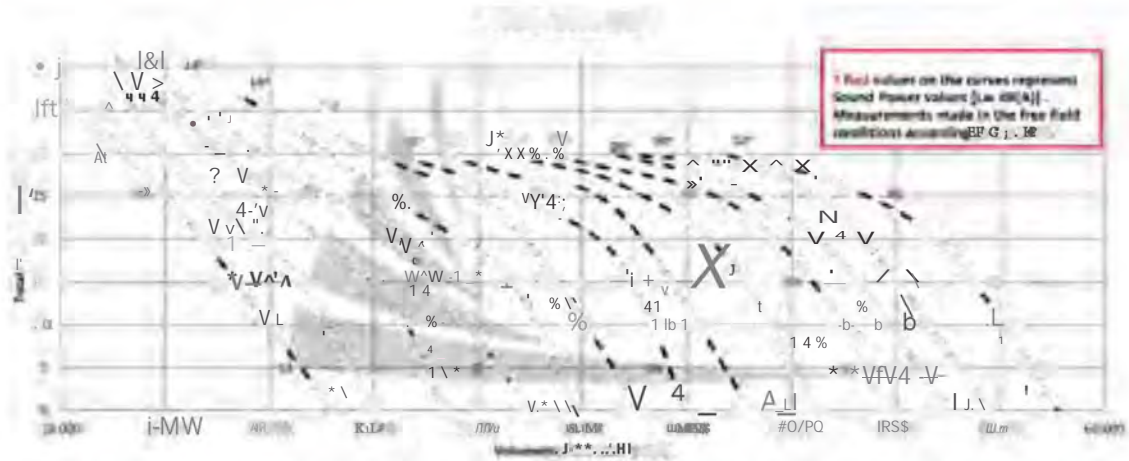

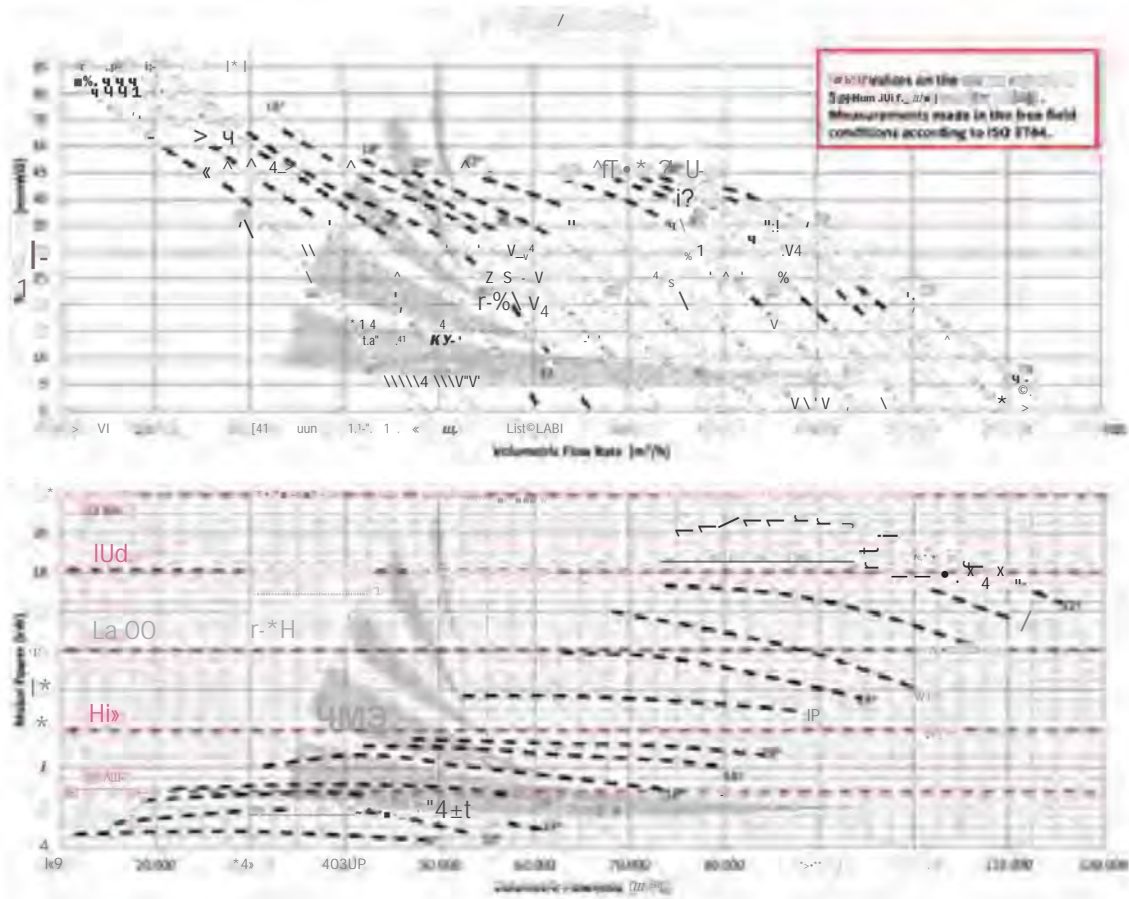

JET FAN CODES

CYLINDRICAL CASED AXIAL FAN CODES

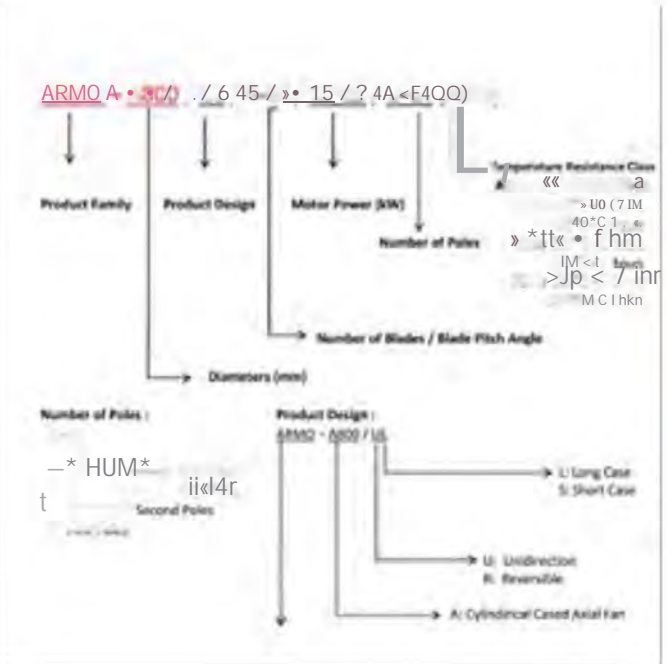
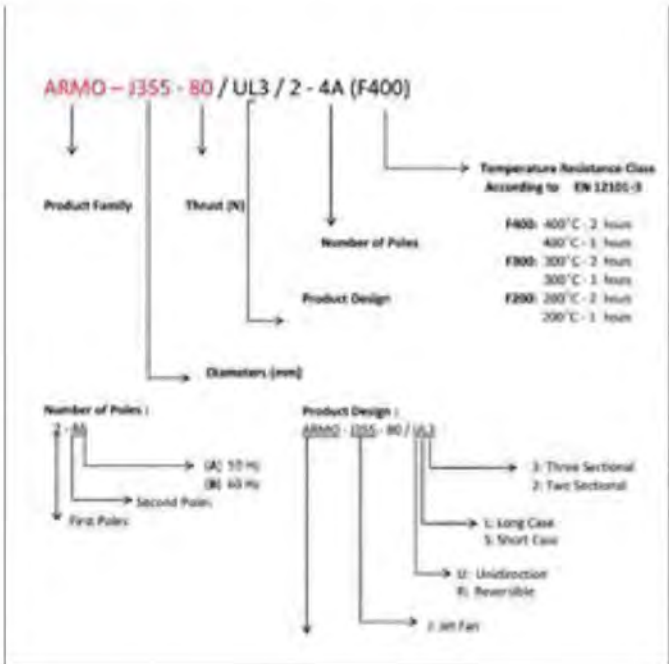



>wt ^

# ACCESSORIES

BSC

BSC-F

BYH

BASP

BDH

BDEB

BDKS

BYKS

BYF

BYEB



# ACCESSORIES



## BSC

SPEED CONTROL DEVICES  
0.2 - 5 Ampere

BSC can work under min. or max. voltage and controls speed.  
Dimensions: 116-114-50

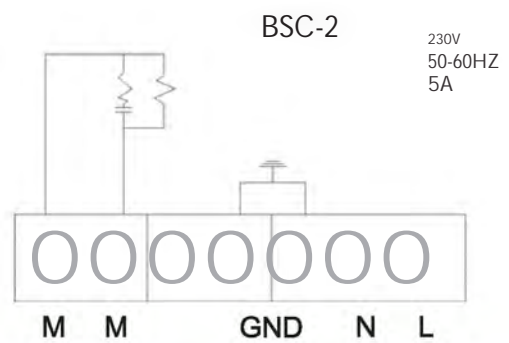
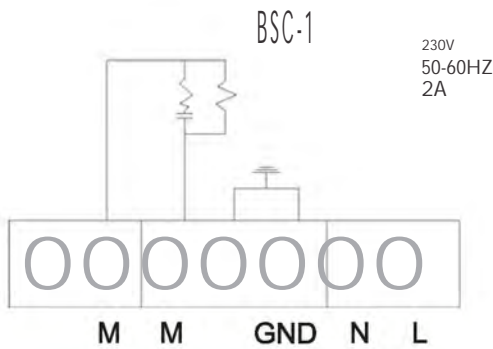

## BSC-F

FREQUENCY INVERTERS

0.75 - 22 Kw

BSC-F is a speed control device which works with IPM-SPWM which can adjust 3 Phase alternative current motor's speed from 0 to max. with a high speed momentum,

TYPE	POWER	V
	KW	
BSC-F-10	0.01....., 0.75	230
BSC-F-15	0.75....., 1.5	230
BSC-F-22	1.5....., 2,2	230
BSC-F-30	2.2....., 3	230
BSC-F-40	3....., 4	380
BSC-F-55 4....	....., 5 5	380
BSC-F-75 5.5.	....., 7.5	380
BSC-F-110	7.5 11	380
BSC-F-150.....	11 15	380
BSC-F-220	15....., 22	380

BSC-F is a motor speed control device which is customer oriented for an easy use of changing of motor's max. speed, slowing time, braking time and designed for variable electrical networks.

Between 0.75 Kw - 300 Kw

Energy savings at fan applications up to 50%, pump applications 30%. BSC-F has a compact structure and a self - cooling.

## BYH

CIRCULAR AIR REGULATORS

160 - 400

Made of galvanized sheet metal, provides to control air flowing.  
Two typed as manual controlling or automatic controlling.

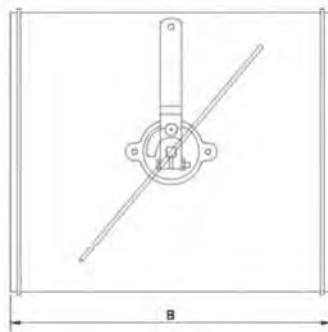
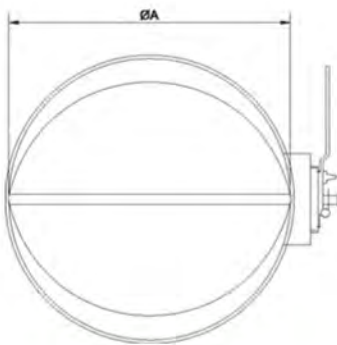

TYPE	Oa	
160	160	210
180	180	230
200	203	250
225	229	275
250	254	300
280	280	330
300	305	350
350	356	400
400	406	450

## BASP

ROUND METAL SHUTTERS

160 - 800

Made of galvanized sheet metal. Opens same direction with  
wind. When air flowing cuts off, stops air inside the system.

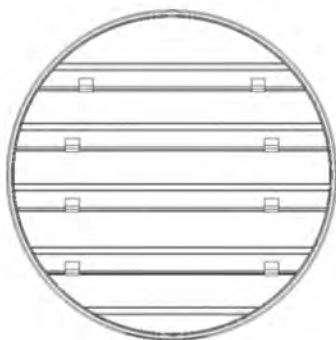

TYPE	A	
BASP 160	60	83
BASP 200	200	83
BASP 250	265	83
BASP 300	315	83
BASP 350	365	83
BASP 400	415	83
BASP 450	465	83
BASP 500	520	83
BASP 600	620	83
BASP 700	725	83
BASP 800	830	83

# ACCESSORIES



## BDH

RECTANGULAR AIR REGULATORS

100/200 - 2000/2000

BDH is manufactured with a type of aluminum extrusion.

Provides us to control air flowing. Two types as manual or automatic moving types.

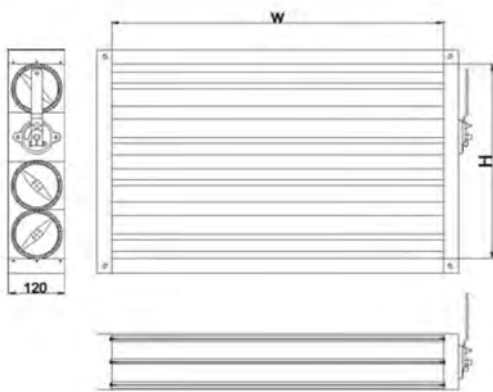

Can be manufactured to suit all types of our fans.



## BDEB

RECTANGULAR FLEXIBLE FLANGES

300/150 - 1000/500

BDEB is made of aluminum profile and canvas.

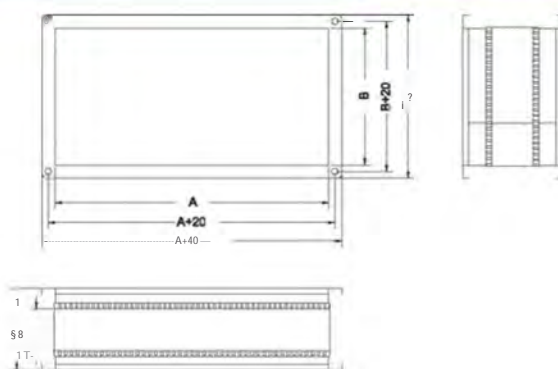

TYPE	A	
BDEB 30-15	300	150
BDEB 40-20	400	200
BDEB 50-25	500	250
BDEB 50-30	500	300
BDEB 60-30	600	300
BDEB 60-35	600	350
BDEB 70-40	700	400
BDEB 80-50	800	500
BDEB 100-50	1000	500

# BDKS

RECTANGULAR DUCT TYPE SILENCERS

300/150 -1000/500

BDKS decreases the noise level efficiently at duct fans. Noise decrease level is designed for the capacities asked for.



Noise Reduction Value (dB)

TYPE	H		Noise Reduction Value (dB)							
			125	250	500	1k	2k	4k	8k	
BDKS 30-15	300	150	7	15	18	25	25	19	19	
BDKS 40-20	400	200	5	9	15	23	16	12	10	
BDKS 50-25	500	250	10	15	25	25	20	15	12	
BDKS 50-30	500	300	8	15	20	31	17	14	11	
BDKS 60-30	600	300	8	15	20	31	17	14	11	
BDKS 60-35	600	350	7	13	17	18	13	10	8	
BDKS 70-40	700	400	7	11	14	14	10	8	6	
BDKS 80-50	800	500	6	8	10	11	8	6	3	
BDKS 100-501000		500	6	8	10	11	8	6	3	

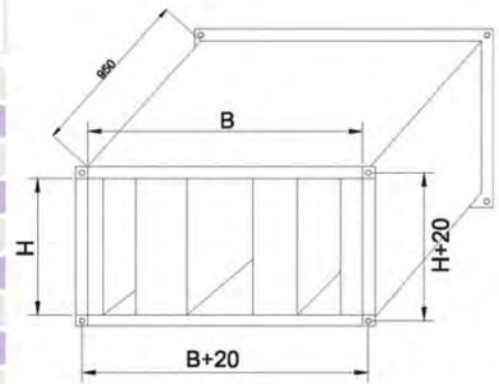

# BYKS

CIRCULAR DUCT TYPE SILENCERS

100 - 355

BYKS decreases the noise level efficiently at cylindrical duct fans. Noise decrease level is designed for the capacities asked for. 50 mm isolation.



Noise Reduction Value (dB)

TYPE	H		Noise Reduction Value (dB)									
			125	250	500	1k	2k	4k	8k			
BYKS	100	900	100	200	960	4	15	34	50	48	23	
BYKS	125	900	125	224	965	4	12	33	45	50	30	17
BYKS	150	900	150	250	965	4	10	28	42	43	20	15
BYKS	160	900	160	260	970	4	10	28	40	41	20	14
BYKS	200	900	200	300	985	4	8	24	32	34	13	10
BYKS	250	900	250	355	900	4	8	20	26	23	10	8
BYKS	315	900	315	415	900	3	7	16	22	12	6	7
BYKS 355	900	355		560	900	3	5	10	13	7	5	6

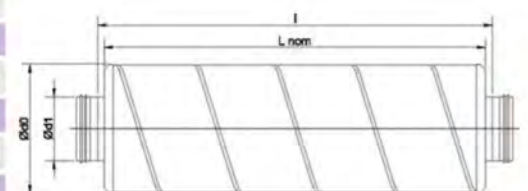

## ACCESSORIES



# BYF

## IN LINE DUCT FILTERS 200-315

As BDTX fans are used oily or dirty places, BYFs should be added. These filters hold oil to prevent motors to get harmed, impellers to get heavy and unbalanced in time. BYF is designed to be mounted inside duct fans.

TYPE	A			D	E
BYF 200	135	195	270	335	20
BYF 250	145	245	270	335	20
BYF 315	175	290	280	345	20

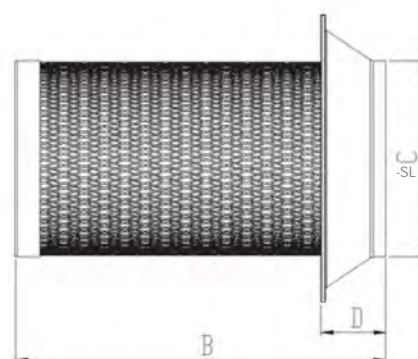
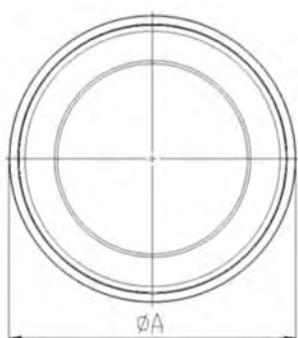

# BYE

CIRCULAR FLEXIBLE FLANGES

250 -1000

BYEB has flexible connections and is made of galvanized sheet material and has a neoprene fabric cover between 2 flanges.

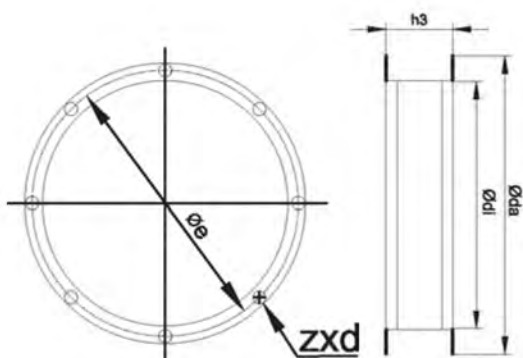

TYPE	oda	oe	odi	h3	zxd
BYEB 250	316	290	256	155	8 x 0 9 , 5
BYEB 280	345	320	286	155	8 x 0 9 , 5
BYEB 315	382	356	322	155	8 x 0 9 , 5
BYEB 355	421	395	361	155	8 x 0 9 , 5
BYEB 400	475	438	402	155	12x09,5
BYEB 450	524	478	453	155	12x09,5
BYEB 500	577	541	505	155	1 2 x 0 9 , 5
BYEB 560	652	605	569	155	16x012
BYEB 630	723	674	638	155	16x012
BYEB 710	802	751	712	155	16x012
BYEB 800	890	837	797	155	2 4 x 0 1 2
BYEB 900	1000	934	894	160	2 4 x 0 1 2
BYEB 1000	1090	1043	1003	165	24x012



DUCT FANS

ROOF FANS

AXIAL FANS

RADIAL FANS

PLASTIC FANS

VENTILATORS

SMOKE EXHAUST SYSTEMS

ACCESSORIES



(8182)63-90-72  
+7(7172)727-132  
(4722)40-23-64  
(4832)59-03-52  
(423)249-28-31  
(844)278-03-48  
(8172)26-41-59  
(473)204-51-73  
(343)384-55-89  
(4932)77-34-06  
(3412)26-03-58  
(843)206-01-48

(4012)72-03-81  
(4842)92-23-67  
(3842)65-04-62  
(8332)68-02-04  
(861)203-40-90  
(391)204-63-61  
(4712)77-13-04  
(4742)52-20-81  
(3519)55-03-13  
(495)268-04-70  
(8152)59-64-93  
(8552)20-53-41

(831)429-08-12  
(3843)20-46-81  
(383)227-86-73  
(4862)44-53-42  
(3532)37-68-04  
(8412)22-31-16  
(342)205-81-47  
- - (863)308-18-15  
(4912)46-61-64  
(846)206-03-16  
- (812)309-46-40  
(845)249-38-78

(4812)29-41-54  
(862)225-72-31  
(8652)20-65-13  
(4822)63-31-35  
(3822)98-41-53  
(4872)74-02-29  
(3452)66-21-18  
(8422)24-23-59  
(347)229-48-12  
(351)202-03-61  
(8202)49-02-64  
(4852)69-52-93